

1
2
3
4 **BEFORE THE HEARING EXAMINER OF THE CITY OF MERCER ISLAND**

5
6 NOTICE OF APPEAL
7 IN RE: NOTICE OF DECISION: FILE NO.
8 2207-019

Case No. _____

8 DANIEL GROVE,

9 Appellant,

APPELLANT DANIEL GROVE'S
NOTICE OF APPEAL OF BUILDING
PERMIT NO. 2207-019

10 v.

11 CITY OF MERCER ISLAND,

12 Respondent.
13

14
15 **I. INTRODUCTION**

16 This is an action to stop an illegal construction project that grossly violates the Mercer
17 Island City Code. Building Permit 2207-019 (“Permit 2207-019”) proposes to demolish an existing
18 house and build a new, larger home along with accessory structures at 6950 SE Maker Street on
19 Mercer Island, Washington. On February 20, 2024, the City of Mercer Island (“City”) approved
20 Permit 2207-019 despite considerable evidence demonstrating that the proposal fails to comply
21 with existing rules and regulations. The City’s approval is in substantial error and is unsupported
22 by the evidence in the record.

23 **II. IDENTITY OF APPELLANT AND STANDING**

24 Appellant, Daniel Grove, lives immediately adjacent to the demolition and redevelopment
25 proposed at 6950 SE Maker Street, on Mercer Island, Washington. Mr. Grove resides at 3515 72nd
26 Ave SE on Mercer Island, Washington. Approval of Permit 2207-019 will result in an out of scale

1 and oversized house that will directly injure Mr. Grove’s property and reduce its value.

2 **III. DECISION BEING APPEALED**

3 Mr. Grove appeals the City’s Notice of Decision: File No. 2207-019 (“Notice of Decision”)
4 which approves Permit 2207-019 subject to conditions. A copy of the Notice of Decision is
5 attached to this appeal as Exhibit A.

6 **IV. LEGAL AUTHORITY**

7 Pursuant to Mercer Island City Code (“MICC”) 19.15.130, a decision may be
8 administratively appealed by filing a written appeal on the decision. The burden of proof is on the
9 appellant to demonstrate that there has been substantial error, or the proceedings were materially
10 affected by irregularities in procedure, or the decision was unsupported by evidence in the record,
11 or that the decision is in conflict with the standards for review of the particular action. MICC
12 19.15.130.C. Here, the City’s decision is both in substantial error and unsupported by the evidence
13 in the record. Upon review, the Hearing Examiner may remand the decision back to the City for
14 further consideration. MICC 3.40.020. Mr. Grove respectfully requests the Hearing Examiner do
15 so in this case, as further detailed below.

16 **V. SUMMARY OF PROCEDURAL BACKGROUND**

17 In July 2022, Jeffrey Almeter, on behalf of Ms. Dorothy Strand (“Applicants”), submitted
18 a building permit application and associated site plans to demolish the existing single-family
19 residence at 6950 SE Maker Street and construct a new, 3,936 square foot single-family residence
20 with an accessory dwelling unit. *See* Exhibit B (Building Permit Application). During the public
21 comment period, several neighbors, including Mr. Grove, submitted comment letters to express
22 their concerns about the development including the drastic changes in size of the home, failure to
23 comply with Mercer Island City Code requirements, and several safety concerns due to the
24 development being located within geologically hazardous areas.¹ Mr. Grove specifically raised the
25

26 ¹ Public comment letters can be located on Mercer Island’s public permit portal at:
<https://mieplan.mercergov.org/public/2207-019/Public%20Comments/>

1 following concerns related to the: (1) miscalculation of elevation and existing grade, (2)
2 miscalculation of gross floor area, and (3) miscalculation of the home’s building and facade height.
3 Mr. Grove also raised the issues of (4) the safety and legality of the proposed perimeter rockery,
4 and (5) severe damage to a tree designated as an “Exceptional Tree” in Mercer Island to enable the
5 proposed demolition and rebuild of the proposed. *See* Exhibit C (Comment Letters).

6 The City responded with comments to the Applicants on November 18, 2022 and in
7 response to those and subsequent comments, the Applicants submitted several more iterations of
8 the Development Plan Set, culminating with the most recent Development Plan Set dated June 2,
9 2023 (“Final Plan Set”). *See* Exhibit D (Final Plan Set, June 2, 2023). The City’s Notice of
10 Decision relies on this Final Plan Set, which contains several errors.

11 The Final Plan Set still contains four main errors in violation of Mercer Island Code’s
12 development code resulting in substantial error and a decision unsupported by the evidence in the
13 record. **First**, the Gross Floor Area is much larger than permitted, resulting in a home that is
14 substantially larger than allowed. This erroneous calculation was based on a similarly erroneous
15 calculation of existing and finished grade of the home. **Second**, the required side yard depth is less
16 than the 10 feet required on the east side of the proposed home. **Third**, the rooftop railings as part
17 of the downhill facade extend above code height limits. **Fourth**, the proposed retaining
18 walls/rockeries exceed code height limits. The City has provided no explanation for why the
19 Applicant is exempt from or able to evade applicable building and development regulations that
20 should constrain the project’s gross floor area, require a larger side yard, limit the maximum height
21 of certain features, and limit the heights of multiple retaining walls/rockeries.

22 VI. ASSIGNMENTS OF ERROR

23 1. The City relied on an incomplete record and erroneously approved the “existing 24 grade” and “finished grade” calculations in the Final Plan Set skewing several key 25 metrics in the plan set

26 As a threshold issue, critical calculations including building height and building elevation,
gross floor area, and side yard depth rely on a proper underlying calculation of existing or finished

1 grade. If these calculations are off, so are the resulting height and size of the home. Here, there are
2 two principle errors that plague the Applicant’s proposal and the City’s approval of it related to
3 existing and finished grade, resulting in various erroneous calculations: (a) the “existing grade” is
4 distorted because the determination relies on an incomplete record and fails to apply the applicable
5 administrative interpretations; and (b) the “finished grade” is distorted because it is based on an
6 incorrect calculation.

7 **As to existing grade**, the record lacks important information required for a determination
8 of “existing grade.” The topographic survey map should show the grade beneath the structure, but
9 currently it ignores the grade of the existing home entirely (beyond spot elevations at its entrances).
10 Specifically, the record does not establish the grade underlying the existing structure, which is
11 required by Development Services Group (DSG)² Administrative Interpretation 12-004 and
12 Administrative Interpretation 04-04.

13 “Existing grade” is defined as the surface level at any point on the lot prior to alteration³
14 of the ground surface, or “the grade prior to any development.” MICC 19.16.010.E.; Exhibit E
15 (Administrative Interpretations 12-004 and 04-04). In some cases, a survey of conditions prior to
16 the existing development may be available as evidence of the “existing grade.” *Id.* However, if
17 there is no concrete evidence or verification from a previous survey document that identifies
18 existing grade, the existing grade underlying the existing structure is used as the elevation for the
19 proposed development. Administrative Interpretations 04-04 and 12-004.

20 Here, the City and its expert, Mr. James Harper, determined that no survey of the site’s
21 pre-development conditions exists.⁴ The Hearing Examiner in an appeal of a related permit
22 determined the same.⁵ Therefore, the existing grade underlying the structure should control. The

23 ² Now referred to as the City of Mercer Island, Department of Community Planning & Development.

24 ³ MICC 19.16.010.A. defines “alteration” as “any human-induced action which adversely impacts the existing
25 condition of the area, including grading, filling, dredging, draining, channeling and paving (including construction
26 and application of gravel).”

⁴ See Exhibit G, Report of James Harper, Senior Associate Bush Roed & Hitchings, Inc., to the City dated August
14, 2023)

⁵ See Exhibit H, APL23-009, Order of Summary Dismissal of Appeal of Critical Area Review 2 (Ref. file no. CAO23-
011) issued December 2, 2023 at 6 (“No ancient survey has been presented to show what the terrain on 6950 was

1 existing structure is built with slabs directly on dirt. *See* Exhibit F (Construction Photos).
2 Therefore, the elevation of “existing grade underlying the existing structure” is the elevation of
3 that dirt underneath the existing structure. *See* Administrative Interpretation 12-004. Despite this,
4 the City has permitted the Applicant to interpolate the grades within the footprint of the existing
5 structure, contrary to the Administrative Interpretations and its own previous determinations. The
6 City’s expert, Mr. Harper, specifically stated that: the existing surveys⁶ “do not serve as a
7 “snapshot” of original grade conditions and cannot be relied on for interpolation or other such
8 formulaic determinations of *any past original grade.*” Exhibit G at 1 (emphasis in original).
9 Evidence in the record shows that the existing grade underlying the northeast portion of the
10 structure is 3 feet to 7 feet lower than the existing grade shown in the plans. This evidence includes
11 photographic evidence of the existing structure (both when it was under construction, and as it
12 exists today), and the elevation measured by the Applicant’s at the northwest entrance to the
13 existing structure. Exhibit D (Final Plan Set); Exhibit F (Construction Photos). For example,
14 photographic evidence comparing grades west of existing house during its 1950s construction
15 show the entire site has been significantly altered over time, both in the yard and underneath the
16 existing structure. *See* Exhibit F (Construction Photos).

17 Use of the higher than permitted existing grade improperly increases several metrics,
18 including the wall segment coverage and basement exclusion area, both of which are used in
19 calculating the gross floor area to determine the resulting size of the home. It also skews the
20 “average building elevation” calculation.⁷ Because the midpoint of the proposed house’s eastern
21 wall lies within the existing house, its elevation is the elevation of the grade underlying the existing
22 structure at that point. The elevation of this midpoint should also be determined per Administrative
23 Interpretation 04-04 in order to correctly compute “average building elevation” and “maximum

24 before any development occurred on the lot. (The lack of any such ancient survey is not unexpected given that the lot
25 was developed before the City was incorporated.) The code interpretation controls: The existing grade is the grade to
be used. Issue 2 must be dismissed based upon application of applicable law to the undisputed facts.”).

26 ⁶ Exhibit G at 1. Harper refers to a 2022, 1989 and 2005 survey of the property.

⁷ In the R-8.4 zone (where the site is located), “average building elevation” is calculated using the lower of “existing grade” or “finished grade” at the midpoint of each exterior wall segment. MICC 19.16.010.

building height” under the code. MICC 19.02.020(E)(1). The City’s approval of the existing grade in the Final Plan Set was in substantial error and unsupported by the evidence in the record. This error caused significant and blatant code errors in the resulting proposed home.

As to finished grade, the “finished grade” for the western basement wall was incorrectly determined. The Final Plan Set shows that that the wall segment coverage for the western basement wall is 59.37 percent. Exhibit D, Sheet A1.0. But, the wall segment coverage is more approximately 40 percent based upon manual inspection of Exhibit D, Sheet A3.1. Therefore, the wall segment coverage of the western basement wall is lower than stated in the Final Plan Set and Permit 2207-019. Use of higher-than-permitted wall segment coverage improperly increases the basement exclusion area (used to calculate the gross floor area) for the proposed house. Figure 1 and 2 below are derived from the Final Plan Set and include overlays prepared by Mr. Grove that depict the errors described above:

Figure 1: Final Plan Set with Existing and Finished Grade Error Overlay

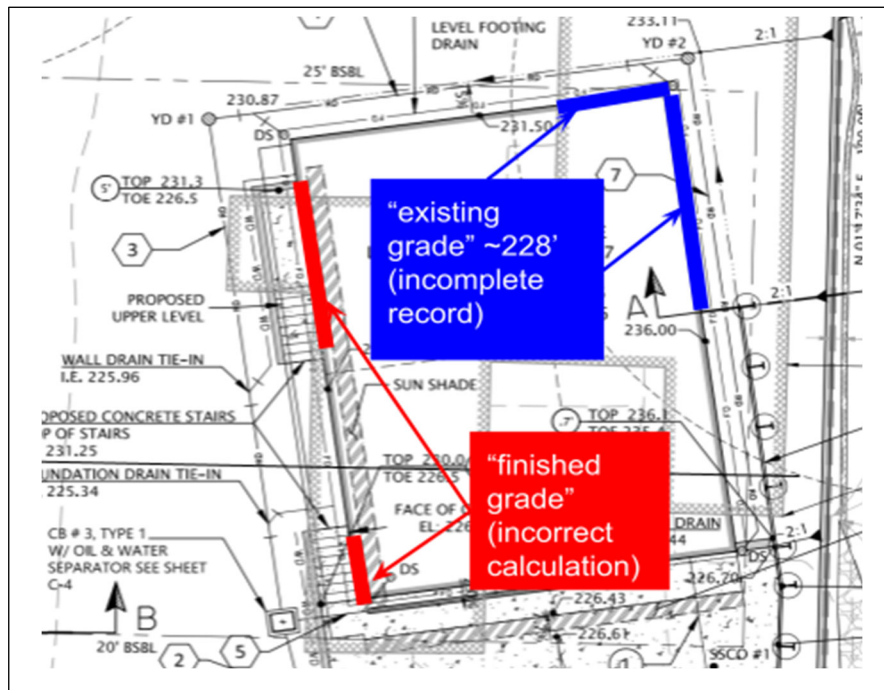
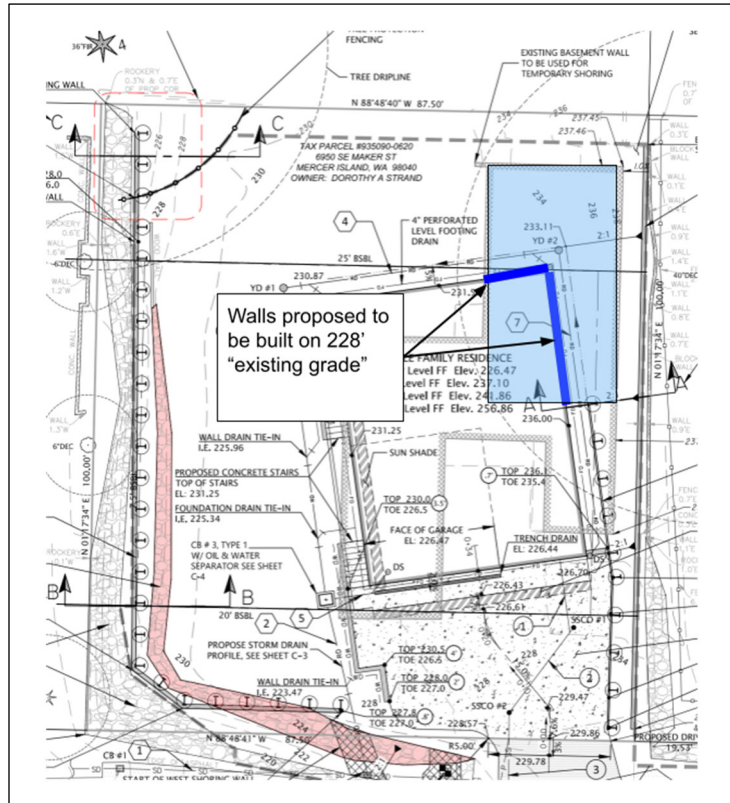

Figure 2: Final Plan Set with Existing Grade Overlay



2. The City substantially erred in approving a Gross Floor Area larger than permitted and a home substantially larger than the code allows.

Incorrect determinations of both “existing grade” and “finished grade” have resulted in a larger Gross Floor Area than permitted. In other words, the Applicant has improperly been approved to build a larger house than is permitted.

Gross Floor Area (“GFA”) is defined as “the total square footage of floor area bounded by the exterior faces of the building.” MICC 19.16.010.G. GFA is important because it essentially sets out the limits of the size of the home in relation to the size of the lot. A correct GFA calculation relies on a correct calculation of “existing grade” and “finished grade.” See MICC Title 19, Appendix B. This is because a portion of the basement floor area (called the basement exclusion area, which is used as part of the GFA calculation) can be excluded by the developer depending on which is lower—the existing or finished grade. *Id.*

1 The incorrect existing and finished grade calculations resulted in a smaller basement floor
2 exclusion area than is used in the Final Plan Set. The Final Plan Set calculates a basement floor
3 exclusion area of 937.5 square feet. Exhibit D at A1.0. The actual basement exclusion area to be
4 used is closer to 613 square feet. This results in a GFA for the proposed house that is approximately
5 4,250 square feet, which is significantly larger than the permitted 3,937.5 square feet. As it stands,
6 if not corrected, the City has permitted a house with a GFA that is roughly 300 to 350 square feet
7 larger than the 3,937.5 square feet permitted.

8 **3. The City substantially erred by misapplying the code allowing the structure to**
9 **encroach into the required side yard, resulting in a side yard smaller than required**
10 **by the code.**

11 In Mercer Island, single-family dwellings with a height of more than 25 feet measured from
12 the existing or finished grade, whichever is lower, to the top of the exterior wall facade adjoining
13 the side yard must provide a minimum side yard depth of **ten feet**. MICC 19.02.020.C.1.c.iii.b.
14 (emphasis added).⁸ This allows sufficient space between homes or structures and reduced
15 crowding. But, here, the side yard is only 7.5 feet. The City appears to have allowed this because
16 *part* of the façade adjoining the side yard is less than 25 feet while other portions are demonstrably
17 over 25 feet. *See* Exhibit D (Final Plan Set) at A1.0 and A3.1. Specifically, the relevant portion of
18 the façade is on average 28' in height while the highest point is 33.9' per the Final Plan Set. The
19 Applicant cannot cherry pick a shorter section to avoid this requirement.⁹ The City erroneously
20 approved this blatant code violation in the plans.

21 **Figure 3** below depicts the impact of a 7.5 foot versus 10 foot side yard on the surrounding
22 areas. Figure 3 is derived from the Final Plan Set with an overlay. This shows how much closer
23 Ms. Strand's proposed home will be to Mr. Grove's than it is otherwise allowed.

24 ⁸ Because there is a facade with a height of more than 25 feet adjoining the Applicant's east "side yard," MICC
25 19.02.020(C)(1)(c)(iii)(b) mandates that the required east "side yard" depth be 10 feet.

26 ⁹ The Applicant appears to have misunderstood this portion of the code as Sheet A1.0 contains a note pointing to the
east side of the proposed house as "10'-0" SETBACK ABOVE 15'." While the code actually states: "Single-family
dwellings with a height of more than 25 feet measured from the existing or finished grade, whichever is lower, to the
top of the exterior wall facade adjoining the side yard shall provide a minimum side yard depth of ten feet." MICC
19.02.020.C.1.c.iii.b. (emphasis added).

Figure 3: Comparison 7'5" proposed (yellow) and 10' (red) east side yard

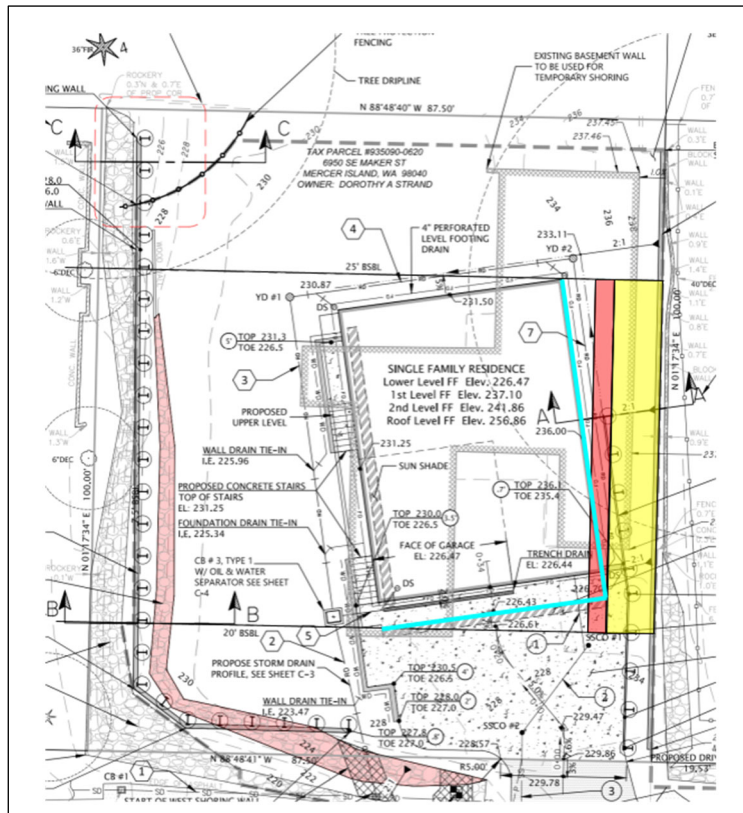

4. The City substantially erred in allowing the home’s rooftop railings on the southern side to exceed maximum height limits set by the code.

The City erroneously approved design plans that exceed the maximum building height limit by almost four feet when measured on the downhill side of the sloping lot. In most cases, maximum building height cannot exceed 30 feet above the average building elevation. MICC 19.02.020.E.1. For downhill sloping lots, like this one, the maximum building facade height also cannot exceed 30 feet in height. MICC 19.02.020.E.2. Building facade height, which includes the rooftop railings,¹⁰ is “measured from the existing grade or finished grade, whichever is lower, at the furthest downhill extent of the proposed building, to the top of the exterior wall facade.” *Id.* The height limit can be increased up to five feet for certain appurtenances like chimneys or solar panels. MICC 19.02.020.E.3. But, the code expressly excludes rooftop railings from that list of allowable

¹⁰ Per MICC 19.16.010.F, railing attached to exteriors walls are part of the façade.

1 appurtenances by stating “rooftop railings may not extend above the maximum allowed height for
2 the main structure.” MICC 19.02.020.E.3.b.

3 The property at issue in this case slopes downhill primarily from east to west. The rooftop
4 railings attached to the southern exterior wall and the southern end of the western wall both exceed
5 maximum allowed heights. Those railings may not extend more than 30’ above the lower of the
6 “finished grade” or “existing grade” at the furthest downhill extent of the proposed house. The
7 finished grade at the furthest downhill extent of the façade on the southern end of the house is
8 226.5’, the railings are at 260.4’, exceeding the maximum height allowed by at least 3.9 feet. The
9 City has provided no information regarding why these rooftop railings should be exempted from
10 existing regulations. Figure 4, below derived from Sheet A3.1 ___ of the Final Plan Set shows (in
11 black) the rooftop railings that extend above 256.5’ at the furthest downhill extent of the proposed
12 house.

13 **Figure 4: Distance from rooftop railing to finished grade**

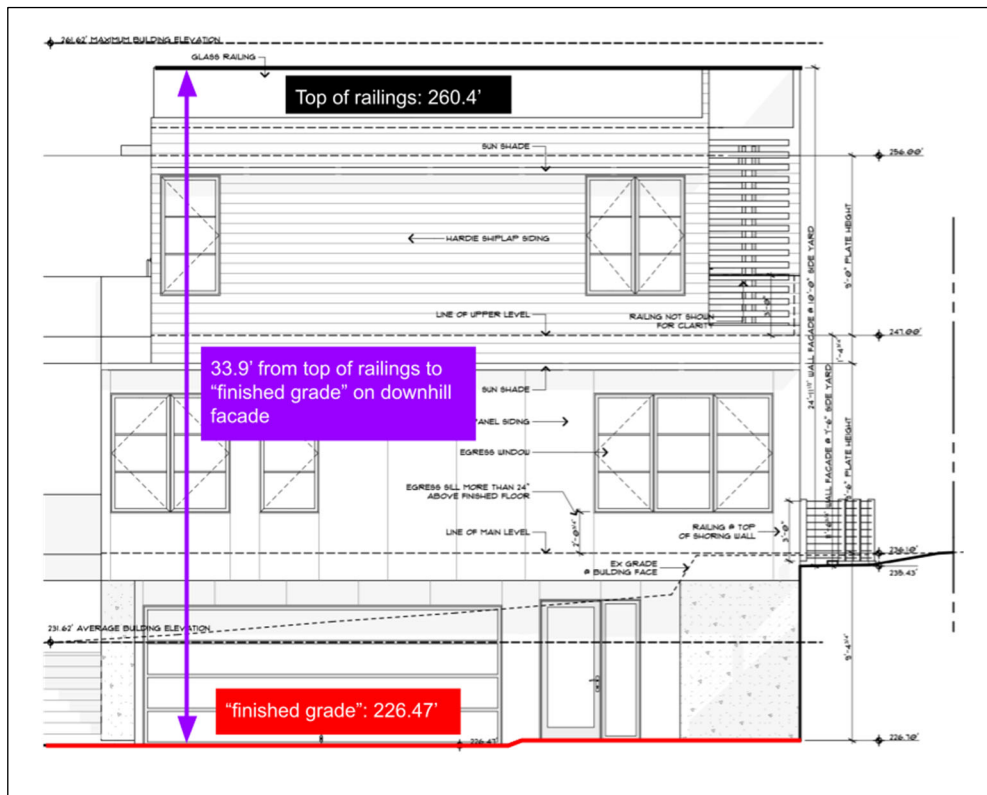

1 **5. The City substantially erred in allowing retaining walls/rockeries that do not**
2 **comply with the height requirements set by the code.**

3 The Mercer Island Code sets forth specific regulations related to the heigh of retaining
4 walls/rockeries that contain “fill slopes”¹¹ in required yards. MICC 19.02.050. “Retaining
5 walls/rockeries” are “walls of masonry, wood, rock, metal, or other similar materials or
6 combination of similar materials that bears against earth or other fill surface for purposes of
7 resisting lateral or other forces in contact with the wall, and/or the prevention of erosion.” MICC
8 19.16.010.R. For this site, the Hearing Examiner previously ruled in APL23-009 that the existing
9 rocks are “not a wall”, therefore not “retaining walls/rockeries” under the code. Exhibit H.

10 Any retaining walls/rockeries constructed as part of this proposal must conform with the
11 current code requirements. Exhibit D (Sheet SH2).¹² The retaining walls/rockeries in the front yard,
12 west yard and rear yards must comply with the height restriction of 72 inches per MICC
13 19.02.050.D.5.b., measured from the top of the retaining wall or rockery to the existing grade or
14 finished grade below it, whichever is lower. MICC 19.02.050.C.2. As previously determined, the
15 dirt beneath the western and southern property perimeter is the “existing grade.”¹³

16 **Table 1** below provides a comparison of required height limits to proposed “retaining
17 wall/rockery” heights derived from the existing and finished grades and proposed heights in the
18 Final Plan Set. As depicted below, the proposed heights greatly exceed the height limit set forth in
19 19.02.050.D.5.b.

20
21
22
23
24 ¹¹ See Exhibit H, APL23-009, Order of Summary Dismissal at 4, Hearing Examiner Galt determined that the
25 western side yard is a fill slope. (“The western fill slope has a total maximum height (from toe to top) of about 14.5
26 feet.”).

¹² Exhibit I at 1 (Revised Geotech Report). The Applicant describes the shoring as “the partial removal of the
existing western rockery, combined with the installation of closely-spaced soldier piles immediately behind the
remaining lower portion of the rockery.”

¹³ See Exhibit H, APL23-009, Order of Summary Dismissal at 6.

Table 1: Comparison code height limits versus retaining wall/rockery actual proposed height

Required Yard	“Existing Grade” at Bottom	“Finished Grade” at Top	Height Limit	Proposed Height
Front	214.4’	228’	72”	~160” (13.6’)
West Side	217.2’	228’	72”	~130” (10.8’)
Rear	219.6’	228’	72”	~100” (8.4’)

The City has provided no explanation for why this exceedance has been allowed to occur in light of the Hearing Examiner’s ruling in APL23-009, and it erred in approving a plan set that does so.

VII. CONCLUSION

Mr. Grove respectfully requests the Hearing Examiner remand Permit 2207-019 to the City for further consideration. Specifically:

- a) As to the existing and finished grade error, the Hearing Examiner should remand to the City to require (i) the Applicant to fully complete the record by demonstrating the grade underlying the existing house, (ii) correctly determine existing grade, and (iii) correctly determine finished grade;
- b) As to the gross floor area error, the Hearing Examiner should remand to the City to require the Applicant to correctly determine the basement exclusion area and the associated gross floor area;
- c) As to the required side yard errors, the Hearing Examiner should remand to the City to require the applicant to increase the depth of the east “required side yard” to the 10 feet required by the code;
- d) As to the rooftop railing errors, the Hearing Examiner should remand to the City to require the proposal be brought into compliance with existing height restrictions; and
- e) As to the retaining walls/rockeries errors, the Hearing Examiner should remand to the City to require the western and southern perimeter walls meet the height requirements set forth in the code.

1
2
3
4
5
6
7
8
9
10
11
12
13
14
15
16
17
18
19
20
21
22
23
24
25
26

Respectfully submitted: March 5, 2024

PERKINS COIE LLP

By: /s/Zachary E. Davison

Zachary E. Davison, WSBA No. 47873
ZDavison@perkinscoie.com
1201 Third Avenue, Suite 4900
Seattle, Washington 98101-3099
Telephone: +1.206.359.8000
Facsimile: +1.206.359.9000

Gabrielle Gurian, WSBA No. 55584
GGurian@perkinscoie.com
10885 N.E. Fourth Street, Suite 700
Bellevue, Washington 98004-5579
Telephone: +1.425.635.1400
Facsimile: +1.425.635.2400

Attorneys for Appellant Daniel Grove

13-

APPELLANT, DANIEL GROVE'S NOTICE OF APPEAL

Perkins Coie LLP
1201 Third Avenue, Suite 4900
Seattle, Washington 98101-3099
Phone: +1.206.359.8000
Fax: +1.206.359.9000

CERTIFICATE OF SERVICE

I hereby certify that I served the foregoing NOTICE OF APPEAL on the following:

City Clerk’s Office

9611 SE 36th Street
Mercer Island, WA 98040
Phone: (206) 275-7793
E-mail: cityclerk@mercerisland.gov

to be sent by the following indicated method or methods, on the date set forth below:

- by sending via the court’s electronic filing system
- by email
- by mail
- by hand delivery

DATED: March 5, 2024

PERKINS COIE LLP

By: s/ Zachary E. Davison
Zachary E. Davison, WSBA No. 47873
ZDavison@perkinscoie.com
1201 Third Avenue, Suite 4900
Seattle, Washington 98101-3099
Telephone: +1.206.359.8000
Facsimile: +1.206.359.9000

Gabrielle Gurian, WSBA No. 55584
GGurian@perkinscoie.com
10885 N.E. Fourth Street, Suite 700
Bellevue, Washington 98004-5579
Telephone: +1.425.635.1400
Facsimile: +1.425.635.2400

Attorneys for Appellant Daniel Grove

EXHIBIT A



Weekly Permit Bulletin
9611 SE 36th Street | Mercer Island, WA 98040 | 206.275.7605

*****City Hall Closed – [Learn More](#) About Long-Range Facility Planning*****

February 20, 2024

Providing official notice of land use applications, meetings, decisions, recommendations, hearings, and appeals of land use decisions within the City of Mercer Island.

How to use this bulletin

To learn more about a project:

- Click the “Project Documents” link to view digital documentation. The project documents available through this link contain most, but may not contain all, publicly available information. For example, when a project is updated with a different project design, older designs may be removed from the public folder to avoid confusion. Each folder will be updated when there is a project revision.
- Call the project planner to arrange to review the project files. The planner’s contact information is in the notice. You may also call the “Planner Helpline” for zoning related questions at 206-275-7729. Additional resources are available online:
 - <http://www.mercerisland.gov>: Staff directory, city regulations, and additional information about permits.
 - <http://www.mybuildingpermit.com>: Follow the status of a specific permit by address or permit number.
 - [Mercer Island Map Portal](#): A tool to search for site-specific information.

To comment on a project:

If comments are provided within the specified comment period, they will be forwarded to the appropriate reviewer, and you will become a party of record. Written comments can specifically address how the proposed work does not meet one or more of the criteria listed in the Applicable Development Regulations.

- Send your comments in writing to the project planner identified in the notice. Be sure to include your name, address, and email if applicable.
- The City will accept public comments at any time prior to the closing of the record of an open record predecision hearing, if any, or if no open record predecision hearing is provided, prior to the decision on the project land use review.
- If you submit a written comment, staff will send you a copy of the notice of decision or recommendation.

Will there be a public hearing on this application?

Public Hearings are only required for Type 4 permits. For a list of Type 4 (IV) permits, please refer to [Mercer Island City Code 19.15.030](#) Table A. The project will state under the Public Hearing section if a hearing is required.

What is SEPA?

State Environmental Policy Act (SEPA) is a review intended to act as a “safety net” in protecting the environment. Following SEPA review, the City must issue a determination of Significance, Non-Significance, or a Mitigated Determination of Non Significance. Applicants for a SEPA review must complete a SEPA [checklist](#), and may need to prepare additional mitigation to avoid a “probable significant impact” to the environment.

When is a project SEPA exempt?

The state Department of Ecology establishes categorical exemptions to SEPA review, which are generally described here: [WAC 197-11-800](#). For example, a shoreline dock may be SEPA exempt if the dock was legally established, and normal maintenance and repair is proposed. However, SEPA is required if the dock will expand or if a new dock is built.

Where can I find more information?

Please review the Washington State Department of Ecology SEPA [website](#) and the SEPA [handbook](#). Another useful page is the SEPA form templates found [here](#).

Receive the bulletin by email.

Email the Deputy City Clerk at deb.estrada@mercerisland.gov to receive or unsubscribe from the weekly bulletin distribution list.

How to reach us.

9611 SE 36th Street | Mercer Island, WA 98040 | (206) 275-7729 | The Community Planning & Development Department is located on the lobby floor of Mercer Island City Hall.

How to search permit records online.

Land use review actions that are not listed in this bulletin can be searched online at <https://permitsearch.mybuildingpermit.com/>. Searching online permit records requires the following steps:

1. Select “Mercer Island” from the jurisdiction dropdown menu.
2. In the blue “Search by” section, click the “Project Info” tab.
3. The “Project Name/Description” field is optional. It can be left blank unless searching for a specific project.
4. Select the permit type from the “Permit Type” dropdown menu.
5. Use the “Permit Status” field to narrow searches by status. This field is optional. “Permit Status” can be left blank unless searching for a specific project.
6. Use the “Date Type” to limit your search to permits either applied, issued, or finalized. Use the “Applied” option to search for permits that are still in review. Use the “Issued” option to see permits that have been issued; these permits were approved. The “Finalized” option will show permits that received a final inspection and approval (Note: not all permits are finalized, only those requiring a final inspection will be finalized).
7. Use the “From” and “To” fields to define the dates you want to search between.
8. After the search is conducted, results will display below the search fields. You have the option of downloading the records to an Excel spreadsheet.

Notices of Applications

NONE

Notices of Decision

Notice of Decision: File No. 2207-019

NOTICE IS HEREBY GIVEN that approval has been granted for the application described below:

File No.:	2207-019
Permit Type:	Type III
Description:	Approval for a building permit for the demolition of the existing single-family residence and construction of a new, 3,936 square foot single-family residence with an Accessory Dwelling Unit.
Applicant/Owner:	Jeffrey Almeter / Dorothy Strand
Location of Property:	6950 SE Maker St, Mercer Island WA 98040 King County Assessor tax parcel number: 9350900620
Applicable Development Regulations:	Building permits are reviewed for compliance with: <ul style="list-style-type: none">• Title 15 – Water, Sewers, and Public Utilities• Title 17 – Construction Codes• Title 19 – Unified Land Development Code
Project Documents:	https://mieplan.mercergov.org/public/2207-019
Decision:	Approved subject to conditions.
Property Tax Revaluation:	Affected property owners may request a change in valuation for property tax proposed notwithstanding any program of revaluation. For more information, contact the King County Assessor's office at (206) 296-7300 or visit the King County website .
Application Process Information:	Date of Complete Application: July 6, 2022 Public Comment Period: September 6, 2022 through October 6, 2022 Date Notice of Decision Issued: February 20, 2024 Appeal Filing Deadline: 5:00 PM on Tuesday, March 5, 2024 *
	* Please refer to MICC 19.15.130 and MICC 17.14.020 for the City's appeal code
Project Contact:	Molly McGuire, Planner molly.mcguire@mercerisland.gov (206) 275-7712

Notice of Decision: File No. SUB23-001 & SEP23-001

NOTICE IS HEREBY GIVEN that approval has been granted for the application described below:

File No.: SUB23-001 & SEP23-001

Permit Type: Type III

Description of Request: A request for preliminary short subdivision approval with SEPA review to divide the parent parcel into four (4) single-family residential lots.

Applicant/ Owner: Garrett Goudy (Navix Engineering Inc.) / Saintfield2 LLC

Location of Property: 7414 78th Ave SE, Mercer Island WA 98040

Property: Identified by King County Assessor tax parcel number: 2524049075

SEPA Compliance: On February 20, 2024, a mitigated determination of nonsignificance (MDNS) was issued for the proposed development, concurrently with this Notice of Decision, as reviewed under application number SEP23-001.

Applicable Development Regulations: Pursuant to Mercer Island City Code (MICC) [19.15.030](#) Table A, applications for Preliminary Short Subdivisions are required to be processed as Type III land use reviews. Processing requirements for Type III land use reviews are further detailed in MICC 19.15.030 Table B.

Project Documents: <https://mieplan.mercergov.org/public/SUB23-001>

Decision: Approved subject to conditions.

Appeal Rights: *DISCLAIMER: This information is provided as a courtesy. It is the ultimate responsibility of the appellant to comply with all legal requirements for the filing of an appeal.*

Parties of record have the right to appeal certain permit and land use decisions. In some cases, other affected parties also have appeal rights. Depending on the type of decision, the appeal may be heard by a City Hearing Examiner, Commission, Board, or City Council, or outside the City to the State Shoreline Hearings Board, the State Growth Management Hearings Board, or King County Superior Court. For a comprehensive list of actions and the applicable entity who will hear the appeal, see MICC 19.15.030 Table B.

If you desire to file an appeal of a decision that is appealable to the City, you must submit the appropriate form and file it with the City Clerk **within the time stated in the Notice of Decision.** Forms are available from Community Development and Planning. Upon receipt of a timely complete [appeal application](#) and [appeal fee](#), an appeal hearing will be scheduled. To reverse, modify or remand a decision, the appeal hearing body must find that there has been substantial error; the proceedings were materially affected by irregularities in procedure; the decision was unsupported by material and substantial evidence in view of the entire record; or the decision is in conflict with the City's applicable decision criteria.

Application Process Information:	Date of Application:	January 9, 2023
	Determined to Be Complete:	January 24, 2023
	Public Comment Period:	January 30, 2023 through 5:00 PM on March 1, 2023
	Date Notice of Decision Issued:	February 20, 2024
	Appeal Filing Deadline:	5:00 PM on March 5, 2024

Project Contact: Molly McGuire, Planner
molly.mcguire@mercerisland.gov | (206) 275-7712

Notice of Mitigated Determination of Non-Significance (MDNS)

Notice of Mitigated Determination of Non-Significance File No. SEP23-001 (SUB23-001)

NOTICE IS HEREBY GIVEN for the application described below:

Application SEP23-001 (SUB23-001)

Numbers:

Description of proposal: State Environmental Policy Act (SEPA) review for a Preliminary Short Subdivision, SUB23-001, to divide the subject property into four lots. The subject property has an area of 68,827 square feet (1.58 acres) and the resulting lots will have areas of 16,254 square feet (Lot 1), 12,959 square feet (Lot 2), 12,498 square feet (Lot 3), and 12,647 square feet (Lot 4). All lots will be accessed from 78th Avenue SE via a new shared access tract along the north side of the subject property. The subject property is zoned Single-Family Residential (zoned R-9.6). Adjacent properties are within the R-9.6 zone and the adjacent properties contain residential uses.

Proponent: Garrett Goudy (Navix Engineering, Inc.) / Saintfiled2 LLC

Location of proposal: 7414 78th Avenue SE, Mercer Island, WA 98040; King County Assessor Tax Parcel Number: 2524049075.

Lead agency: City of Mercer Island

Based on review of the proposal and applicable Mercer Island City Code (MICC) sections, the lead agency for this proposal has determined that the proposal does not have a probable significant adverse impact on the environment that is not addressed by the aforementioned code sections. An environmental impact statement (EIS) is not required under RCW 43.21C.030(2)(c). This decision was made after reviewing a completed environmental checklist. This information is available to the public on request. Please follow this file path to access the associated documents for this project: <https://mieplan.mercergov.org/public/SEP23-001>.

_____ There is no comment period for this DNS.

X

_____ This MDNS is issued after using the optional DNS process in WAC 197-11-355. There is no further comment period on the DNS.

_____ This DNS is issued under WAC 197-11-340(2); the lead agency will not act on this proposal for 14 days from the date below.

Responsible Official: Ryan Harriman, EMPA, AICP – Planning Manager
9611 SE 36th Street | Mercer Island, WA 98040
Email: ryan.harriman@mercerisland.gov

Date: February 20, 2024

Signature: *Ryan Harriman*

Findings:

1. The City received a comment letter from the Washington State Department of Ecology (“Ecology”), dated March 1, 2023. The comment letter outlines what to do if an underground storage tank (“UST”) is discovered on the subject property, what to do to ensure that the environment is protected during any fueling or hazardous substance handling activities to prevent any potential releases to the environment, and how to manage environmental impacts from the Tacoma Smelter Plume.

Mitigation Measures

The following mitigation measures are required pursuant to the Ecology Comment Letter, dated March 1, 2023, and pursuant to RCW 43.21C.060 and WAC 197-11-350 to mitigate probable and unavoidable impacts identified for this proposal:

1. The King County database shows the house was built in 1952 and that the heating source is oil which indicates the possible presence of an underground storage tank (UST). If a UST is encountered during demolition activities, it must be decommissioned in accordance with local fire department regulations. In addition, if soil or groundwater contamination is encountered during UST decommissioning, the contamination must be reported, characterized, and cleaned up in accordance with the Washington State Department of Ecology regulations (WAC 173-340). Ecology strongly recommends working with an environmental professional to assist with UST decommissioning and regulatory compliance requirements.
2. The contractor shall ensure that the environment is protected during any fueling or hazardous substance handling activities to prevent any potential releases to the environment. If a release occurs, it should be reported to the Washington State Department of Ecology (<https://ecology.wa.gov/Footer/Report-an-environmental-issue>).
3. The proposed development is located in an area that may have been contaminated with heavy metals due to the air emissions originating from the old Asarco smelter in north Tacoma (visit Ecology’s Tacoma Smelter Plume map search tool: <https://apps.wa.gov/ecy/dirtalert/>). Soil contamination from the former Asarco smelter poses a risk to human health and the environment. Children are at especially high risk from direct exposure to contaminated soil. Construction workers, landscapers, gardeners, and others who work in the soils are also at risk.

The following are conditions of approval that shall be completed prior to the issuance of any site development permits or the initiation of grading, filling, or clearing on the subject property:

- a. Sample the soil and analyze for arsenic and lead following the [2019 Tacoma Smelter Plume Guidance](#). The soil sampling results shall be sent to Ecology for review.
- b. If lead or arsenic are found at concentrations above the Model Toxics Control Act (MTCA) cleanup levels (Chapter 173-340 WAC); the owners, potential buyers, construction workers, and others shall be notified of their occurrence. The MTCA cleanup level for arsenic is 20 parts per million (ppm) and lead is 250 ppm.
- c. If lead, arsenic and/or other contaminants are found at concentrations above MTCA cleanup levels, the applicant shall:
 - i. Develop soil remediation plan and enter into the Voluntary Cleanup Program with Ecology. For more information on the Voluntary Cleanup Program, visit Ecology website at: <https://ecology.wa.gov/Spills-Cleanup/Contamination-cleanup/Cleanup-process/Cleanup-options/Voluntary-cleanup-program>.

- ii. Obtain an opinion letter from Ecology stating that the proposed soil remediation plan will likely result in no further action under MTCA. The applicant shall provide to the local permitting agency the opinion letter from Ecology.
- iii. Prior to finalizing site development permits, provide to the local land use permitting agency “No Further Action” determination from Ecology indicating that the remediation plans were successfully implemented under MTCA.
- d. If soils are found to be contaminated with arsenic, lead, or other contaminants, extra precautions shall be taken to avoid escaping dust, soil erosion, and water pollution during grading and site construction. Contaminated soils generated during site construction shall be managed and disposed of in accordance with state and local regulations, including the Solid Waste Handling Standards regulation (Chapter 173-350 WAC). For information about soil disposal contact the local health department in the jurisdiction where soils will be placed.

The link below provides a fact sheet that explains more how the arsenic and lead clean-up levels were set and why Ecology sees that they are protective for human health: <https://fortress.wa.gov/ecy/publications/SummaryPages/1109095.html>.

For assistance and information about Tacoma Smelter Plume and soils contamination, contact Eva Barber with the Toxic Cleanup Program at (360) 999-9593 or at eva.barber@ecy.wa.gov

Appeal Information

This decision to issue a Mitigated Determination of Non-significance (MDNS) rather than to require an EIS may be appealed pursuant to MICC 19.15.130, Appeals; and Chapter 19.21 MICC, Environmental procedures.

Any party of record may appeal this determination to the City Clerk at 9611 SE 36th Street Mercer Island, WA 98040 no later than 5:00 PM on Monday, March 5, 2024, by filing a timely and complete appeal application and paying the appeal fee. You should be prepared to make specific factual objections. Contact the City Clerk to read or ask about the procedures for SEPA appeals. To reverse, modify, or remand this decision, the appeal hearing body must find that there has been substantial error, the proceedings were materially affected by irregularities in procedure, the decision was unsupported by material and substantial evidence in view of the entire record, or the decision is in conflict with the city’s applicable decision criteria.

Notices of Lot Line Revision

File Nos.:	SUB24-001
Description of Request:	An application for a Lot Line Revision to consolidate 2 lots.
Applicant:	Mark X. Plog (Plog Engineering, PLLC)
Location of Property:	6236 SE 22 nd St, Mercer Island, WA 98040; King County Assessor tax parcel numbers: 5442300796 & 5442300765
Public Documents:	https://mieplan.mercergov.org/public/SUB24-001/
Complete Application Date:	February 13, 2024
Assigned Staff:	Grace Manahan, Assistant Planner grace.manahan@mercerisland.gov (206) 275-7764

Accessory Dwelling Unit Permit Applications

NONE

Notices of Public Hearings

NONE

Notices of Threshold Determination

NONE

Notices of Type II Permit

NONE

Seasonal Development Limitation Applications

NONE

Wireless Communication Facility Applications

NONE

EXHIBIT B

CITY OF MERCER ISLAND

COMMUNITY PLANNING & DEVELOPMENT

9611 SE 36TH STREET | MERCER ISLAND, WA 98040

PHONE: 206.275.7605 | www.mercerisland.gov

Inspection Requests: Online: www.mybuildingpermit.com VM: 206.275.7730



PERMIT APPLICATION

A P P L I C A N T	SITE ADDRESS* 6950 SE MAKER ST		PROJECT VALUATION (REQUIRED)* 1,190,563		PERMIT #	
	PROPERTY OWNER: * DOROTHY STRAND TENANT NAME: N/A		ADDRESS* 6950 SE MAKER ST, MERCER ISLAND		PHONE 425.802.1455 E-MAIL* kcra2005@yahoo.com	
	APPLICANT CONTACT NAME* JEFFREY ALMETER		ADDRESS 9506 13TH AVE NW, SEATTLE, WA, 98117		PHONE 303.903.1783 E-MAIL* jeffrey.almeter@gmail.com	
	ARCHITECT / DESIGNER (Company/Name) SAME AS APPLICANT		ADDRESS		PHONE E-MAIL*	
	STRUCTURAL ENGINEER (Company/Name) DON SHIN		ADDRESS 3121 147TH PLACE SE, MILL CREEK, WA 98012		PHONE 425.338.4776 E-MAIL* dshin@engineer.com	
	CONTRACTOR(Company/Name) TBD		ADDRESS		PHONE E-MAIL*	
	STATE CONTRACTOR LICENSE #*: ELECTRICAL CONTRACTOR (Company/Name) TBD		ADDRESS		MI BUSINESS LICENSE #*: PHONE E-MAIL*	
	STATE CONTRACTOR LICENSE #*: PLUMBING CONTRACTOR (Company/Name) TBD		ADDRESS		MI BUSINESS LICENSE #*: PHONE E-MAIL*	
	STATE CONTRACTOR LICENSE #*: <i>*Required</i>		MI BUSINESS LICENSE #*:			
	PERMIT TYPE	<input checked="" type="checkbox"/> Building <input type="checkbox"/> Demolition <input type="checkbox"/> Electrical <input type="checkbox"/> Fire Protection <input type="checkbox"/> Fuel Tank <input type="checkbox"/> Grading	<input type="checkbox"/> Low Voltage <input type="checkbox"/> Mechanical <input type="checkbox"/> Plumbing <input type="checkbox"/> Stormwater <input type="checkbox"/> Site Development	OCCUPANCY TYPE	<input checked="" type="checkbox"/> SINGLE FAMILY <input type="checkbox"/> MULTI FAMILY <input type="checkbox"/> COMMERCIAL <input type="checkbox"/> MIXED USE <input type="checkbox"/> CHRUCH/SCHOOL	WORK TYPE
Briefly Describe Proposed Scope of Work (REQUIRED): DEMOLITION OF EXISTING SINGLE FAMILY RESIDENCE, NEW SINGLE FAMILY RESIDENCE						
Will your project result in (all questions must be answered):						
A change of use				YES <input type="checkbox"/>	NO <input checked="" type="checkbox"/>	
New Single Family dwelling				YES <input checked="" type="checkbox"/>	NO <input type="checkbox"/>	
A reduction in any existing side yard setback				YES <input type="checkbox"/>	NO <input checked="" type="checkbox"/>	
An increase in lot coverage by more than 100 square feet				YES <input type="checkbox"/>	NO <input checked="" type="checkbox"/>	
An increase in the gross floor area of more than 500 square feet				YES <input checked="" type="checkbox"/>	NO <input type="checkbox"/>	
An increase in the maximum building height above the highest point of the building				YES <input checked="" type="checkbox"/>	NO <input type="checkbox"/>	

Continued on next page

NOTICE TO APPLICANT

Applications for which no permit is issued within 18 months shall expire. Once issued, building permits shall expire if work is not completed within two years from date of issue. Electrical, mechanical, and plumbing permits shall expire at the same time as the associated building permit except that if no associated building permit is issued, the electrical, mechanical and/or plumbing permit shall expire 180 days from issuance.

All work shall be done in accordance with the approved plans, except where such approval is in conflict with other codes. The approved plans shall not be changed or modified without the prior approval of the Building Official. It is the responsibility of the permittee to obtain the required inspections. Failure to notify this department that work is ready for inspection may necessitate the removal of some of the construction materials at the owner's expense in order to perform such inspections. All provisions of laws and ordinances governing this type of work will be met whether specified herein or not. The granting of a permit does not presume to give authority to violate or cancel the provisions of any other state or local law regulating construction of the performance of construction.

I hereby certify that I am the owner of the subject property or I have been authorized by the owner(s) of the subject property to represent this application, and that I have read and examined this application and know the same to be true and correct. Also, I have received authorization to utilize all contractor license information provided within this application and have been informed about contractor license laws (RCW 18.27, RCW 18.106, etc.), and the potential risks and monetary liability to the homeowner for using an unregistered contractors (general, plumbing, electrical, etc.). Further information can be obtained at 1-800-647-0982.

Jeffrey Almeter Digitally signed by Jeffrey Almeter
Date: 2022.07.05 01:58:59 -07'00'

4 JULY 2022

JEFFREY ALMETER

Signature of Owner/Contractor/Authorized Agent

DATE

Printed Name of Owner/Contractor/Authorized Agent

CITY OF MERCER ISLAND

COMMUNITY PLANNING & DEVELOPMENT

9611 SE 36TH STREET | MERCER ISLAND, WA 98040

PHONE: 206.275.7605 | www.mercergov.org

Inspection Requests: Online: www.mybuildingpermit.com VM: 206.275.7730



SITE DEVELOPMENT INFORMATION

Worksheet for single family residential development

PROJECT INFORMATION

Permit Number: _____ Parcel Number: _____
Site Address: _____ Phone Number: _____
Owner Name: _____ Date: _____
Signature & phone number of Individual who completed this worksheet: _____

Signature

Phone Number

GENERAL INFORMATION

Will any large trees be removed as a result of this development activity? Yes No

Large tree- trees with diameter of greater than or equal to 10 inches.

Do you have an Accessory Dwelling Unit? New ADU Existing ADU No

Will you be adding air conditioning to the proposed development? Yes No

What is the total square footage of all proposed decks
(covered and uncovered) on the property? _____ Square Feet

This is a worksheet and is not a substitute for the Mercer Island Development Regulations. Please consult the Mercer Island City Code. The City may require additional information to be supplied to document compliance with regulations.

LOT SLOPE

According to the Mercer Island City Code, slope is a measurement of the average incline of the lot or other piece of land calculated by subtracting the lowest elevation of the property from the highest elevation and dividing the resulting number by the shortest horizontal distance between these two points. The resulting product is multiplied by 100.

LOT SLOPE CALCULATIONS

Highest Elevation Point of Lot: _____ Feet
Lowest Elevation Point of Lot: _____ Feet
Elevation Difference: _____ Feet
Horizontal Distance Between High and Low Points: _____ Feet
Lot Slope* _____ %

**Lot slope is the elevation difference divided by horizontal distance multiplied by 100.*

Lot slope calculations shown on Sheet # _____

LOT COVERAGE

For single family residential development, “lot coverage” is the area of a lot that may be covered by a combination of the buildings and vehicular driving surfaces. Lot coverage is based on “net lot area”. Net lot area is the size of the lot minus the area within any access easements on the property that do not provide access to the home on the subject lot. The maximum lot coverage for a specific lot is based upon the lots slope (see above). The area of the lot that cannot be used for lot coverage is “required landscaping area”; the landscaping area is typically improved with either hardscape (see below) or softscape.

Please note: Lot coverage is not the same as impervious surface calculations used for drainage review.

Lot Slope	Maximum Lot Coverage (House, driving surfaces, and accessory buildings)	Required Landscaping Area
Less than 15%	40%	60%
15% to less than 30%	35%	65%
30% to 50%	30%	70%
Greater than 50% slope	20%	80%

ADJUSTMENTS

A one-time reduction in the required landscaping area and an increase in the allowed maximum lot coverage is allowed if:

- A. The total reduction in required landscaping area shall not exceed 5%, and the total increase in maximum lot coverage shall not exceed 5%; and
- B. The reduction in required landscaping area is associated with:
 - 1. A development proposal that will result in a single-story dwelling with wheelchair accessible entry, and may also include a single-story accessory building; or
 - 2. A development proposal on a flag lot that, after optimizing driveway routing and minimizing driveway width, requires a driveway that is more than the 25% of the allowed lot coverage. The allowed reduction in the required landscaping area and increase in the maximum lot coverage shall not exceed 5% or the area of the driveway in excess of 25% of the lot coverage, whichever is less. For example, a development proposal with a driveway that occupies 27% of the allowed lot coverage, may increase the total lot coverage by 2%
- C. A recorded notice on title, covenant, easement, or other documentation in a form approved by the city, shall be required. The notice on title or other documentation shall describe the basis for the reduced landscaping area an increase in lot coverage.

Does this project include a proposed adjustment? Yes No

LOT COVERAGE CALCULATIONS

- A. Gross Lot Area _____ Square Feet
- B. Net Lot Area _____ Square Feet
- C. Allowed Lot Coverage Area _____ Square Feet
- D. Allowed Lot Coverage _____ % of Lot
- E. Existing Lot Coverage:
 - 1. Main Structure Roof Area _____ Square Feet
 - 2. Accessory Building Roof Area _____ Square Feet
 - 3. Vehicular Use (driveway, paved access easements [portion used by the lot for access], parking _____ Square Feet
 - 4. Covered Patios and Covered Decks _____ Square Feet

5. Total Existing Lot Coverage Area (E1+E2+E3+E4)	_____	Square Feet
F. (Total Lot Coverage Area Removed)	_____	Square Feet
G. Proposed Adjustment for Single Story (Area)	_____	Square Feet
H. Proposed Adjustment for Flag Lot	_____	Square Feet
I. Total New Lot Coverage Area:		
1. Main Structure Roof Area	_____	Square Feet
2. Accessory Structure Roof Area	_____	Square Feet
3. Vehicular Use (driveway, paved access easement [portion used by the lot for access], parking)	_____	Square Feet
4. Covered Patios and Covered Decks	_____	Square Feet
5. Total New Lot Coverage Area (I1 + I2 + I3 + I4)	_____	
J. Total Project Lot Coverage Area = (E5 - F) + I5	_____	Square Feet
K. Proposed Lot Coverage Area = (J/B) x 100	_____	% of Lot

Lot coverage calculations shown on Plan Sheet # _____

HARDSCAPE

Up to 9% of the net lot area may consist of hardscape areas. For single family residential development, hardscape is the solid, hard, elements or structures that are incorporated into landscaping. The hardscape includes, but is not limited to, structures, paved areas, stairs, walkways, decks, patios, rockeries and retaining walls, and similar constructed elements that do not have a roof. The hardscape within the landscaping area consists of materials such as wood, stone, concrete, gravel, permeable pavements or pavers, and similar materials. Hardscape does not include solid, hard elements or structures that are covered by a minimum of two feet of soil intended for softscape (for example, a septic tank covered with at least two feet of soil and planted shrubs is not hardscape). The hardscape does not include driving surfaces or buildings.

In addition, unused lot coverage may also be improved with hardscape.

HARDSCAPE CALCULATIONS

A. Gross Lot Area	_____	Square Feet
B. Net Lot Area	_____	Square Feet
C. Area Borrowed from Lot Coverage	_____	Square Feet
D. Allowed Hardscape Area = 9% of lot area + C	_____	% of Lot
E. Allowed Hardscape Area	_____	Square Feet
F. Total Existing Hardscape Area:		
1. Uncovered Decks	_____	Square Feet
2. Uncovered Patios	_____	Square Feet
3. Walkways	_____	Square Feet
4. Stairs	_____	Square Feet
5. Rockeries and Retaining Walls	_____	Square Feet
6. Other _____	_____	Square Feet
7. Total Existing Hardscape Area (F1+F2+F3+F4+F5+F6)	_____	Square Feet
G. (Total Hardscape Area Removed)	_____	Square Feet
H. Total New Hardscape Area:		
1. Uncovered Decks	_____	Square Feet
2. Uncovered Patios	_____	Square Feet
3. Walkways	_____	Square Feet
4. Stairs	_____	Square Feet
5. Rockeries and Retaining Walls	_____	Square Feet

- 6. Other _____ Square Feet
- 7. Total New Hardscape Area
(H1+H2+H3+H4+H5+H6) _____ Square Feet
- I. Total Project Hardscape Area = (F7 - G) + H7 _____ Square Feet
- J. Total Project Hardscape Area = (I/B)x100 _____ % of Lot

Hardscape calculations shown on Plan Sheet # _____

GROSS FLOOR AREA (GFA)

For single family residential development, GFA is the total square footage of floor area, bounded by the exterior faces of the building(s). The GFA includes the floor area of the main building, accessory buildings, garages, attached roofed decks on the second or third story of a single family home, staircases, etc. The GFA does not include second- or third-story uncovered decks or uncovered rooftop decks.

The GFA includes the floor area of the main building, accessory buildings, garages, attached roofed decks on the second or third story of a single family home, staircases, etc. The GFA does not include second- or third-story uncovered decks or uncovered rooftop decks. GFA does not include any portion of a building that is below ground (refer to page 6).

Allowed GFA

- A. R-8.4: 5,000 square feet or 40% of the lot area, whichever is less.
- B. R-9.6: 8,000 square feet or 40% of the lot area, whichever is less.
- C. R-12: 10,000 square feet or 40% of the lot area, whichever is less.
- D. R-15: 12,000 square feet or 40% of the lot area, whichever is less.
- E. All zones: Lots with a lot area of 7,500 square feet or less, the lesser of 3,000 square feet or 45% of the lot area.
- F. All zones: If an accessory dwelling unit is proposed, the 40% allowed GFA may be increased by the lesser of 5 percentile points, or the floor area of the accessory dwelling unit. Provided, this allowance shall not result in a GFA of more than 4,500 square feet or 45% of the lot area, whichever is less.

GFA Modifiers

The GFA calculation for a floor with a ceiling height of 12 to 16 feet, is 150% of the area of the floor.

The GFA calculation for a floor with a ceiling height of more than 16 feet, is 200% of the area of the floor.

The GFA calculation for a stair case shall be counted as a single floor for the first two stories accessed by the stair case. For each additional story above two stories, the stair case shall count as a single floor area.

**Floor plans shall identify rooms with a ceiling height of more than 12 feet and rooms with a ceiling height of more than 16 feet.*

All building areas must be identified and labeled on the site plan. Please distinguish all new construction from existing areas on both your drawing and in the calculations you complete below.

Will you be excluding a portion of the basement floor area? Yes No

If yes, you must provide basement floor area calculations, with your building permit application, that show how you determined what portion of the basement will be excluded. Refer to page 6.

GROSS FLOOR AREA CALCULATIONS

Building Area	Existing Area	Removed Area	New/Addition Area	Total
Upper Floor	_____ Sq. Ft.	_____ Sq. Ft.	_____ Sq. Ft.	_____ Sq. Ft.
Main Floor	_____ Sq. Ft.	_____ Sq. Ft.	_____ Sq. Ft.	_____ Sq. Ft.
Gross Basement Area	_____ Sq. Ft.	_____ Sq. Ft.	_____ Sq. Ft.	_____ Sq. Ft.
Garage/ Carport	_____ Sq. Ft.	_____ Sq. Ft.	_____ Sq. Ft.	_____ Sq. Ft.
Total Floor Area	_____ Sq. Ft.	_____ Sq. Ft.	_____ Sq. Ft.	_____ Sq. Ft.
Accessory Buildings	_____ Sq. Ft.	_____ Sq. Ft.	_____ Sq. Ft.	_____ Sq. Ft.

Accessory Dwelling Unit 2 nd & 3 rd Story Roofed	_____	Sq. Ft.	_____	Sq. Ft.	_____	Sq. Ft.	_____	Sq. Ft.
Decks	_____	Sq. Ft.	_____	Sq. Ft.	_____	Sq. Ft.	_____	Sq. Ft.
Basement Area	_____	Sq. Ft.	_____	Sq. Ft.	_____	Sq. Ft.	_____	Sq. Ft.
Excluded	_____		_____		_____		_____	
150% GFA Modifier* (main and upper floor x2)	_____	Sq. Ft.	_____	Sq. Ft.	_____	Sq. Ft.	_____	Sq. Ft.
200% GFA Modifier* (main and upper floor x2)	_____	Sq. Ft.	_____	Sq. Ft.	_____	Sq. Ft.	_____	Sq. Ft.
Staircase GFA Modifier* (x2 for a three story staircase, x3 for a four story staircase)	_____	Sq. Ft.	_____	Sq. Ft.	_____	Sq. Ft.	_____	Sq. Ft.
TOTAL Building Area	_____	Sq. Ft.	_____	Sq. Ft.	_____	Sq. Ft.	_____	Sq. Ft.

*Enter the actual room area

- A. Lot Area _____ Square Feet
- B. Zone R-8.4 R-9.6 R-12 R-15
- C. Allowed Gross Floor Area (refer to "allowed GFA") _____ Square Feet
- D. Allowed Gross Floor Area _____ % of Lot
- E. Proposed Gross Floor Area _____ Square Feet
- F. Proposed Gross Floor Area _____ % of Lot

Gross floor area calculations found on Plan Sheet # _____

Basement exclusion calculations found on Plan Sheet # _____

BUILDING HEIGHT

All building height measurements must be taken from existing grade or finished grade, whichever is lower. Existing grade refers to ground surface as it exists at the proposed building perimeter before grading or other alterations take place. Finished grade refers to the ground surface as it exists at the building perimeter after grading or other alterations take place.

Single family new construction and additions are limited to a maximum height of 30 ft. above the Average Building Elevation (ABE) – see section on next pages. The height is measured to the top of the structure. On the downhill side of a sloping lot, the wall façade height is also limited to a height of 30 feet measured from existing or finished grade (whichever is lower) to the top of the exterior wall facade supporting the roof framing, rafters, trusses, etc.

A topographic survey is required at permit application when the proposed building height is within 2 ft. of the allowable building height. The survey must include a statement that attests the average contour elevation within the vicinity of the building footprint to be accurate within 6 inches vertically and horizontally from actual elevations.

BUILDING HEIGHT CALCULATIONS

- A. Average Building Elevation (ABE) calculations located on sheet #: _____
- B. Allowable Building Height (ABE + 30 ft.) _____ Feet
- C. Proposed Building Height _____ Feet
- D. Benchmark Elevation* _____ Feet
- E. Describe Benchmark Location (must be undisturbed throughout project) _____

- F. Sloping lot (Downhill side)- maximum height of top of exterior wall façade above lowest existing grade (30-ft max) _____ Feet
- G. ABE and Allowable Building Height Shown on elevations plan sheet # _____
- H. Topo-survey Accuracy Attested on Plan Sheet # _____

Note: survey must attest to accuracy when proposed building height is within 2 feet of the allowable building height. Please see page 8 for more information on calculating Average Building Elevation (ABE)

*The benchmark elevation is a fixed elevation point on or off site that will not be disturbed during development activity and is used to verify the final building height.

BASEMENT FLOOR AREA CALCULATION

The Mercer Island Development Code allows for the portion of the basement floor area which is below grade to be excluded from the Gross Floor Area. That portion of the basement which will be excluded is calculated as shown:

Portion of Excluded Basement Floor Area = Total Basement Area x

$$\frac{\sum (\text{Wall Segment Coverage} \times \text{Wall Segment Length})}{\text{Total of all Wall Segment lengths}}$$

Where the terms are defined as follows:

- Total Basement Area:** The total amount of all basement floor area.
- Wall Segment** The portion of an exterior wall below existing or finished grade, whichever is lower. It is expressed as a percentage. Refer to example below.
- Coverage:**
- Wall Segment Length:** The horizontal length of each exterior wall in feet.

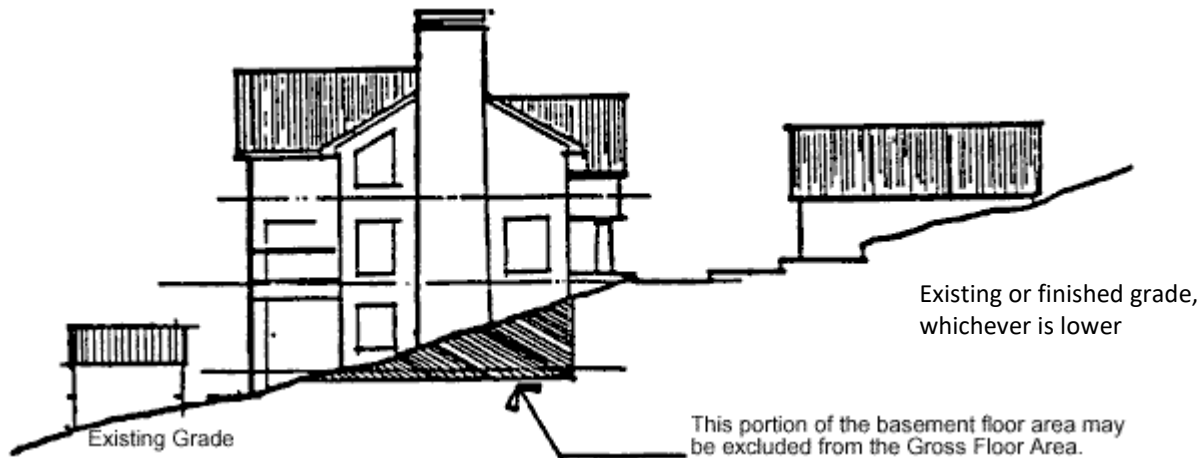

EXAMPLE OF BASEMENT FLOOR AREA CALCULATION

This example illustrates how a portion of the basement floor area may be excluded from the Gross Floor Area. In order to complete this example, the following information is needed:

- a. A topographic map of the existing (e) grades and showing proposed finished (f) grades.
- b. Building plans showing dimensions of all exterior wall segments and floor areas.
- c. Building elevations showing the location of existing and finished grades in relation to basement level.

Step One

Determine the number and lengths of the Wall Segments.

Step Two

Determine the Wall Segment Coverage (in %) for each Wall Segment. In most cases this will be readily apparent, for example a downhill elevation which is entirely above existing and finished grade. In other cases, where the existing contours are complex, an averaging system shall be used. Refer to illustration.

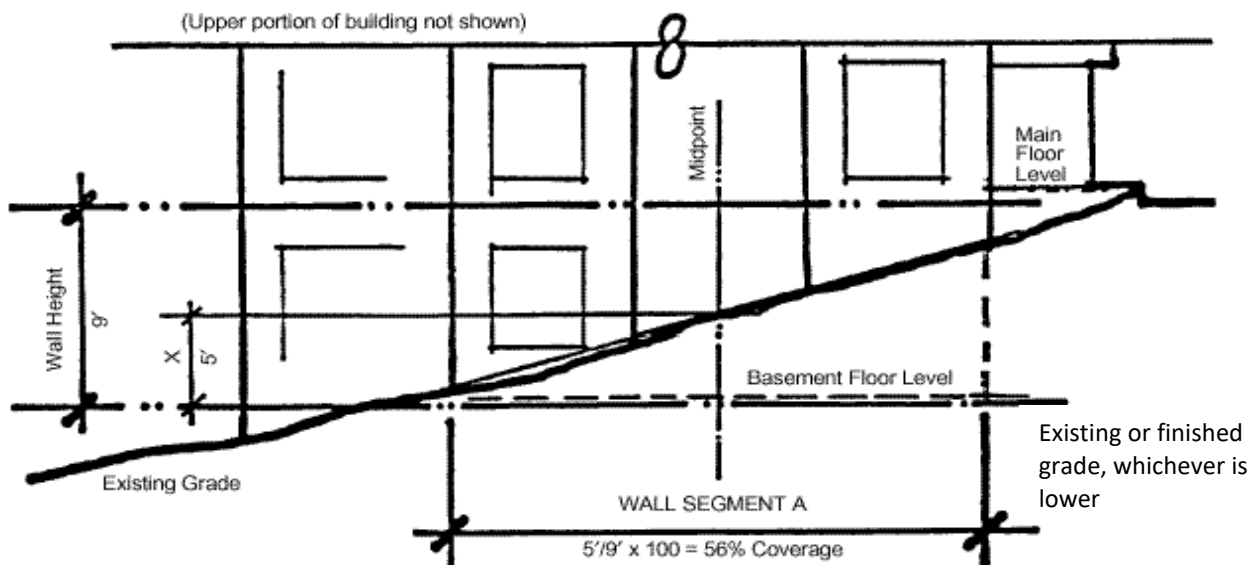
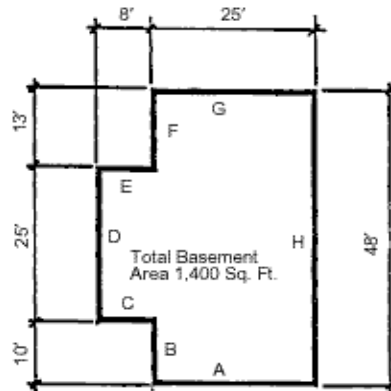

Step Three

Multiply each Wall Segment Length by the percentage of each Wall Segment Coverage and add these results together. Divide that number by the sum of all Wall Segment Lengths. This calculation will result in a percentage of basement wall which is below grade. (This calculation is most easily completed by compiling a table of the information as illustrated below.)

Wall Segment	Length x	Coverage=	Result
A	25'	56%	14%
B	10'	0%	0%
B	8'	0%	0%
D	25'	0%	0%
E	8'	0%	0%
F	13'	0%	0%
G	25'	60%	15%
H	48'	100%	48%
Totals	162'	NA	77%

Step Four

Multiply the Total Basement Floor Area by the above percentage to determine the Excluded Basement Floor Area. Portion of Excluded Basement Floor Area Calculation below

$$1,400 \text{ Sq. Ft.} \times \frac{(25' \times 56\% + 10' \times 0\% + \dots + 25' \times 60\% + 48' \times 100\%)}{162'}$$

$$= 1,400 \text{ Sq. Ft.} \times 47.53\%$$

$$= 665.42 \text{ Sq. Ft. Excluded from the Gross Floor Area}$$

CALCULATING AVERAGE BUILDING ELEVATION (ABE)

No part of a structure may exceed 30 feet in height above the "Average Building Elevation" to the top of the structure, except that on the downhill side of a sloping lot the structure shall not extend to a height greater than 30 feet measured from existing or finished grade to the top plate of the roof; provided the roof ridge does not exceed 30 feet in height above the "Average Building Elevation." ABE is defined as: The elevation established by averaging the elevation at existing or finished grade, whichever is lower, at the center of all exterior walls of the completed building.

NOTE:
INCOMPLETE
AVERAGE BUILDING
ELEVATION
INFORMATION
COULD
SUBSTANTIALLY
DELAY THE
PROCESSING OF
YOUR APPLICATION

AVERAGE BUILDING ELEVATION FORMULA:

$$\frac{(\text{Mid-point Elevation of Individual Wall Segment}) \times (\text{Length of Individual Wall Segment})}{(\text{Total Length of Wall Segments})}$$

—OR—

$$\frac{(Axa)+(Bxb)+(Cxc)+(Dxd)+(Exe)+(Dxd)+(Exe)+(Fxf)+(Gxg)+(Hxh)}{a + b + c + d + e + f + g + h}$$

WHERE: A,B,C,D... = Lower of Finished or Existing Ground Elevation at Midpoint of Wall Segment

AND: a,b,c,d... = Length of Wall Segment Measured on Outside Wall

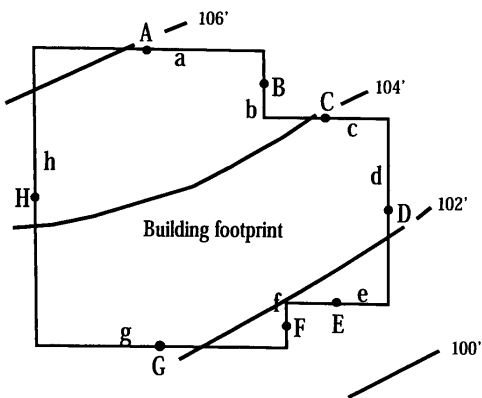

MIDPOINT ELEVATION	WALL SEGMENT LENGTH
A = 105.9 feet	a = 30 feet
B = 104.7 feet	b = 9 feet
C = 103.7 feet	c = 17 feet
D = 102.7 feet	d = 25 feet
E = 101.6 feet	e = 13 feet
F = 101.7 feet	f = 6 feet
G = 102.2 feet	g = 34 feet
H = 104.5 feet	h = 40 feet

ABE CALCULATION:

$$\frac{(105.9)(30)+(104.7)(9)+(103.7)(17)+(102.2)(25)+(101.6)(13)+(101.7)(6)+(102.2)(34)+(104.5)(40)}{30 + 9 + 17 + 25 + 13 + 6 + 34 + 40}$$

$$\frac{18023'}{174'} = 103.6' \text{ Average Building Elevation (ABE)}$$

NOTE: This example is not to scale. Site plans submitted to the building department must be to scale.

BEFORE SUBMITTING YOUR CONSTRUCTION DRAWINGS, CHECK TO SEE THAT YOU HAVE PROVIDED THE INFORMATION BELOW.

- The site plan and the elevation drawings must be drawn to scale, for example 1" = 20', and based on a survey.
- Clearly show existing topography on your site plan. Topography should be shown in 2' increments.
- Submit (with the site plan) your average building elevation calculations using the formula provided on page 8.
- Indicate on an elevation drawing where the average building elevation strikes the building and the proposed ridge elevation (see below for example).
- Elevation drawings for all sides of the building.
- Indicate on the site plan the elevation of the finished floor or garage slab.
- Indicate the elevation and location of a fixed point (benchmark) within the ADJACENT RIGHT-OF-WAY or other point approved by the Building Official. The benchmark elevation and location must be provided and cannot be a part of the proposed structure. Note: Benchmark must be established, verified by a licensed surveyor and remain during construction so height can be verified when completed.
- For additions, you must provide an average building elevation calculation for the entire structure.
- If a portion of the basement floor area will be excluded from the gross floor area, provide the exclusion calculations with your site plan. The formula for basement area exclusions is shown on page 6.
- Indicate ceiling heights greater than 12' and greater than 16' on floor plans.

CROSS-SECTION REPRESENTATION OF ABE

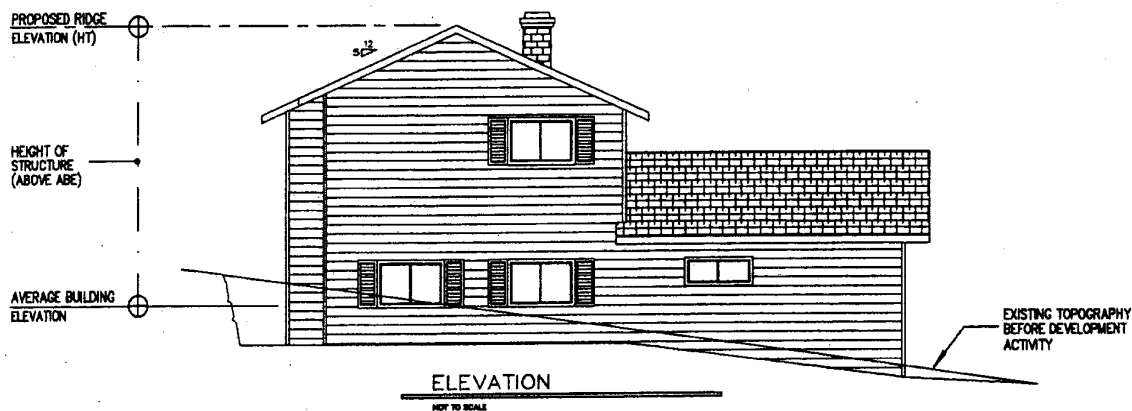

EXHIBIT C

October 5, 2022

Molly McGuire
Assistant Planner
Community Planning & Development
City of Mercer Island
9611 SE 36th Street
Mercer Island, WA 98040
Molly.McGuire@mercerisland.gov

VIA EMAIL AND MAIL

**Re: Comment Letter for Proposed Redevelopment of 6950 SE Maker Street
Permit No. 2207-019**

Dear Ms. McGuire,

On behalf of our client, Dan Grove, we submit these comments on the permit application for the proposed demolition and rebuild of the home located at 6950 SE Maker Street (the “Strand Property”) pending under Permit No. 2207-019 (the “Permit”). Mr. Grove owns the house immediately adjacent to the east of the Strand Property and is acutely familiar with the issues discussed in this letter. Mr. Grove respectfully requests notice and a copy of the permit decision once made by the City.

Mr. Grove reviewed the permit application materials and design plans and identified several problems that need addressing before any permit can be issued in compliance with Mercer Island Development Code. These include the miscalculation of elevation and existing grade, gross floor area, and building and facade height. Additionally, an “Exceptional Tree” was severely damaged to enable the proposed demolition and rebuild of the Strand Property home.¹ The following paragraphs address each of these issues in turn.

¹ The project also raises significant safety concerns, which will be further detailed in an additional comment letter to be submitted by Mr. Grove.

1. The Permit Application Miscalculates Existing Grade

First, the existing grade and elevations of the lot were incorrectly identified in the permit materials.

Mercer Island City Code defines “existing grade” as the surface level at any point on the lot prior to alteration of the ground surface.² MICC 19.02.020(E). “Alteration” is any human-induced action which impacts the existing condition of the area, including but not limited to grading, filling, dredging, draining, channeling, and paving (including construction and application of gravel). MICC 19.02.020(A). Thus, existing grade is the grade prior to any development.

Existing grade is calculated in one of two ways: first, “[w]ithout concrete evidence or verification from a previous survey document, as accepted by the City Code Official, the existing grade underlying the existing structure will be used as the elevation for the proposed development.”³ Under this first method, which assumes calculations must proceed “without a survey of the pre-development conditions,” existing grade “shall be interpreted as the elevation of a point on the surface of the earth immediately adjacent to or touching a point on the exterior wall of a proposed structure.”⁴

Second, “[i]f a current survey document is available, the applicant may establish existing grade by interpolating elevations within the proposed footprint from existing elevations outside of the proposed footprint.”⁵ Here, ample “concrete evidence” and “verification from a previous survey document” are available. This information enables interpolation and clarifies the actual existing grade at the Strand Property. Regardless, it appears the Plan Set calculations follow neither of these two approved methods.

At the Strand Property, pre-development surveys of the properties to the north and south make it possible “to interpolate the approximate topographic elevations of the lot previous to the most recent development.”⁶ It does not appear that the Permit applicant considered this data, which destroys the accuracy of various calculations within the Permit application, including average building elevation, maximum building height, and gross floor area. Each of these calculations necessarily rely on the existing and finished grade being accurately identified. The topographic and boundary survey included in the Plan Set for this Permit application identifies the existing

² “Finished grade” is the surface level at any point on the lot at the conclusion of development. MICC 19.16.010(F). Note, the project plans identify that a 4” concrete slab will be on grade (Sheet S.20).

³ DSG Policy Memorandum, Administrative Interpretation [#DCI12-004](#). See also DSG Policy Memorandum, Administrative Interpretation [#DCI04-04](#) regarding determinations of existing grade for average building elevation.

⁴ *Id.*

⁵ *Id.*

⁶ *Id.*

finished floor elevation of the basement as 228.7' (Sheet 1), the proposed finished floor elevation as 227.72' (Sheet C-2), and the existing grade as 235.24' (Sheet A3.1).

For context, the Strand property was developed in the early 1950's. The existing home is surrounded by large retaining walls and rockeries to the south, west and east, each of which contain large amounts of fill that altered the grade. Further, the lot has been modified extensively from its original grade. Data, including surveys and geotechnical studies, from the time period of development show the existing grade of the north and south boundaries of the property. Specifically, the following pertinent data is enclosed with this comment letter:

- Attached as **Exhibit A** is a survey of the property to the north of the Strand Property, located at 7145 SE 35th Street, dated May 1989 ("7145 Survey"). It includes the grade of the basement of what is now the Strand Property. This survey shows the basement floor elevation as 227.6' and includes the existing grade adjacent to the 6950 home as ranging from 227.7' to the east, to 233.9' to the west.
- Attached as **Exhibit B** is the geotechnical report that was conducted at the same time as the survey of 7145 SE 35th Street ("7145 Geotechnical Report"). It shows no fill in three boreholes north of 6950, and several large trees across 7145. This can be compared to the geotechnical report submitted with this Permit application ("6950 Geotechnical Study"), which shows large amounts of fill in four of the five bore/test holes.
- Attached as **Exhibit C** is a larger scale survey ("1961 Survey") from no later than mid-1961. Based on Mr. Grove's discussions with Mercer Island Public Works and documents from the City of Mercer Island, Maker Street was a gravel road until at least 1963. As a result, this survey represents the original grade of SE Maker Street. This Survey shows the property roughly seven years after its initial development and aligns with the 7145 Survey.
- Attached as **Exhibit D** is an overlay of this survey showing five-foot contours (shown in green) from the edges of the 6950 property and the proposed structure (shown in yellow).
- Attached as **Exhibit E** is a depiction of the topographic data and bore/test hole data overlaid upon the 6950 Geotechnical Study for reference.

The existing grade of the lot slopes down primarily from east to west in line with the slopes shown in the 7145 Survey (Exhibit A). The corner elevations below are the result of using the interpolated contours from Exhibit D and Exhibit E. The table below compares data from Exhibits A through E, and shows that the existing elevation of the proposed structure is closer to 226.6'–226.75'.

Structure Corner	7145 Survey	1961 Survey	Difference Between Surveys
NW	223'	225'	-2.0'
NE	231'	231'	0.0'
SE	230'	229'	+1.0'
SW	223'	222'	+1.0'

Mr. Grove respectfully requests that the City incorporate this data into its review of the Permit application, along with the data he offers in his own letter that he will be submitting separately.

2. The Permit Application Miscalculates Gross Floor Area

Second, the permit materials incorrectly exclude the basement area (and garage) from the gross floor area calculation.

Gross Floor Area (“GFA”) is the total square footage of floor area bounded by the exterior faces of the building. MICC 19.16.010(G). For single family homes, GFA encompasses the main building including any attached accessory buildings, all garages and covered parking, and that portion of the basement which projects above the lower of existing grade or finished grade. *Id.* For the Strand Property (located in zone R-8.4), the gross floor area cannot exceed 5,000 square feet or 40% of the lot area, whichever is less. MICC 19.02.020(D)(1)–(2). Here, the Permit application materials identify the lot area as 8,750 square feet. Forty percent of the lot area equals 3,500 square feet.⁷ Therefore, the GFA for this rebuild cannot exceed 3,500 square feet.

The Site Development Information worksheet and Plan Sheet A1.0 identify the following:

Area	Square Footage
Upper Floor	1,686 sq. ft.
Main Floor	1,750 sq. ft.
Decks	62 sq. ft.
Basement and Garage Area (excluded)	1,575 sq. ft.
Total GFA (w/exclusions)	3,498 sq. ft. (39.9%)

This information incorrectly excludes the full basement area. The Mercer Island Development Code does not allow the total basement area to be excluded out-right, as the Permit applicant did

⁷ See Site Development Information Worksheet at page 4 to 5.

here. See MICC 19.02.020(D). Instead, only that “portion of the basement floor area from the gross floor area which is below the existing or finished grade, whichever is lower” may be excluded. MICC 19.16.010(G).

To calculate the basement floor area that may be excluded, as described in Appendix B of the Code, one must (1) review a topographic map of the existing grades and the proposed finished grades, (2) review the building plans showing dimensions of all exterior wall segments and floor areas, and review the building elevations showing the location of existing and proposed finished grades in relation to basement level, (3) determine the number and lengths of the Wall Segments, (4) determine the Wall Segment Coverage (in %) for each Wall Segment, (5) multiply each Wall Segment Length by the percentage of each Wall Segment Coverage and add these results together, and (6) divide that number by the sum of all Wall Segment Lengths.

The applicant does not appear to have provided such calculation in the Permit materials. As a result, the proposed elevation and grade for this development are not accurate, and the GFA contribution from the basement is actually higher than described. We calculate the GFA contribution is roughly 1,293 square feet, making the correct Gross Floor Area closer to 4,791 square feet. This exceeds the 3,500 square feet permitted by the Code.

As shown in the table below, this is in large part due to the correctly computed existing grade’s being lower than provided in the permit Plan Set.

Wall Segment	Existing Grade (per surveys)	Existing Grade (per plan set)	FF Elevation (per plan set) ⁸	Actual Coverage %
West Wall	223’	not shown	227.4’	0 %
North Wall	223’- 231’	not shown	227.4’	9.4 % ⁹
East Wall	230’- 231’	235.4’	227.4’	40.75 %
South Wall	227’	not shown	227.4’	0 %

⁸ Plan Set V2 Sheet C-2, Sheet A3.1 (FF refers to finished floor).

⁹ Based on our review, approximately 15’ of the east end of the north wall has a finished floor below existing grade, ranging from 0’ near the midpoint of the wall to roughly 3.5’.

Basement Area (to be included)	1,293 sq. ft.
Estimated Total GFA (w/correct exclusions)	4,791 sq. ft.

3. The Permit Application Miscalculates Average Building Elevation and Building Height

Third, the Permit applicant appears to have miscalculated the “Average Building Elevation” (“ABE”) for this project, which also led to an inaccurate maximum building height calculation. ABE is the reference point on the surface topography of a lot from which building height is measured. The elevation in this zone (R-8.4), is established by averaging the elevation at existing grade or finished grade, whichever is lower. MICC 19.16.010(A). The formula is as follows (MICC 19.02.020(E)):

$$\text{Average Building Elevation} = (\text{Weighted Sum of the Mid-point Elevations}) \div (\text{Total Length of Wall Segments})$$

Evidence from pre-development survey documents shows the existing grade as several feet lower than the existing grade as calculated in the design plans. This translates to an ABE closer to 227.0’, not 233.06’ as identified in the Plan Set (Sheet A3.1).

Wall	End 1 Elevation	End 1 Elevation Type	End 2 Elevation	End 2 Elevation Type	Midpoint Elevation	Midpoint Elevation Type	Length
West	223’	Existing	223’	Existing	223’	Existing	45’
North	223’	Existing	231’	Existing	227.3’	Existing	35’
East	230’	Existing	231’	Existing	230.5’	Existing	45’
South	223’	Existing	227.74’	Finished	227.5’	Finished	45’

Because the ABE was incorrectly calculated, the maximum building height of the proposed structure was also miscalculated. As designed, the proposed structure exceeds the building height limit set by the Mercer Island Development Code.

Buildings cannot exceed 30 feet in height above the ABE to the highest point of the roof. MICC 19.02.020(E). ABE is established by averaging the elevation at existing grade or finished grade, whichever is lower. MICC 19.16.010(A). “Building height” is the vertical distance measured from the average building elevation to the highest point of the roof structure excluding appurtenances, but including railings.¹⁰ MICC 19.16.010(B). As a result, the height of the proposed structure is at least 4 feet above the maximum allowed by the Mercer Island Development Code.

The plan set for the proposed development identifies the following:¹¹

Summary of Permit’s Incorrect Calculations	
(Inaccurate) ABE	233.06’
Height Limit	30’
(Inaccurate) Maximum Allowable Building Height	263.06’
Proposed Height	261.43’

¹⁰ “Appurtenances” are defined as a structure which is necessarily connected to the use and enjoyment of a single-family dwelling. An appurtenance includes but is not limited to antennas, lightning rods, plumbing stacks, flagpoles, electrical service leads, chimneys and fireplaces, garages, decks, driveways, utilities, fences, swimming pools, hot tubs, landscaping, irrigation, grading outside the building footprint which does not exceed 250 cubic yards and other similar minor construction. MICC 19.16.010(A).

¹¹ See Sheet A3.1

But, instead of 263.06', the correct maximum allowable height is closer to 257.0' because the ABE is more accurately 227.0'. The relevant surveys and design plans show the correct calculations for this project are as follows:

Summary of the Correct Calculations	
(Corrected) ABE	227.0'
Height Limit	30'
(Corrected) Maximum Height	257.0'
Proposed Height	261.43'

4. The Design Improperly Exceeds Maximum Building Height on Downhill Building Façade

Further, the design plans exceed the maximum building height limit by at least an additional four feet when measured on the downhill side of the sloping lot. MICC 19.02.020(E)(2) states that a "maximum building facade height on the downhill side of a sloping lot shall not exceed 30 feet in height." Building facade height is "measured from the existing grade or finished grade, whichever is lower, at the furthest downhill extent of the proposed building, to the top of the exterior wall facade supporting the roof framing, rafters, trusses, etc." *Id.* Rooftop railings may not extend above the maximum allowed height for the main structure. MICC 19.02.020(E)(3).

The Strand Property slopes down primarily from east to west. The existing grade at the furthest downhill extent of the proposed building ranges from 223' to 261.43'.¹² And, the rooftop railings described in the Plan Set add approximately 3 feet to the structure (Sheet A3.1). Measuring from the existing grade at the furthest downhill extent to the top of the exterior wall façade equals roughly 8 feet above the allowable 30-foot limit. The table below provides this comparison:

¹² See Section 1 (regarding Existing Grade) and Section 3 (regarding ABE and Building Height). See also the Geotechnical Report submitted with the Permit application which also describes the slope areas on the Strand Property and identifies it as a "steep slope hazard area." Report at 2.

Comparison of Exceedances: Max. Building Height & Max. Height on Downhill Facade	
Height Limit Exceeded by: (w/railings)	4.43'
Height Limit of Downhill Facade Exceeded by: (w/railings)	8.43'
Height Limit of Downhill Facade Exceeded by: (w/o railings)	5.43'

5. The Permit Applicant Violated Critical Tree Protection Regulations

Finally, the applicant severely damaged an “Exceptional Tree” as defined by the Mercer Island Tree Code (MICC 19.10) prior to and in anticipation of the rebuild on the Strand Property.¹³ The purpose of the Tree Code is “to encourage building and site design to minimize tree removal, and to establish standards and procedures that will result in the retention of trees on Mercer Island.” The City has recognized that trees are beneficial to our community in various ways. Trees:

- Contribute to the residential character;
- Provide a public health benefit;
- Provide wind protection, ecological benefits to wetlands and watercourses, and aid in the stabilization of geologically hazardous areas;
- Improve surface water quality and control and benefit Lake Washington;
- Reduce noise and air pollution;
- Enhance the reasonable enjoyment and use of private property by the property owner;
- and
- Provide delivery of reliable utility service.

¹³ “Tree, exceptional” is defined as a tree or group of trees that because of its unique historical, ecological, or aesthetic value constitutes an important community resource. An exceptional tree is a tree that is rare or exceptional by virtue of its size, species, condition, cultural/historic importance, age, and/or contribution as part of a tree grove. Trees with a diameter of more than 36 inches, or with a diameter that is equal to or greater than the diameter listed in the Exceptional Tree Table, are considered exceptional trees. MICC 19.16.010(T). The red oak on Mr. Grove’s property fits this definition.

For these reasons, a permit is required to remove any tree with a diameter greater than 10 inches. MICC 19.10.010(A). If the tree is being removed as part of a development (for example, to allow for construction of a new home) then a full Permit application is required, and other retention and replacement requirements apply. *See* MICC 19.10.010(C); MICC 19.10.060. Some actions, like pruning, can be exempt from permitting requirements.¹⁴ MICC 19.10.030. But this exemption only applies if the act will not significantly damage the tree.

Prior to this development, on or around November 9, 2021, Mr. Grove’s oak tree, which is an “Exceptional Tree”, was sharply cut back and significantly damaged. The arborist that conducted the work severed two 24” trunks, which significantly damaged the tree, altered the view from Mr. Grove’s property, and left large stumps and unnatural gaps in the skyline.¹⁵ The arborist, Enterprises Superior NW—who prepared the “Pre-Construction Assessment for lot re-development at 6950 SE Maker Street,” (the “Assessment”) submitted with the Permit—application acknowledged this damage. The Assessment states that the oak tree, roughly nine months after the initial cutting, is “exhibiting signs of stress in the upper canopy” and a “heavy epicormic response growth” in the lower canopy.¹⁶

At the time of the cutting, the Permit Applicant represented to Mr. Grove that no tree retention development permit was necessary because the Permit Applicant had no plans to develop the property.¹⁷ Shortly after the cutting however, Mr. Grove learned that the Permit applicant did, in fact, intend to demolish her existing home and to rebuild another. Mr. Grove is aware from a conversation with Tim McHarg (Community Planning and Development Department) on November 23, 2021, that the City also learned of these development plans in a meeting just seven days after the cutting, on November 16, 2021. The Permit applicant submitted the following statement to the City in preparation of a November 16, 2021 meeting with the City regarding construction plans:¹⁸

¹⁴ Mercer Island’s Tree Code defines pruning of a tree as “crown thinning, crown cleaning, windowing or crown raising but not including crown topping of trees or any other practice or act which is likely to result in the death of or significant damage to the tree.” MICC 19.10.030.

¹⁵ It is important to note that the MICC 19.10.060(A)(3) requires that exceptional trees with a diameter of 24 inches or more be retained, and removal of an exceptional tree with a diameter of 24 inches or more “will limit the constructable gross floor area to less than 85 percent of the maximum gross floor area allowed under chapter 19.02 MICC.” Thus, the gross floor area calculation, as described in Section 2 of this comment letter, should be further limited as a result of this tree removal. If reduced to 85 percent, the Permit applicant’s gross floor area calculation is exceeded to an even greater degree than described in Section 2 of this letter.

¹⁶ Assessment at page 2.

¹⁷ Under normal circumstances, a permit is required if development plans are known. MICC 19.10.010.

¹⁸ This information is available at the following link and was provided by the City in response to a Public Records Act request. *See* [Request 21-714](#).

“I have included my recent survey for you to see where and how my footprint sits on my parcel. It also shows all the impervious surfaces. My house is a tri level design with no crawlspace and built entirely at grade, on slab, on all levels. I fully expect to meet again with the city for a design review before moving forward, but I need this initial meeting regarding my existing footprint placement on my parcel.”

Soon after these conversations, the Permit applicant also began submitting various pre-construction reports associated with this permit application. At this time, the Permit applicant still represented to Mr. Grove that there were no development plans for this property.

The following excerpt from the Assessment shows the Red Oak Tree on Mr. Grove’s property as Tree #5:



The Assessment states: “[The] Red oak (*Quercus rubra*) easily 40” DSH, 50’ tall in the highest reaches, spreads as much as 45’ north and south, around 35’ east, but was cut back quite hard on the west and extends no more than 18’ to that side (Figure 6). The base of the tree is 25’ south of the northeast corner and 10’ on center east of the east line. It sits on top of a large stone retaining wall that is near 5’ tall and fully on the neighbor’s lot (Figure 7).”¹⁹ The Assessment further states that “[i]f grade changes due to landscaping are proposed later in the project they should be analyzed for potential impact prior to implementation.”²⁰

¹⁹ Assessment at 2.

²⁰ Assessment at 3.

October 5, 2022
Page 12

The bottom line is that this tree was cut without proper planning and permitting, even as Ms. Strand represented that she had no plans to develop the property. Mr. Grove requests the City closely review any permit plans that would impact this tree, or other important trees near this property.

Mr. Grove greatly appreciates the City's attention to these matters. We would be happy to provide any additional information or answer any of the City's questions. Please feel free to contact me at ZDavison@perkinscoie.com.

Sincerely,



Zachary E. Davison

ZED:glg

EXHIBIT A

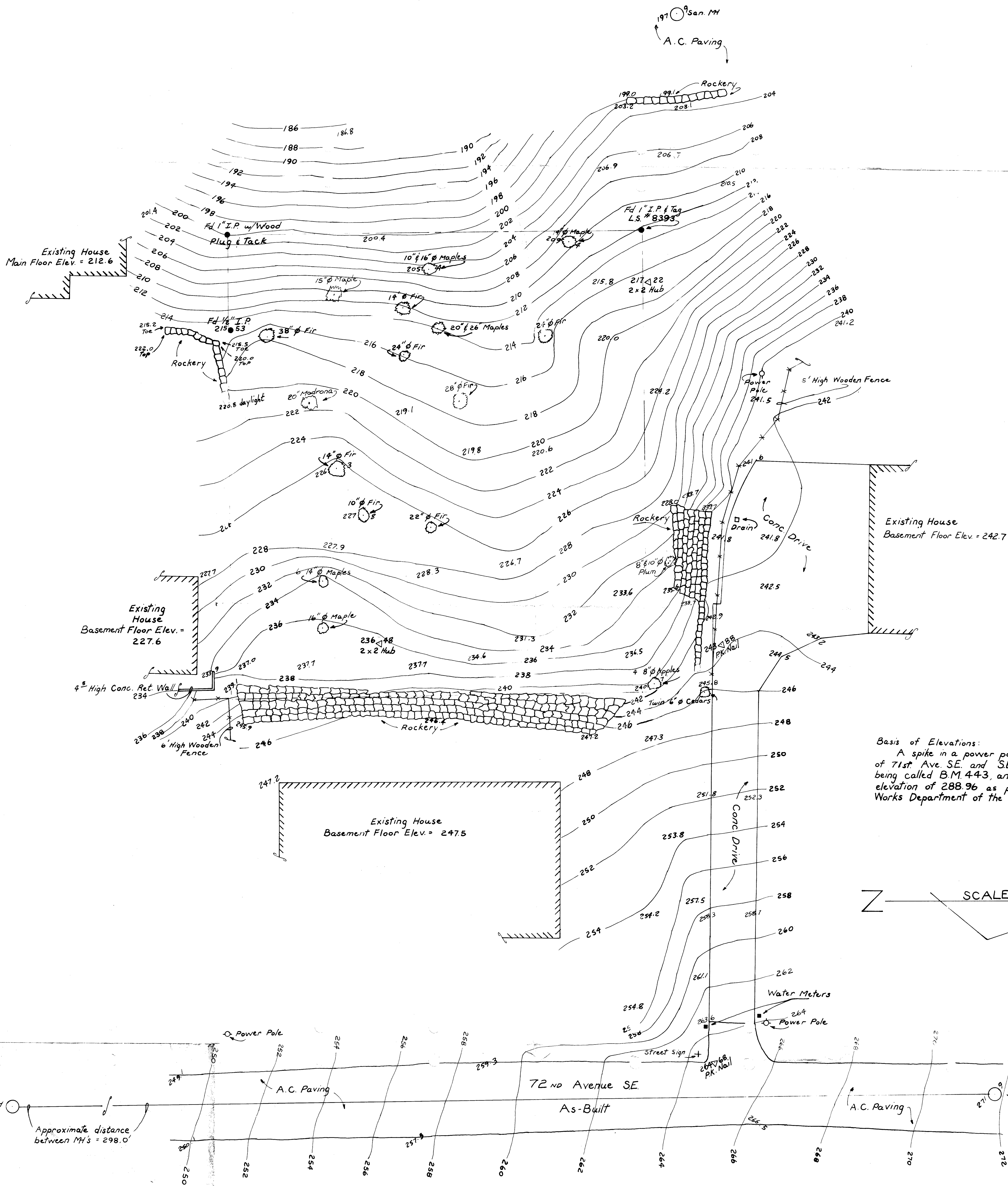

Basis of Elevations:
 A spike in a power pole at the intersection
 of 71st Ave. SE. and SE. 32nd Street,
 being called B.M. 443, and having an
 elevation of 288.96 as per the Public
 Works Department of the City of Mercer Island.

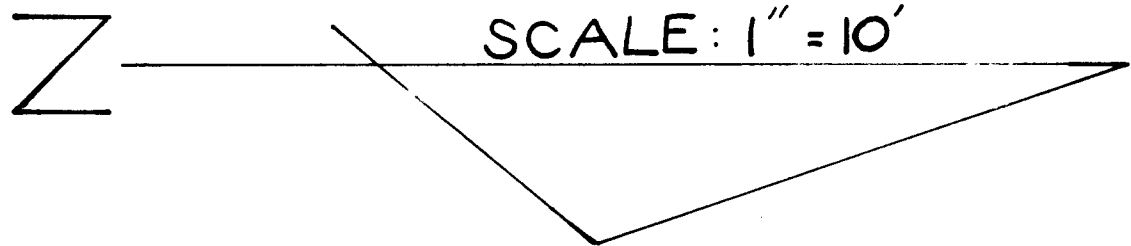

Topographic Survey

CLIENT
 Myrvang Architects

PROJECT
 Pederson Residence

Richard E. Strong

DRS D.R. STRONG Consulting Engineers Inc.
 10602 N.E. 38th PLACE, SUITE 101 • KIRKLAND, WA. 98033 (206) 827-3063
 ENGINEERS • PLANNERS • SURVEYORS (206) 852-9334

DRAWN JMR DATE May 1989 DRAWING NO. 89-848
 CHECKED GES SCALE 1" = 10' SHEET

EXHIBIT B



REPORT
GEOTECHNICAL CONSULTATION
PROPOSED RESIDENCE
7100 BLOCK, SOUTHEAST 35TH STREET
MERCER ISLAND, WASHINGTON
FOR
MR. ART PEDERSON

FILE COPY

May 9, 1989

**Consulting Geotechnical
Engineers and Geologists**

Mr. Art Pederson
4735 West Mercer Way
Mercer Island, Washington 98040

Dear Mr. Pederson:

Report
Geotechnical Consultation
Proposed Residence
7100 Block, Southeast 35th Street
Mercer Island, Washington
File No. 1700-01-6

INTRODUCTION

This report presents the results of our geotechnical consultation at the site of your proposed residence on Southeast 35th Street on Mercer Island. The scope of our services was based on discussions with your architect, Mr. Steve Myrvang, and a surface reconnaissance of the site. Written authorization for our services was provided by you on April 26, 1989. No plan of the site has been provided. The location and dimensions of the site were provided verbally by Mr. Myrvang.

We understand that you are planning to construct a two- or three-story residence to be supported by a combination of piles and spread footings. We further understand that the City of Mercer Island requires that a geotechnical study be completed in order to satisfy the Department of Community Development Guideline No. 22.

The purpose of our work is to provide you with recommendations and design criteria for the geotechnical aspects of the new residence and to address the City's requirements for a geotechnical study. Our specific scope of services includes:

Mr. Art Pederson
May 9, 1989
Page 2

1. Review currently available information regarding soil and ground water conditions in the vicinity of the site.
2. Perform a geologic reconnaissance of the site and adjacent areas.
3. Explore subsurface conditions at the site by means of hand-dug test pits and auger holes.
4. Develop recommendations for foundation support of the structure, including shallow and deep foundation support as appropriate.
5. Provide design parameters for the lateral resistance of the structure, including lateral earth pressures for use in the design of walls or piles, as required.
6. Provide recommendations for site grading and earthwork, including compaction and fill material requirements.
7. Provide recommendations for surface and subsurface drainage requirements, including erosion control.

SITE CONDITIONS

The site is located immediately south of Southeast 35th Street (extended) and immediately west of the existing residence at 3507 - 72nd Avenue Southeast, as shown on the Site Plan, Figure 1. The site is rectangular in shape, and measures 112.5 feet east-west by 100 feet north-south. Existing residential housing borders the site on all sides.

The site is situated within a westward sloping swale. The physical control for developing the Site Plan was based on two property corner stakes in the northwest and southwest corners and the site dimensions provided. The accuracy of the site features as shown on our Site Plan should be regarded accordingly.

The site slopes steeply downward at about 45 degrees for about 8 to 15 feet from the east property line to a moderately sloping area at about 15 degrees that comprises the main portion of the site. About 30 feet from the west property line, the slope steepens to about 35 degrees

Mr. Art Pederson
May 9, 1989
Page 3

through a vertical height of 30 feet to a 20-foot-wide nearly level bench west of the site. The total relief from the east property line to the bench west of the site is approximately 70 feet, yielding an overall slope of 2H:1V (horizontal to vertical). The north property line is bordered by a rockery and fill embankment varying in height from 5 to 10 feet. The topography of the property to the south is similar.

The site is vegetated with scattered deciduous trees, primarily maple and five relatively large and straight-trunked Douglas fir trees. The understory consists of moderately dense brush.

Shallow subsurface soil and ground water conditions were evaluated by excavating three test holes using hand tools at the locations shown on our Site Plan, Figure 1. Test holes were excavated by a geological engineer from our firm who selected the exploration locations, identified the soils encountered, observed ground water conditions and maintained a detailed log of each exploration. Soils encountered were classified in general accordance with the Unified Soil Classification System described in Figure 2. Logs of the test holes are presented in Figure 3.

The test holes indicate that the near-surface soils across the site consist of 4 to 6 inches of forest duff and topsoil underlain by a loose to medium dense silty sand or sand with silt with variable amounts of gravel to the maximum depth of 42 inches of the test holes. The soils appeared to grade to dense at the maximum depth of the explorations. Based on our previous experience and geologic mapping in the site area, we expect that the soil deposits described above are underlain by glacially consolidated soil.

Based on our observations of the surface topography, the 45-degree sloping embankment bordering the east side of the site probably is fill. No other fill is expected on the remainder of the site.

No surface water or ground water was observed during our site reconnaissance or in the test holes.

Mr. Art Pederson
May 9, 1989
Page 4

CONCLUSIONS AND RECOMMENDATIONS

It is our opinion that the proposed residence may be satisfactorily supported using spread footing and/or pile support, provided that the footings and/or piles are supported on dense to very dense glacially consolidated soil. It must be understood that there is an inherent stability risk associated with any hillside construction; however, it is our opinion that the risk is small for the design life of the residence provided the recommendations in this report are followed.

The on-site soils are moisture sensitive with regard to earthwork performed during wet weather. We recommend that foundation construction be performed only during periods of prolonged dry weather.

SPREAD FOOTINGS

Spread footings should be founded on the dense to very dense or hard glacially consolidated soil. This should typically require the excavation depth for the footings to range up to 3-1/2 feet deep. In the event the footing excavations do not encounter glacially consolidated soil, the footing may be overexcavated and replaced with structural fill, or the allowable bearing pressure should be reduced. We recommend that all footing excavations be examined by a representative of our firm to determine that suitable bearing soils have been exposed. Any unsatisfactory material encountered in these excavations should be overexcavated to the depth determined by our representative.

We recommend that all exterior spread footings be set back at least 5 feet from the top of the steep slope along the west property line and have a minimum depth of embedment below lowest adjacent finished grade of 18 inches. Interior spread footings should also be set back as previously described and have a minimum embedment of 12 inches below lowest adjacent finished grade. Individual column footings and continuous wall footings should have minimum widths of 18 and 15 inches, respectively. Spread footings designed and constructed as recommended above may be designed using an allowable bearing value of 2000 pounds per square foot (psf).

Mr. Art Pederson
May 9, 1989
Page 5

This bearing value applies to the total of all dead plus long-term live loads exclusive of the weight of the footing and any overlying backfill. An increase in this value of up to one-third may be made when considering wind or seismic loading.

We expect that spread footings will experience less than a 1/2-inch settlement for the allowable design loads and will occur essentially immediately on their application. This magnitude of settlement can normally be accommodated by residential structures.

PILE FOUNDATIONS

The building or a portion thereof may also be supported on concrete piles that are drilled down into dense to very dense or hard glacially consolidated soils. The piles may be located on the steep slope along the west property line if required. The following design criteria are based on our experience with using piles at similar sites. We expect a zone of up to 3-1/2 feet of weathered soil that is subject to movement down-slope. For design of piles within this upper 3-1/2-foot zone, we recommend an active lateral load equivalent to a fluid weighing 50 pcf applied over two pile diameters. Passive resistance below the 3-1/2-foot depth may be designed using an equivalent fluid density of 200 pcf. Providing that the pile tip is embedded in dense to very dense or hard glacially consolidated soil and has a minimum embedment depth of 5 feet, an end bearing capacity of 8000 psf is recommended for downward acting loads. The end bearing capacity may be increased to 10,000 psf for a minimum embedment depth of 8 feet.

LATERAL SOIL PRESSURES

Lateral soil pressures which act on subsurface walls will be a function of the nature and compaction of the backfill. In addition, hydrostatic pressure from ground water must be considered.

Assuming the soil behind the wall is drained and the backfill surface is inclined at 15 degrees or less, we recommend a design active lateral earth pressure equivalent to a fluid weighing 40 pcf. We recommend this value be increased to 60 pcf for walls constructed closer than a distance

Mr. Art Pederson
May 9, 1989
Page 6

0.5H from the toe of steeper than 15-degree slopes or rockeries. The value H corresponds to the height of the excavation.

For lateral soil resistance we recommend a passive earth pressure equivalent to 300 pcf where the ground is relatively level. Where the ground surface slopes down at approximately 15 degrees, we recommend this value be reduced to 200 pcf. For conventional walls, a coefficient of friction of 0.4 can be used between the base of the wall and the soil to provide additional lateral resistance.

SITE GRADING AND EARTHWORK

We recommend the building site be stripped of vegetation and significant organic material including tree roots greater than 4 inches in diameter. We expect that the stripping depths will be quite variable, although it appears that up to about 4 to 6 inches will be necessary in most areas. Greater depths will be necessary in areas with thick vegetation and trees. This material should be wasted off site.

As mentioned previously, the prevailing on-site soil is moisture sensitive, difficult to operate on and very difficult to compact during wet weather. Rubber-tired vehicles and even foot traffic disturb this type of soil when it is above optimum moisture. It also has a moderate erosion potential in place but is easily transported by running water. Therefore, silt fences and other measures will be necessary to control erosion and sediment transport during construction. The forest duff acts as a protective layer to the surficial soil and should be removed only where and when necessary.

Those areas which are stripped or excavated to design subgrade elevations or are to receive structural fill should be probed with a steel rod. Any soft, loose or otherwise unsuitable areas identified during probing should be recompacted if practical or removed and replaced with structural fill. We recommend the probing of the subgrade be observed by a representative from our firm to assess the adequacy of the subgrade conditions and to identify areas needing remedial work.

Mr. Art Pederson
May 9, 1989
Page 7

Structural Fill and Fill Placement: We recommend that fills at the site be kept to a minimum height of 5 feet and no additional soil be imported to the site. All fill necessary in the building area and on slopes should be placed as compacted structural fill subsequent to probing and remedial work as appropriate. The fill should be placed in horizontal lifts not exceeding 10 inches in loose thickness. Each lift must be conditioned to the proper moisture content and then uniformly compacted. Fill placed in the building area should be compacted to at least 95 percent of the maximum dry density as determined by the ASTM D-1557 test procedure.

Fill placed on slopes steeper than 4H:1V should be appropriately benched and keyed into dense native soils. We recommend permanent structural fill slopes be no steeper than 2H:1V. The compaction equipment should be run over the edge of the fill to provide good compaction or the fill can be overbuilt by several feet and cut back to the required slope. Hydroseeding or other erosion protection should be applied immediately.

All structural fill material should be free of organics, debris and other deleterious material with no individual particles larger than 5 inches in diameter. As the amount of fines (that portion passing the No. 200 sieve) increases, the soil becomes increasingly sensitive to small changes in moisture content and adequate compaction becomes more difficult or impossible to achieve, particularly during wet weather. Generally, soils containing more than about 5 percent fines by weight cannot be properly compacted when the moisture content is more than a few percent from optimum.

Most of the on-site soils that are expected to be available for fill possess a fines content greater than 5 percent such that this material could not be used for structural fill except during periods of extended dry weather. It may be necessary to moisture condition this soil by adding water or drying out as appropriate to reach optimum moisture content for compaction.

Mr. Art Pederson
May 9, 1989
Page 8

DRAINAGE

Runoff from the roof of the planned residence or from other impermeable areas such as patios and driveways should not be allowed to discharge on the site. Runoff must be properly collected and tightlined away from the site to a suitable discharge point. We also recommend that irrigation systems be carefully controlled to avoid excessive amounts of water entering the soil.

EROSION

The soils underlying the site have a high potential for erosion during construction. Temporary erosion control will be necessary and should include the proper control of surface water runoff, minimizing the time of exposure in the area stripped during site preparation, and prompt revegetation.

USE OF THIS REPORT

We have prepared this report for use by Mr. Art Pederson and your architect and engineer for developing a portion of this project. GeoEngineers should be retained to review design plans when developed to see that our conclusions and recommendations have been interpreted as intended and also to examine the subgrade before pouring the concrete footings.

The scope of this investigation does not include services related to construction safety precautions and our recommendations are not intended to direct the contractor's methods, techniques, sequences or procedures, except as specifically described herein.

The hand-dug explorations are considered limited in evaluating subsurface conditions. The glacially consolidated soils were not actually penetrated by our explorations, but were interpreted to exist at a depth where hand digging became difficult due to the apparent dense conditions of the soils encountered.

We strongly recommend that our firm be retained to provide monitoring and consultation during construction to confirm that the conditions

Mr. Art Pederson
May 9, 1989
Page 9

encountered are consistent with those indicated by the explorations and provide recommendations for changes should the conditions revealed during construction differ from those anticipated.

Within the limitations of scope, schedule and budget, our services have been executed in accordance with generally accepted practices in this area at the time the report was prepared. No other conditions, express or implied, should be understood.

- o o o -

If there are any questions concerning this report or if we can provide additional services, please call.

Yours very truly,

GeoEngineers, Inc.

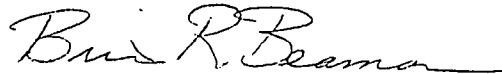

Brian R. Beaman
Geological Engineer

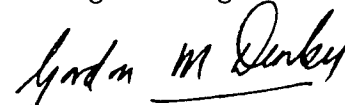

Gordon M. Denby, P.E.
Associate

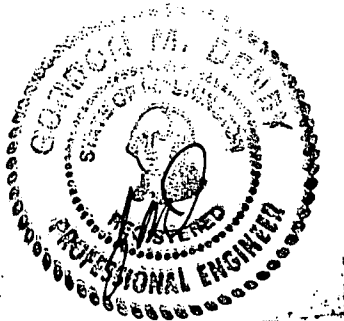

BRB:GMD:cs

Three copies submitted

Attachments

Copyright © 1988 GeoEngineers, Inc., All Rights Reserved

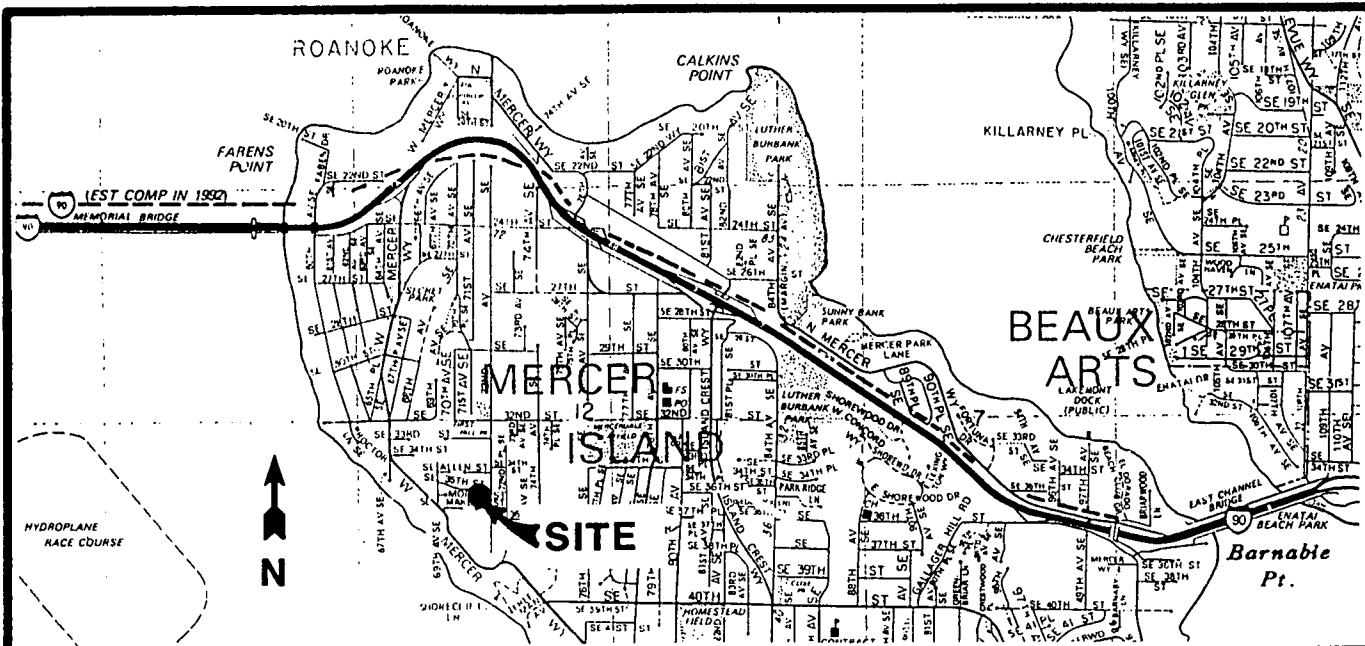

VICINITY MAP

No Scale

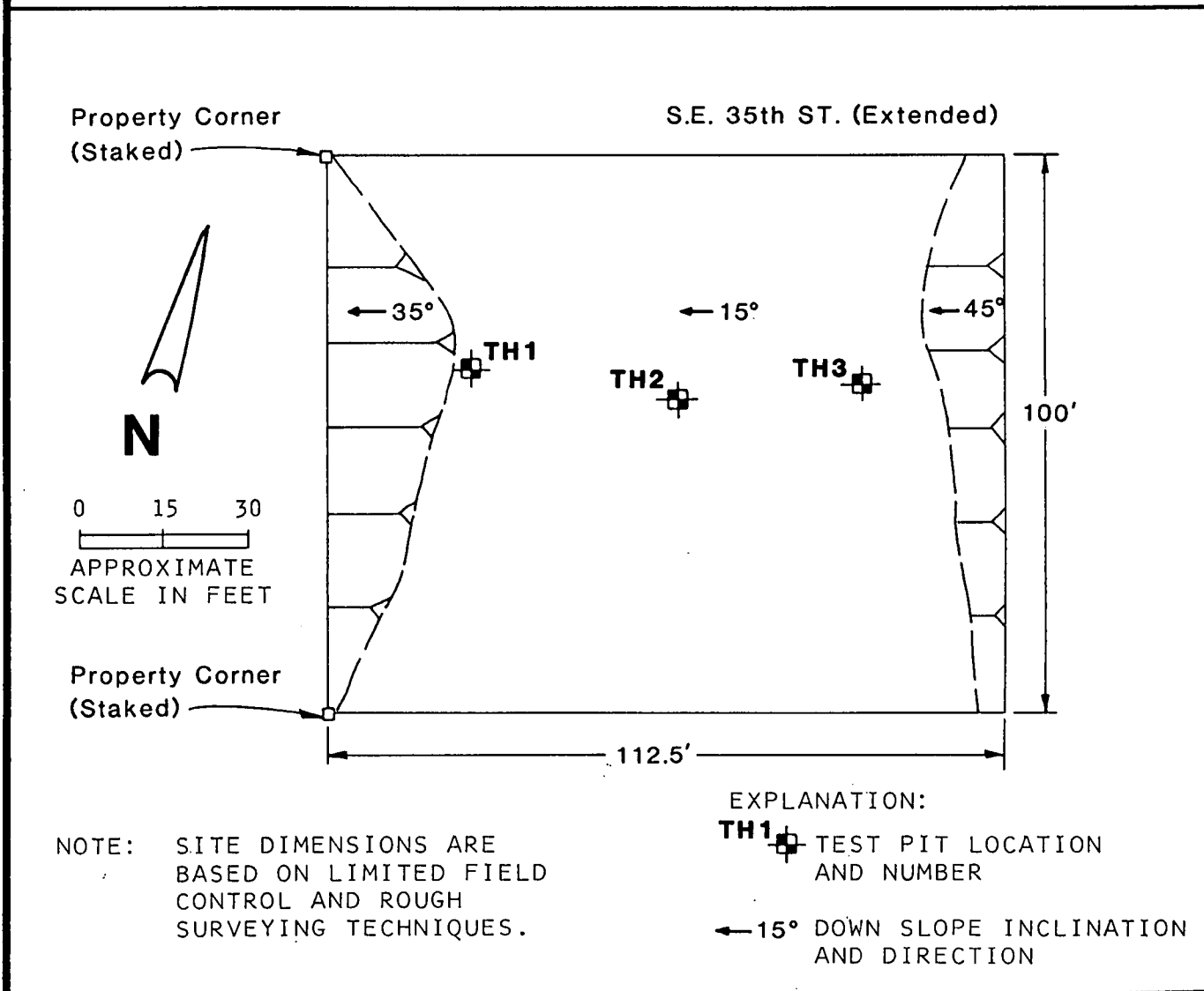

NOTE: SITE DIMENSIONS ARE BASED ON LIMITED FIELD CONTROL AND ROUGH SURVEYING TECHNIQUES.

EXPLANATION:

TH1 TEST PIT LOCATION AND NUMBER

← 15° DOWN SLOPE INCLINATION AND DIRECTION

1700-01-6 BRB:KKT 5-5-89



SITE PLAN

FIGURE 1

SOIL CLASSIFICATION SYSTEM

MAJOR DIVISIONS		GROUP SYMBOL	GROUP NAME
COARSE GRAINED SOILS MORE THAN 50% RETAINED ON NO. 200 SIEVE	GRAVEL MORE THAN 50% OF COARSE FRACTION RETAINED ON NO. 4 SIEVE	CLEAN GRAVEL	GW WELL-GRADED GRAVEL, FINE TO COARSE GRAVEL
			GP POORLY-GRADED GRAVEL
		GRAVEL WITH FINES	GM SILTY GRAVEL
			GC CLAYEY GRAVEL
	SAND MORE THAN 50% OF COARSE FRACTION PASSES NO. 4 SIEVE	CLEAN SAND	SW WELL-GRADED SAND, FINE TO COARSE SAND
			SP POORLY-GRADED SAND
		SAND WITH FINES	SM SILTY SAND
			SC CLAYEY SAND
FINE GRAINED SOILS MORE THAN 50% PASSES NO. 200 SIEVE	SILT AND CLAY LIQUID LIMIT LESS THAN 50	INORGANIC	ML SILT
			CL CLAY
	SILT AND CLAY LIQUID LIMIT 50 OR MORE	INORGANIC	MH SILT OF HIGH PLASTICITY, ELASTIC SILT
			CH CLAY OF HIGH PLASTICITY, FAT CLAY
	ORGANIC	OL ORGANIC SILT, ORGANIC CLAY	
		OH ORGANIC CLAY, ORGANIC SILT	
HIGHLY ORGANIC SOILS		PT	PEAT

NOTES:

- Field classification is based on visual examination of soil in general accordance with ASTM D2488-83.
- Soil classification using laboratory tests is based on ASTM D2487-83.
- Descriptions of soil density or consistency are based on interpretation of blowcount data, visual appearance of soils, and/or test data.

SOIL MOISTURE MODIFIERS:

Dry - Absence of moisture, dusty, dry to the touch

Moist - Damp, but no visible water

Wet - Visible free water or saturated, usually soil is obtained from below water table

LOG OF TEST HOLE

DEPTH BELOW GROUND SURFACE (INCHES)	GROUP SOIL CLASSIFICATION SYMBOL	DESCRIPTION
<u>TEST HOLE 1</u>		
0 - 4"		FOREST DUFF AND TOPSOIL
4" - 18"	SM	BROWN SILTY FINE SAND WITH A TRACE OF GRAVEL (MEDIUM DENSE, MOIST)
18" - 30"	SP-SM	BROWN FINE TO MEDIUM SAND WITH SILT AND GRAVEL (MEDIUM DENSE, MOIST)
GRADES TO DENSE AT 30 INCHES		
TEST HOLE COMPLETED AT 30 INCHES ON 4/27/89		
OCCASIONAL ROOTS TO 18 INCHES		
NO FREE GROUND WATER OBSERVED		
<u>TEST HOLE 2</u>		
0 - 4"		FOREST DUFF AND TOPSOIL
4" - 18"	SM	BROWN SILTY FINE SAND WITH A TRACE OF GRAVEL (MEDIUM DENSE, MOIST)
18" - 36"	SP-SM	BROWN FINE TO MEDIUM SAND WITH SILT AND GRAVEL (MEDIUM DENSE, MOIST)
GRADES TO DENSE AT 36 INCHES		
TEST HOLE COMPLETED AT 36 INCHES ON 4/27/89		
OCCASIONAL ROOTS TO 24 INCHES		
NO FREE GROUND WATER OBSERVED		
<u>TEST HOLE 3</u>		
0 - 6"		FOREST DUFF AND TOPSOIL
6" - 42"	SM	BROWN SILTY SAND WITH GRAVEL (LOOSE, MOIST)
GRADES TO GRAY AND MEDIUM DENSE AT 24 INCHES		
GRADES TO DENSE AT 42 INCHES		
TEST HOLE COMPLETED AT 42 INCHES ON 4/27/89		
OCCASIONAL ROOTS TO 18 INCHES		
NO FREE GROUND WATER OBSERVED		

GEI 68-88

EXHIBIT C

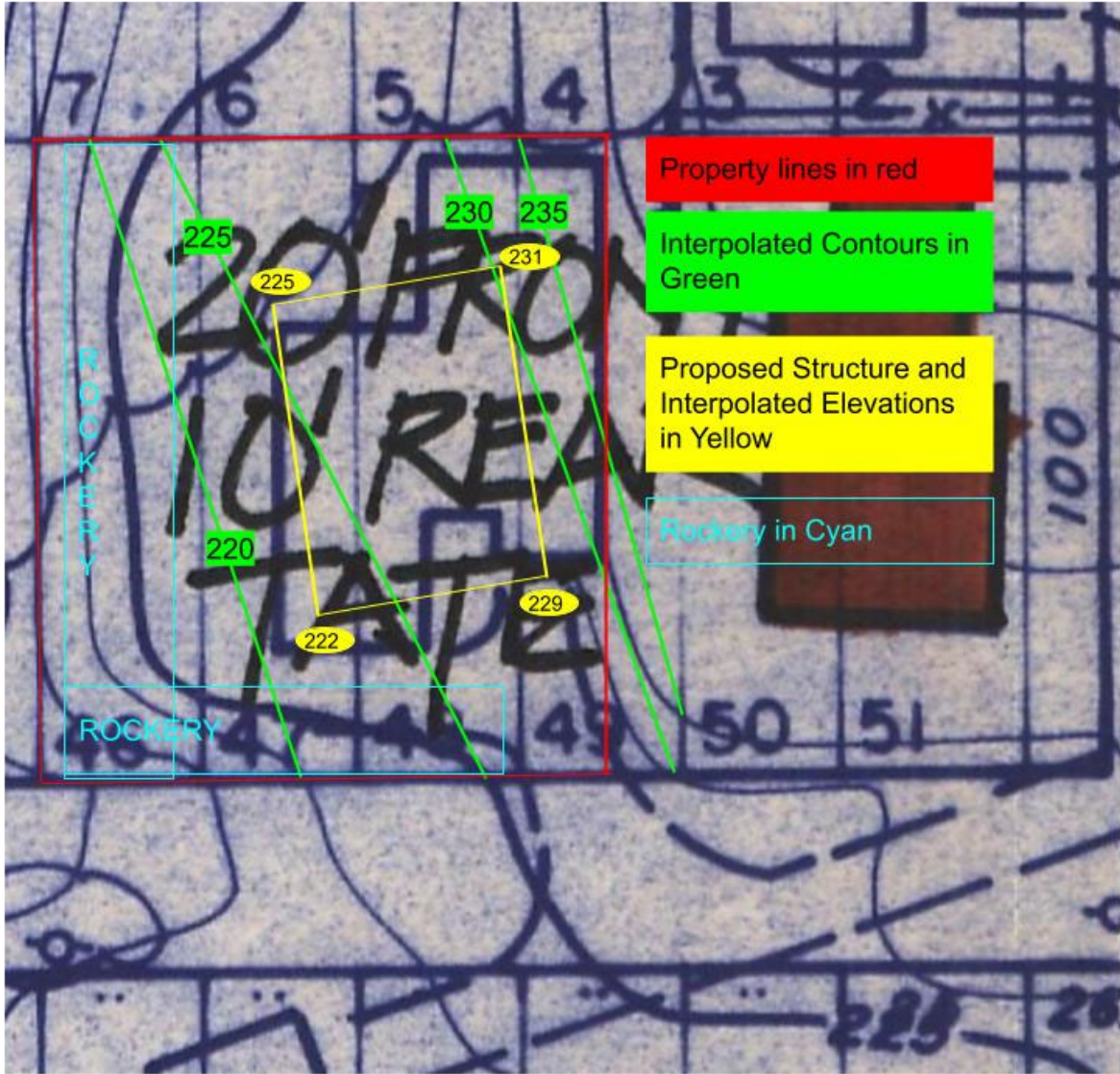
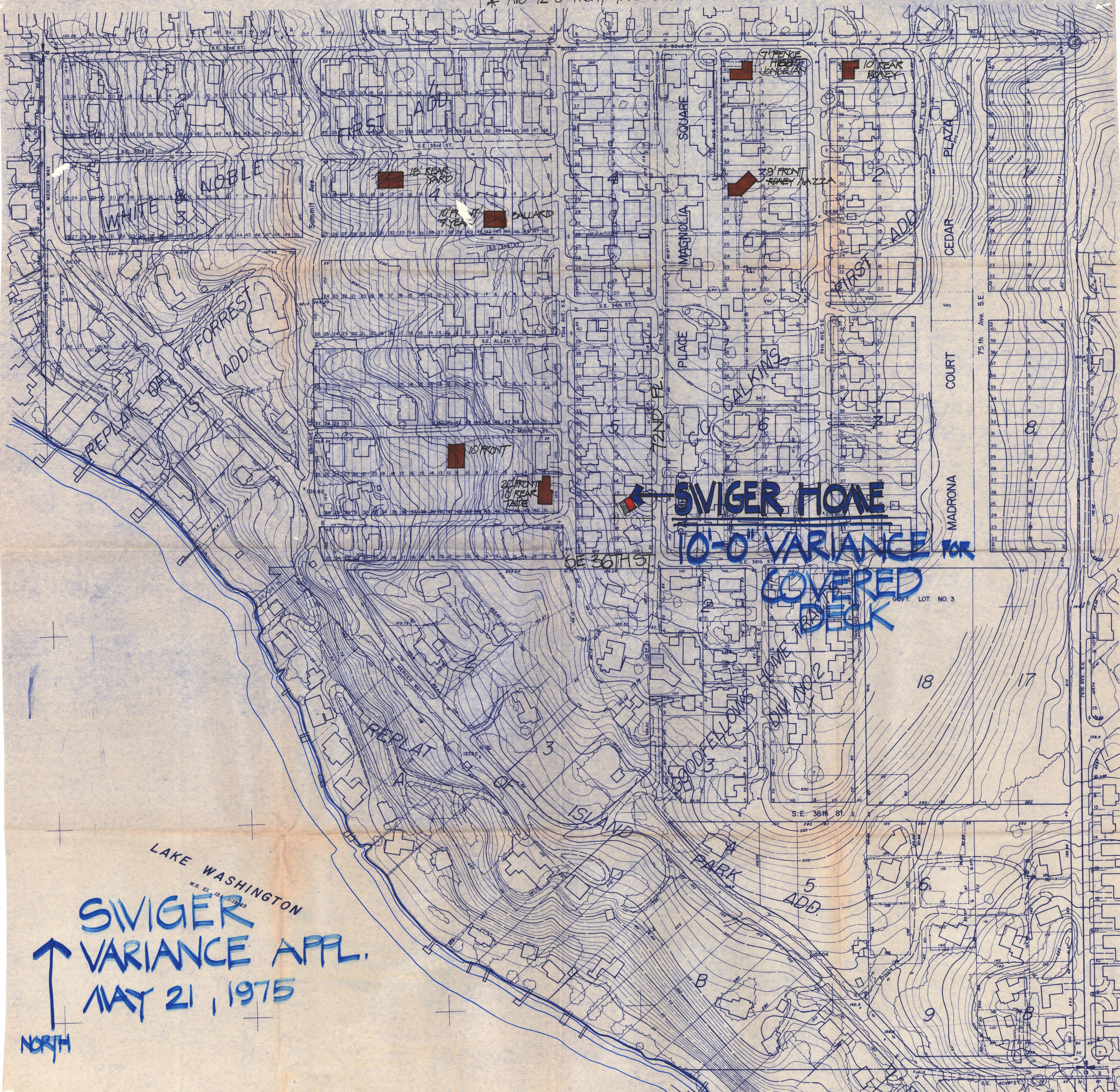

EXHIBIT D

* TWO 12'-0" FRONT YARD VARIANCES



LAKE WASHINGTON
W.S. 151 1-1963

↑
SWIGER
VARIANCE APPL.
MAY 21, 1975

NORTH

SWIGER HOME
10'-0" VARIANCE
COVERED DECK

18' REAR YARD

10' REAR YARD

10' FRONT

20' FRONT
10' REAR
TADE

7' FENCE
HEBER
LONGER

10' REAR
RONEY

20' FRONT
RONEY MAZZA

15' FRONT
ADD

SE 36TH ST

S.E. 38th ST

75th Ave. S.E.

18

17

5
ADD

9

8

7

10

11

12

13

14

15

16

17

18

19

20

21

22

23

24

25

26

27

28

29

30

31

32

33

34

35

36

37

38

39

40

41

42

43

44

45

46

47

48

49

50

51

52

53

54

55

56

57

58

59

60

61

62

63

64

65

66

67

68

69

70

71

72

73

74

75

76

77

78

79

80

81

82

83

84

85

86

87

88

89

90

91

92

93

94

95

96

97

98

99

100

101

102

103

104

105

106

107

108

109

110

111

112

113

114

115

116

117

118

119

120

121

122

123

124

125

126

127

128

129

130

131

132

133

134

135

136

137

138

139

140

141

142

143

144

145

146

147

148

149

150

151

152

153

154

155

156

157

158

159

160

161

162

163

164

165

166

167

168

169

170

171

172

173

174

175

176

177

178

179

180

181

182

183

184

185

186

187

188

189

190

191

192

193

194

195

196

197

198

199

200

201

202

203

204

205

206

207

208

209

210

211

212

213

214

215

216

217

218

219

220

221

222

223

224

225

226

227

228

229

230

231

232

233

234

235

236

237

238

239

240

241

242

243

244

245

246

247

248

249

250

251

252

253

254

255

256

257

258

259

260

261

262

263

264

265

266

267

268

269

270

271

272

273

274

275

276

277

278

279

280

281

282

283

284

285

286

287

288

289

290

291

292

293

294

295

296

297

298

299

300

301

302

303

304

305

306

EXHIBIT E

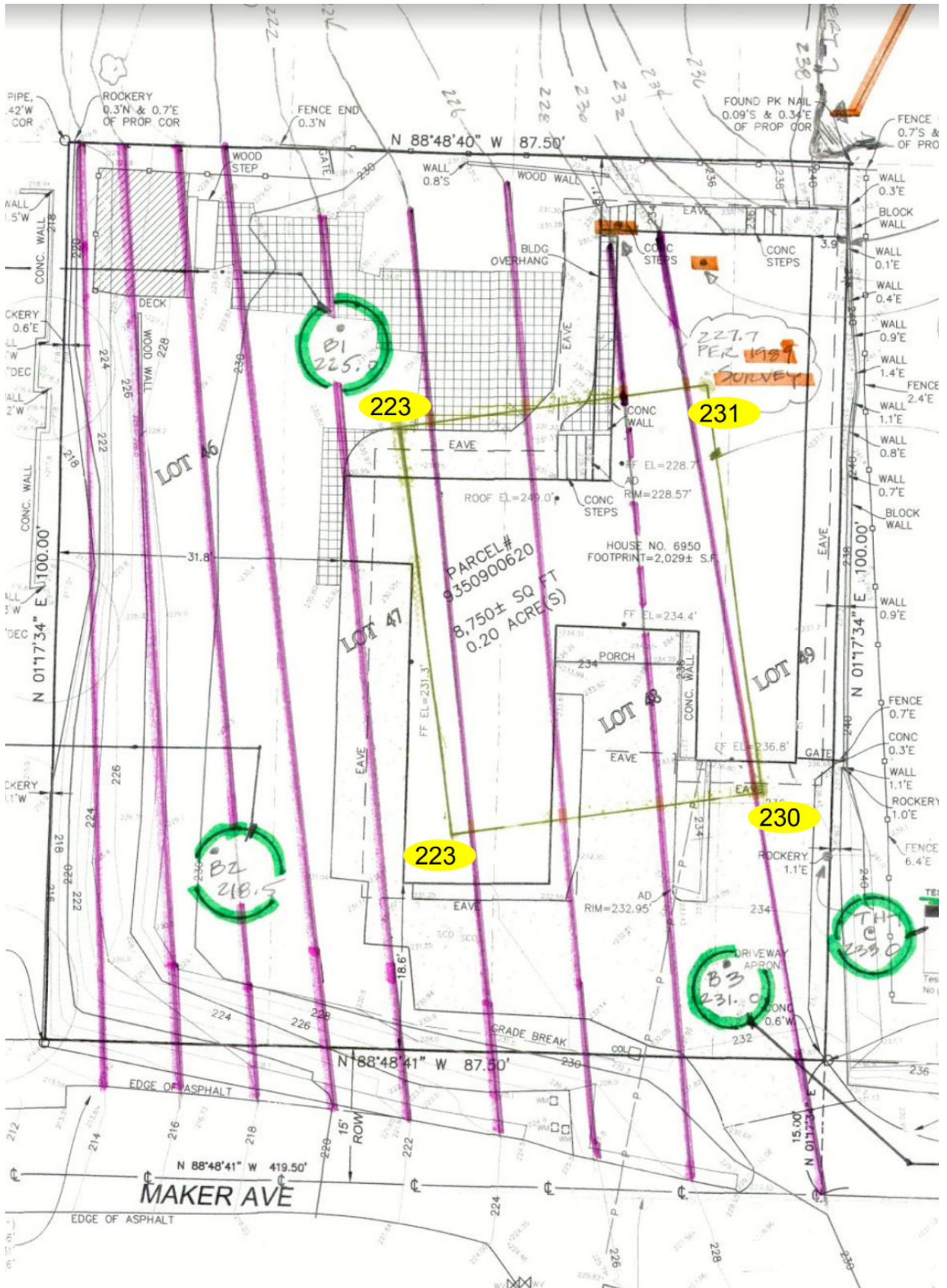

Molly McGuire
Assistant Planner
Community Planning & Development
City of Mercer Island
9611 SE 36th Street
Mercer Island, WA 98040
Molly.McGuire@mercerisland.gov

Comment Letter for Proposed Redevelopment of 6950 SE Maker Street, Permit 2207-019

Dear Ms. McGuire:

My name is Dan Grove and I live at 3515 72nd Ave SE. I'm writing as a concerned neighbor who shares a property boundary with the proposed development (submission documents [here](#)) at 6950 Maker Street ("The Project", owned by The Strand Trust). As a long-time member of the Mercer Island community, I was surprised and dismayed to see a proposal for a house much larger than permitted by code, a house built to a height of 34+' on top of an artificially elevated lot, a house that would be built on a lot with a history of rockery problems and a house whose development was enabled by significantly damaging an exceptional tree. That this proposal was submitted without any discussion with neighbors of the property makes it even more troubling.

While Ms. Strand should be permitted to develop her property, that development must not be permitted where the proposal runs afoul of local law. Doing so would be unfair to the owners of the neighboring properties and potentially damaging to the area.

In this letter, I will lay out a set of issues with The Project. I believe the applicant's representation contains significant factual errors and contravenes several local rules and regulations, which amount to multiple violations of the Mercer Island City Code ("MICC"). A letter from my attorney, Zachary Davison, will detail the specific code violations arising in connection with these issues.

First, the proposal does not recognize the history of its building site, and in doing so, it calculates building height in ways that are incompatible with the MICC. As a result, The Project is larger and higher than allowed.

Second, The Project represents multiple safety risks; its proposal fails to comply with the constraints of its own geotechnical survey and ignores risks of building on a Critical Area during the wettest, riskiest time of the year.

In sum, The Project's plans improperly and unfairly propose building a structure that ignores the MICC and poses risks of significant danger to surrounding properties, in contravention of the reasonable expectations of the affected neighbors.

1. The Proposal Ignores the History of its Building Site

The applicant's development proposal fails to comply with the MICC due to multiple and compounding errors which, if unaddressed, would improperly expand Ms. Strand's ability to build and negatively impact those around her.

A. The Proposal Incorrectly Computes Existing Grade

As an initial matter, the applicant's plans are all premised on faulty computation of the Existing Grade. The property is built atop an artificial grade created by "human-induced action" which "impact[ed] the existing condition of the area" and thus constitutes "Alteration" as defined in [MICC 19.16](#).¹ Using the current condition of 6950 erroneously provides a much higher elevation than its code-defined Existing Grade.

¹ Per definitions set out under [MICC 19.16](#). I discuss these definitions in further detail below.



Figure 1: Retaining Wall between 6950 SE Maker Street and SE Maker Street

Fig. 1 drives this point home: it shows a photo of the current house at 6950 Maker, relative to the SE Maker Street roadway, with elevations indicated. The road sits at 223' at this point (as shown), while the current house is at 231.3'. The Project's plans incorrectly substitute the current grade for the code-defined Existing Grade, which results in an impermissible net gain of approximately 8'.

Second, there is incontrovertible evidence that the Existing Grade has undergone Alteration. This evidence includes, and is not limited to, (i) the applicant's own geotech survey and (ii) the rockeries built along a majority of the property's perimeters to contain the extensive fill used throughout the property. The geotech survey attests to fill in all three of the boreholes tested on the property. Indeed, the southwest borehole contained 12', thus artificially elevating the lot by 12' at that point. The borehole data overall make it inarguable that the current grade on the property is artificially elevated.

The rockeries create a uniform level across their highest point. Their lowest point varies across the property and provides accurate visual evidence of changes in the Existing Grade. In some areas, the rockeries are up to 15' high. Additional survey data confirm

that their height is relative to the Existing Grade. According to prior residents, the rockeries have been here since the house was constructed in the 1950s.

Third, an analysis of cross sections taken through and around The Project shows the degree of artificial elevation. Figure 2A shows 4 east-west cross sections through The Project whose elevation we can measure based on either the known Existing Grade at the lot's boundaries or based on data from The Project's proposal. The colors of each line match the colors in Figure 2B, which shows the elevation as one travels along each line, east to west.

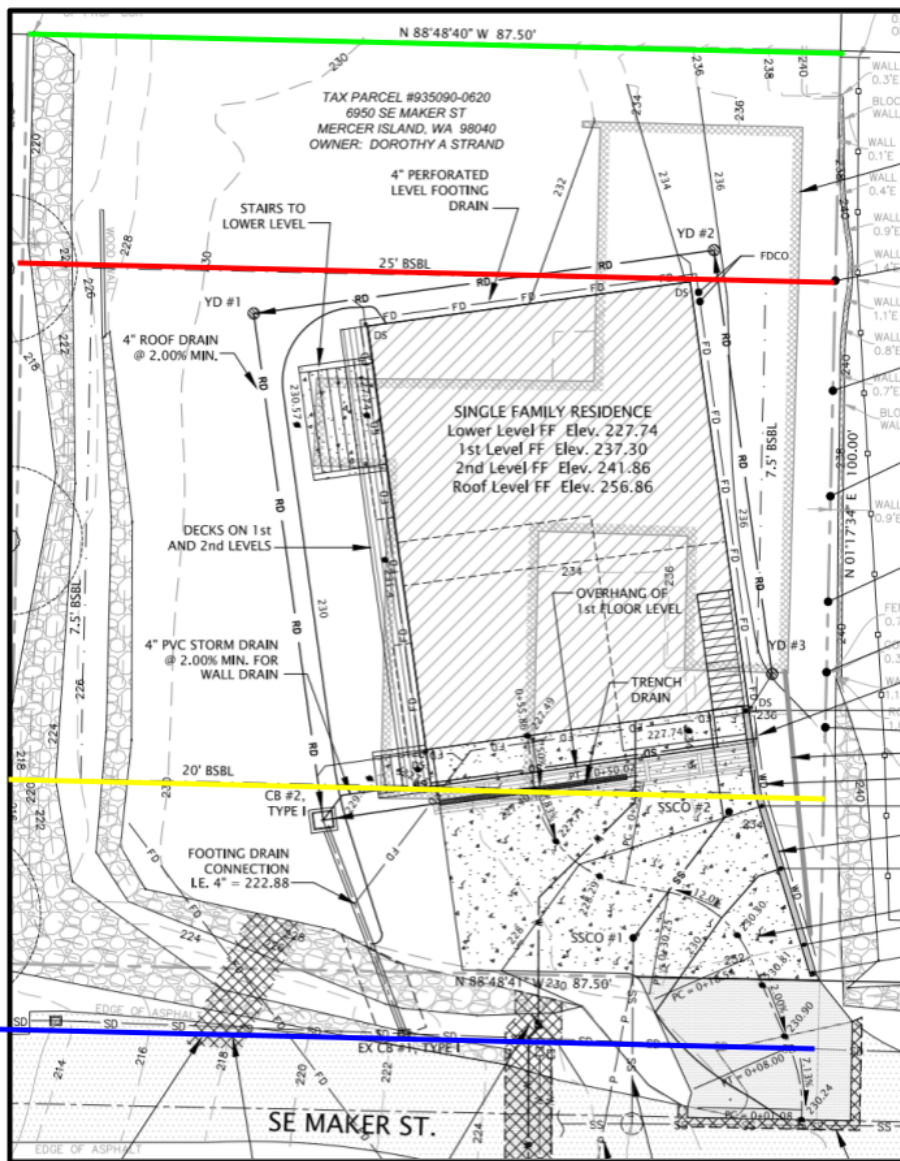

Figure 2A: Locations of the contour slices in Figure 2B

S Boundary, N House Cross Section, S House Cross Section and N Boundary Elevations

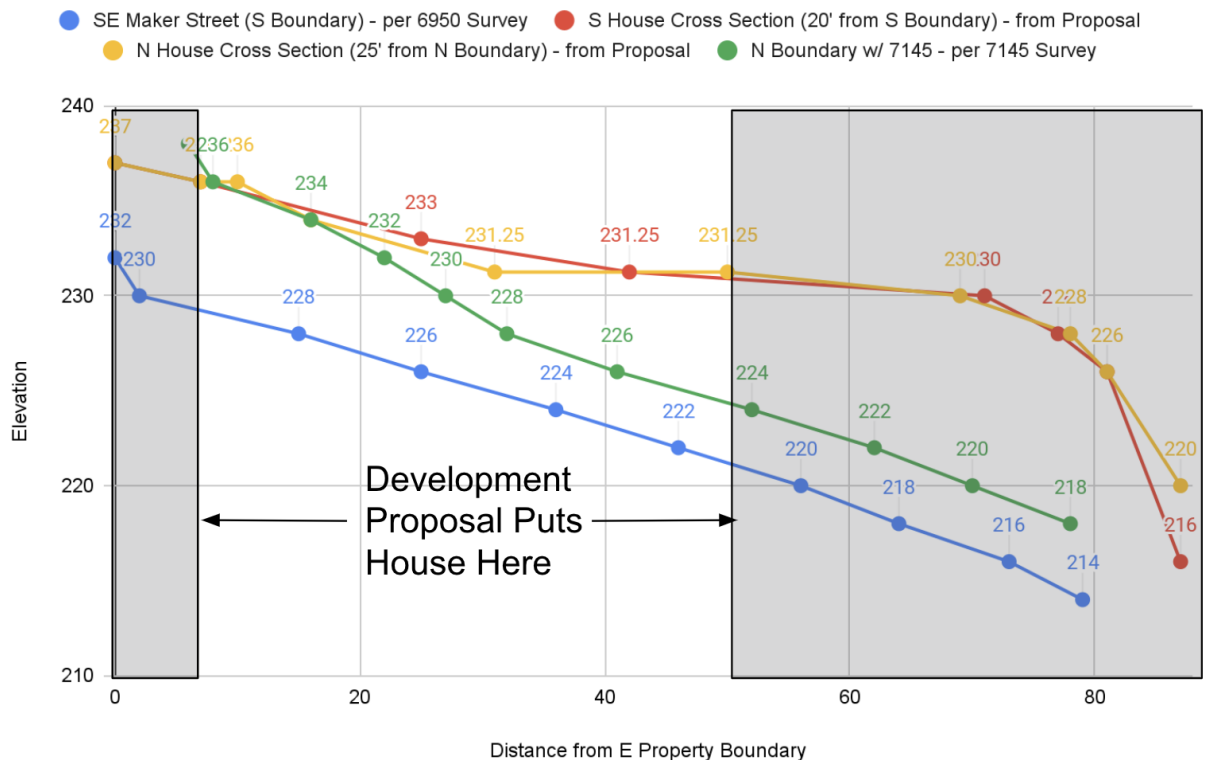

Figure 2B: Current Elevations from East Property Boundary to West Boundary

Figure 2B shows that the cross sections corresponding to The Project's building location (in yellow and red) have been significantly artificially elevated (by as much as 10'). The photo in Figure 1 matches the lines in blue (showing the SE Maker Existing Grade) and yellow (showing the proposed Existing Grade on an east-west line 20' from SE Maker) in Figure 2B at 42' from the E property boundary. Please see Dr. Elisabeth Green's comments on the elevation data from a professional geologist's perspective (submitted independently).

The MICC and Mercer Island's Administrative Interpretations are clear on how to determine a property's Existing Grade. "Existing Grade" is a legally defined term in the MICC and must be understood apart from "Alteration" (another legally defined term) that may have affected the present condition of the property. Per MICC, a property's Existing Grade may not be changed through Alteration. This is clear from these Definitions in [MICC 19.16](#):

Existing grade: The surface level at any point on the lot prior to alteration of the ground surface.

Alteration: Any human-induced action which impacts the existing condition of the area, including but not limited to grading, filling, dredging, draining, channeling and paving (including construction and application of gravel). "Alteration" does not include walking, passive recreation, fishing, or similar activities.

A development proposal may not use graded, filled, or paved elevations as Existing Grade. Yet this development proposal attempts to do just that.

Consequently, the applicant incorrectly computes the Average Building Elevation² ("ABE") as 233.06.' My data offers multiple forms of evidence that the correct ABE is approximately 226.7'.

B. Approximate Topographic Elevations Can Be Used to Determine Existing Grade

Identifying the Existing Grade is difficult on an artificially elevated property like this one. In order to identify 6950 Maker's Existing Grade, it must be computed independently of Alteration. Ideally, Existing Grade is computed via a survey of the property prior to any Alteration. Administrative rulings show that Mercer Island may relax this requirement in cases in which it isn't possible to determine the surface level of the points on the lot prior to Alteration of the ground surface.

However, this is not the case here; it *is* possible to determine the surface level of the points on the lot prior to Alteration. While it is true that 6950 SE Maker Street was developed in the 1950's, and there are no pre-development topographic surveys of the lot, an alternative method is permitted. In cases in which the property lacks pre-development topographic surveys, local rulings permit interpolation of "approximate

² Per definitions set out under [MICC 19.16](#)

Average building elevation: The reference point on the surface topography of a lot from which building height is measured. The elevation in the R-8.4, R-9.6, R-12, and R-15 zoning designations is established by averaging the elevation at existing grade or finished grade, whichever is lower.

Formula: Average Building Elevation = (Weighted Sum of the Mid-point Elevations) ÷ (Total Length of Wall Segments)

Where:

Weighted Sum of the Mid-point Elevations = The sum of: ((Mid-point Elevation of Each Individual Wall Segment) × (Length of Each Individual Wall Segment))

topographic elevations” as a proxy. Mercer Island Administrative Ruling [12-04](#) discusses this scenario in Finding 6:

[Finding] 6. Portions of a property typically remain undeveloped during single family residential construction, and therefore, are likely to retain the contour present before the most recent development. While it may be impossible to establish grade prior to all lot alterations, it is feasible to interpolate the approximate topographic elevations of the lot previous to the most recent development.

Through careful research, we were able to develop clear topographic information about the Existing Grade of the north and south boundaries of The Project. This information, drawn from the sources enumerated below, makes it possible to “interpolate the approximate topographic elevations of the lot previous to the most recent development” (as per Administrative Ruling 12-04). These sources are:

1. **A pre-development survey** (found [here](#)) dated May 1989, of 7145 SE 35th Street, which is the property immediately to the north of 6950 Maker.
2. **The Project’s own Survey**, which shows the grade of SE Maker Street, immediately south of 6950; and
3. **Contemporary and historic survey data**, which show that the grade of SE Maker Street has not changed since 6950 was initially developed.

Presenting each of these in turn:

1. **The pre-development survey of 7145 SE 35th Street (the “7145 Survey”)** provides detailed and compelling evidence of the original lot conditions immediately north of the 6950 house. This survey includes the basement of 6950, and the Existing Grade immediately adjacent to the present 6950 house. The survey shows several large trees across the 7145 property, and close to the site of the current 6950 house. These mature trees help to date the topography of 7145 to earlier than the development of 6950 (the photo in Appendix B offers further proof), and offer contour lines for establishing approximate topographic elevations. In addition, the [7145 SE 35th Geotech Study](#) (also carried out in 1989) provides specific insights into three boreholes north of 6950 (see the bottom of page 3 of the geotech study). These boreholes show a natural forest floor with no fill underneath. **In conclusion: triangulating these data points helps establish the correct “approximate topographic elevations” of the north side of 6950.**

2. **The Project's own survey** enables further triangulation of the 7145 Survey data. The 6950 basement's Finished Floor ("FF") is represented in both surveys and provides a common point of reference. The [Project's survey](#) from 2022 (page 2) represents the elevation of 6950 basement's FF at **228.7'**. The 7145 Survey from 1989 lists the FF at **227.6'** (as shown in Figure 3. The fairly small difference in the two elevations can be attributed to changed techniques for measuring elevation in the intervening years). **In conclusion: using the 6950 basement as a common reference point makes it possible to establish the original contours on the north side of 6950 relative to the basement.**

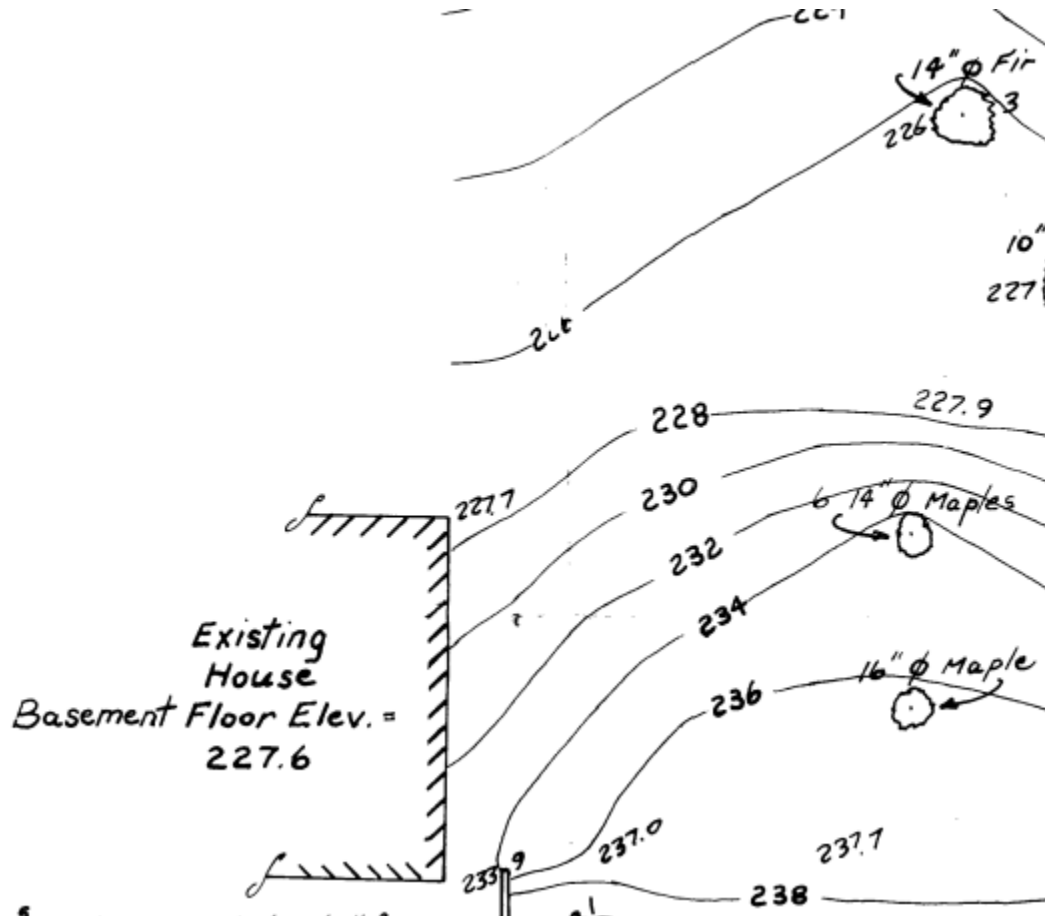

Figure 3: Image from Survey of 7145 SE 35th. 6950 Basement is on the left, North is to the right. Note that the contours go all the way to the house walls of 6950.

3. Contemporary and history survey data

To verify the relationship of the two surveys above, I located a pre-1961 survey ("1961 Survey") which includes both the Existing Grade of the 7145 property north of 6950 and of SE Maker Street as it stood prior to 1961. As shown in

Appendix B, there is compelling evidence that the Existing Grade when 6950 was initially developed in the mid-1950's matches the grade of the street as surveyed in 2021. All 3 surveys (7145, 1961, and the current project survey) provide nearly identical views of the Existing Grade of the north and south boundaries of The Project. **In conclusion: with this data in hand, it is possible to interpolate the approximate topographic elevations of 6950 prior to development, as shown in Figure 4.**

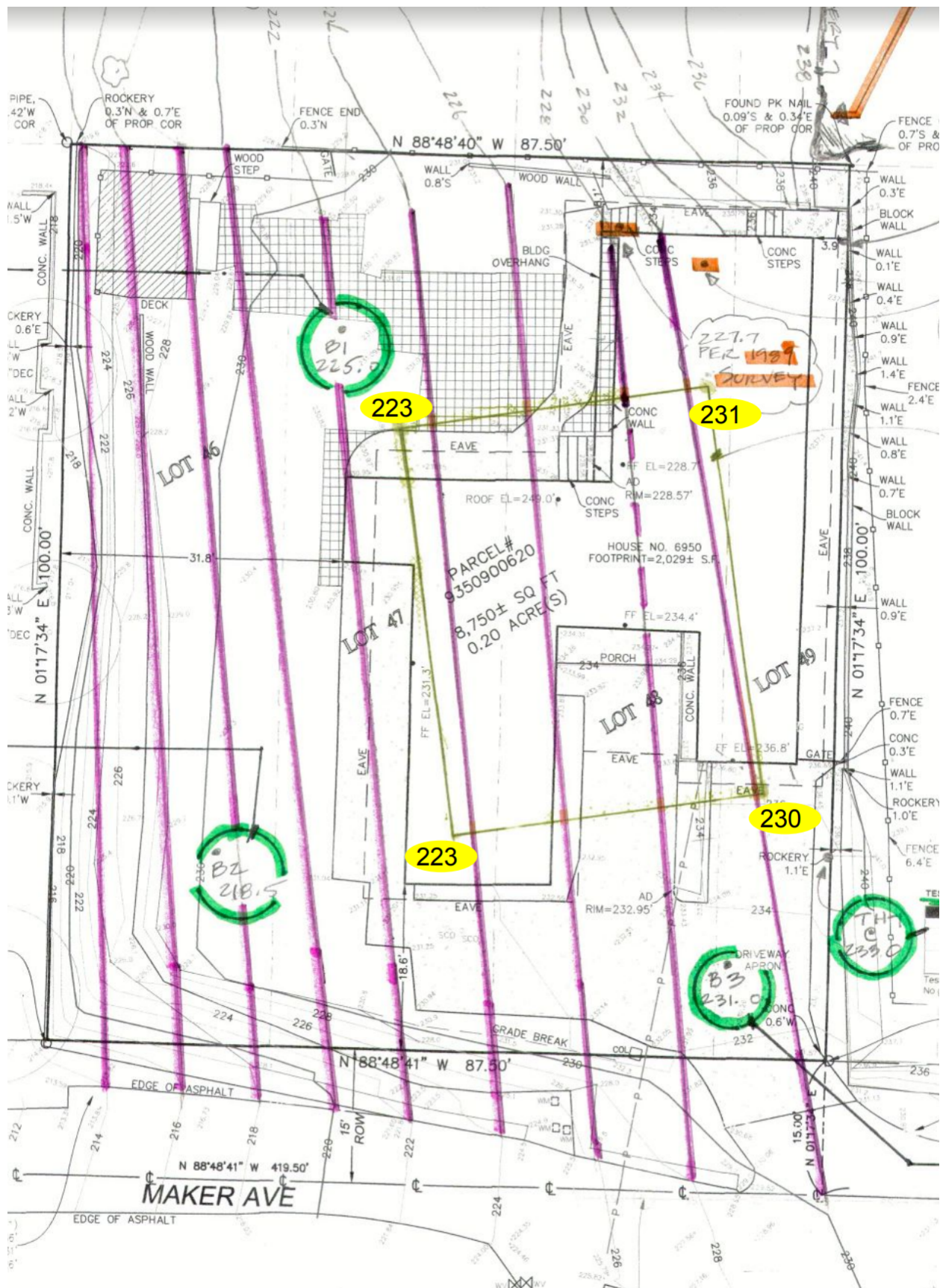

Figure 4 - Interpolating Approximate Topographic Elevations of the Project based on the 7145 Survey for the Northern Boundary and the current 6950 survey for SE Maker Street. Details on how Jim Mattison and I created this can be found in Appendix C.

In Figure 4 above, The Project's outline is shown in yellow, and interpolated elevations are shown in yellow ovals at each corner.

The interpolated grades make sense in the context of the lot's surroundings. It is clear to the eye that the slope around The Project drops primarily from East to West, and secondarily from North to South. We would expect to see contours dropping in elevation as one moves from NE to SW, which is exactly the scenario in these interpolated contours.

In order to try to verify this set of findings, I interpolated contours from the edges of the 6950 property onto the 1961 Survey, as shown in Figure 5 (these contours are at 5' intervals because that was the resolution of the 1961 Survey). I then placed The Project over these interpolated contours. The result is shown below, including The Project and the Existing Elevations of its corners in yellow.

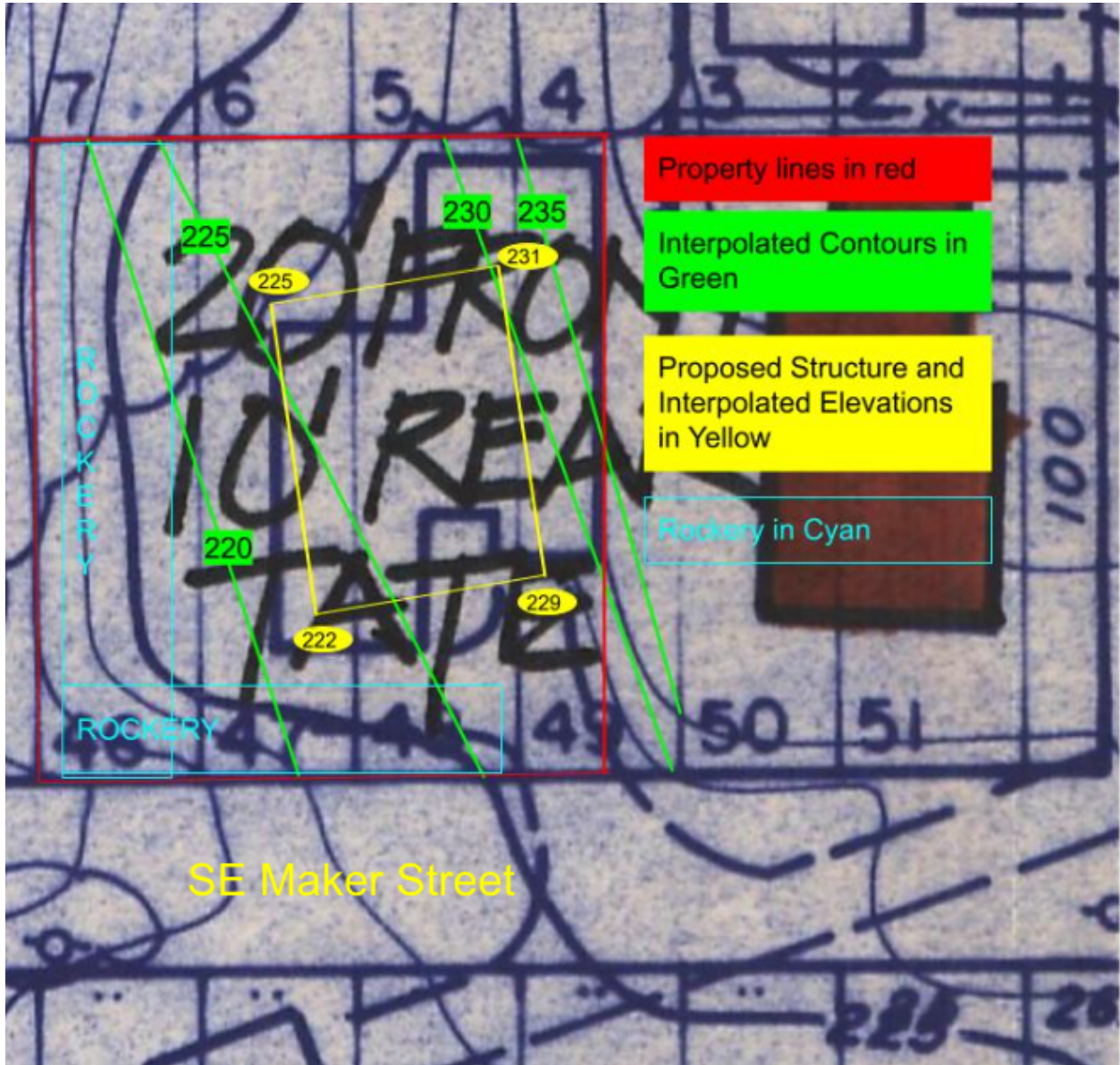

Figure 5: Interpolating Approximate Topographic Elevations of The Project based on the 1961 Survey

A comparison of The Project's building corners when overlaid onto these two interpolated contours (from the 7145 Survey and the 1961 Survey) shows remarkable consistency. In turn, this consistency attests to the alignment of these two surveys—independently conducted, decades apart, by different parties—and thus underscores the reliability of both surveys.

Corner of The Project	7145 Survey	1961 Survey	Difference between surveys for this corner
NW	223'	225'	-2.0'
NE	231'	231'	0.0'
SE	230'	229'	+1.0'
SW	223'	222	+1.0'

With this data, I computed the average original elevation of The Project:

- The 1961 Survey shows the average original elevation as 226.6'
- The 7145 Survey shows the average original elevation as 226.75'

Average original elevations computed from these two surveys differ by just 0.15'. In other words, two totally independent surveys yield building elevations that are almost identical.

Combining the 7145 Survey and the 6950 Survey offers more reliable evidence for determining Existing Grade than the 1961 survey alone because they both possess significantly higher resolution than the 1961 Survey. After careful study, I believe that a combination of the 7145 Survey and the 6950 Survey offers the most reliable basis for computing elevations for The Project going forward.

By using current grade as a shortcut, rather than correctly computed Existing Grade, The Project's proposal reflects a series of violations of MICC. My attorney, Zachary Davison, describes these in detail in his letter:

- Because Average Building Elevation is computed incorrectly, The Project exceeds the maximum building height by more than 4'.
- Because Existing Grade is computed incorrectly, The Project exceeds the Maximum Building Height on a Downhill Slope by more than 8'.
- Because The Project's Gross Floor Area ("GFA") incorrectly excludes the entire basement (indeed, the entire lower level), The Project exceeds its maximum GFA by more than 1200 square feet (beyond the 3500 square feet allowed).

2. The Critical Slope on 6950's Lot Is Not Safely Addressed by The Project

In addition to the significant errors with respect to the existing elevation and allowed square footage, the Development Proposal contains potentially significant safety risks.

The Applicant's [geotech report](#) is premised on construction that remains within the footprint of the existing house.

“Buffers and Mitigation: Under MICC 19.07.160(C), a prescriptive buffer of 25 feet is indicated from all sides of a shallow landslide-hazard area. The recommendations presented in this report are intended to protect the planned construction, which will be located **within the footprint of the existing house** (*emphasis added*), which is set back approximately 20 feet from the top of the rockery that defines the top of the steep slope along the western perimeter of the property.”

Despite this clear limitation, The Project is **not** located within the footprint of the existing house. At least 10 percent of its area (roughly 150 square feet of the northwest portion of the proposed structure) sits outside the footprint of the current structure.

The Project does not heed the geotechnical survey's guidance.

While it is possible to reduce Mercer Island's 25' prescriptive buffer, doing so always requires care. The Project is set back only 20' from the top of the western rockery. The geotech report says that this can be mitigated. However, there is a history of problems with this very large and far from code-compliant rockery (see Figure 6 below). The house at 7030 SE Maker Street is immediately below the rockery (less than six feet away), and is at risk from changes proposed by The Project. In light of these circumstances, The Project's failure to work within the scope of the geotech's recommendations and report is deeply troubling.

CITY OF MERCER ISLAND
 3505 88TH AVE SE
 MERCER ISL, WA. 98040



Oct 14, 1981
 RECEIVED
 OCT 16 1981

Attn: Mr. Edward Wilczak
 Subject: Trees remaining on building site
 on Maker Street.

Gentlemen:

As you know, the week of Oct. 5, 1981 we experienced a torrential downpour. This fact, compounded by subject excavation caused a portion of my rocky retaining wall to wash out. The excavation is adjacent to and due West of my house. The builder, Bill Zelund and I came to a mutual understanding for the repair of my rockery.

The problem that generated this letter, however, is not the rock wall but rather the huge maple trees remaining on the Bill Zelund lot. They pose a serious problem, i.e., they endanger the safety of my family and my house. In a severe wind we sometimes find large limbs broken off and lying in our yard. Now, with the excavation of

the soil adjacent to the roots of these immense maple trees the hazard is substantially increased. Bill Island has advised me the City of Mercer Island will not permit removal of these trees I appase this position and wish you to reconsider — to re-evaluate this situation. I respectfully request that you grant permission to Bill Island to remove the trees before his house is erected at which time any tree removal expense would be substantially increased.

Sincerely,
Douglas Allen

DOUGLAS G. ALLEN
6950 SE MAKER ST.
MERCER ISL, WA. 98040

PHONE: HOME 232-5445
BUS. 237-3470

RECEIVED
OCT 16 1981

Figure 6: Letter (dated 1981) describing the 6950 rockery washing out under heavy rain

In addition, the geotech survey expresses concerns about disturbing the rock wall between 6950 and my house, 3515 72nd Ave SE. Per the geotech survey:

“[T]o prevent the excavation for the proposed residence from **undermining the neighboring retaining wall and rockery**, no un-shoring excavation should extend below the existing grade along the east side of the site. It may be feasible to use the existing eastern basement foundation wall for temporary shoring; however, we anticipate the existing wall will require structural bracing. This will need to be evaluated and designed by the project structural engineer. Alternatively, temporary shoring in the form of cantilevered soldier piles will be required along the eastern perimeter of the proposed excavation” (my emphasis).

Yet, the Applicant presents no mitigation plan to address these concerns. As the affected owner of “the neighboring retaining wall and rockery” mentioned in the report quoted above, I have significant concerns about the risks posed by the proposed development.

I request that the City of Mercer Island require an approved shoring plan for the eastern side of this project prior to any demolition of the existing structure. In addition, given the risks outlined, the Applicant should be required to hire a geotech engineer for a new survey tailored to her actual building aspirations (beyond the current house’s existing footprint) as well as for regular inspections of the eastern side of the site.

As I understand it, the applicant proposes to begin demolition, excavation, and construction starting in mid-November 2022. It is not news that this is the start of a very rainy 6-8 months in Seattle. Given the numerous code violations and safety risks, I hope The Project will not launch during this riskiest time of the year for construction. If this is permitted to go forward in that time frame, the City should require both indemnification and a performance bond, as allowed under MICC 19.07.160(F)2.b.

In addition, I request that the city perform an independent geotechnical evaluation of the site prior to any work taking place.

Overall, both the geotech study and prior data show that The Project is taking place in a risky location with large amounts of landfill and evidence of problems in the past. The Project does not adhere to the geotech report from 2022, and it poses foreseeable risks of damage and danger to the properties around it. Under these circumstances, the Applicant’s apparent choice to ignore the history of the site raises significant concerns.

3. The Project was Enabled by Damaging and Endangering an Exceptional Tree

As the letter from Mr. Davison shows, this project was enabled by unpermitted cutting of the Exceptional Tree that grows in my backyard. The presence of this Exceptional Tree would have limited the scope of The Project, because its branches and trunks would have prevented the construction of an excessively high building, such as The Project. MICC would not allow the removal of an Exceptional Tree unless the tree's presence limited the constructable gross floor area to less than 85% of the maximum GFA allowed. MICC 19.02. Had Ms. Strand followed the proper procedures, she would have been unable to both build 100% of the GFA and engage in cutting an Exceptional Tree. The Applicant should not benefit from Ms. Strand's having engaged in prohibited tree removal activities. It would seem only fair, in consequence, to limit The Project to 85% of the maximum GFA permitted (85% of 3500 square feet is 2975 square feet).

Figure 7A below shows how this Exceptional Tree would have limited the construction of The Project as proposed.



Figures 7A and 7B: Exceptional Tree before and after unpermitted cutting

Conclusion

I have approached this comment period with an engineer's sensibilities and the concerns of a good neighbor. I have lived on Mercer Island with my family for 17 years and feel deep reverence for and dedication to the community, including for its beautiful landscaping and mature trees. In addition, when I purchased this home, I did so fully aware that the MICC imposed certain reasonable restrictions on maximum building height and tree removal. I urge the Mercer Island Community Planning and Development Department to honor these reliance interests and to protect the spirit and the letter of the laws which help to maintain a sense of uniqueness and tranquility on the Island.

Thank you for your attention to all of these challenging and important issues. Should you have any questions, please feel free to contact me at dan@grove.cx.

Dan Grove
3515 72nd Ave SE

Appendix A - Data Sources (In reverse chronological order)

- [6950 Geotechnical Survey](#) - dated 2022.
- [6950 Survey](#) - dated 2021. On page 2, provides Existing Grade of SE Maker St.
- [6933 SE 35th Street Survey](#) - dated 2001, correlates Existing Grade of 7030 and 7145. 6933 is immediately north of 7030 SE Maker, and immediately west of 7145.
- [7145 Survey](#) - dated 1989, provides Existing Grade north of 6950.
- [7145 Geotechnical Survey](#) - dated 1989.
- [Letter about failure of 6950 western rockery](#) - dated 1981.
- [7030 SE Maker Street Survey](#) - dated 1981, provides Existing Grade immediately west of 6950.
- [1961 Survey](#) - predates July 1961 (date based on this July 1961 [service request](#) for a house which is not present in the survey).

Appendix B - Evidence that the 2021 survey of SE Maker Street represents the Existing Grade of Maker Street when 6950 was initially developed

An old (undated, but almost certainly 1946 based on the letter below) aerial photo was submitted as part of a vacation application for a portion of SE Maker Street. It proves that the SE Maker gravel road predates the development of 6950.

The [photo source](#) is Mercer Island GIS documents for 7020 SE Maker Street.

[Mercer Island Resolution 237](#) in 1965 allowed the extension of the asphalt roadway on SE Maker west past Lot 5. This matches exactly the survey in 1961, which shows a driveway going from Lot 5 to the East.

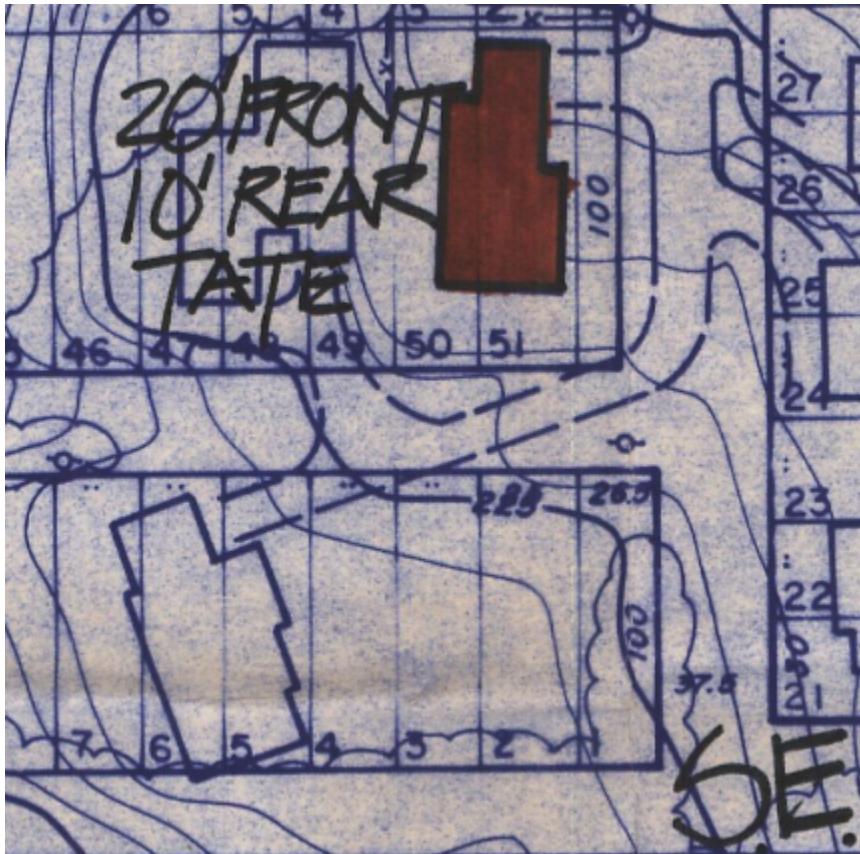

When the boundary lines of the properties from the current GIS are laid onto photo (possible because the 7020 [labeled “Wilson”] property matches 7020’s lot lines today. The West Mercer Way roadway in the photo matches its current GIS data), two things

become immediately clear:

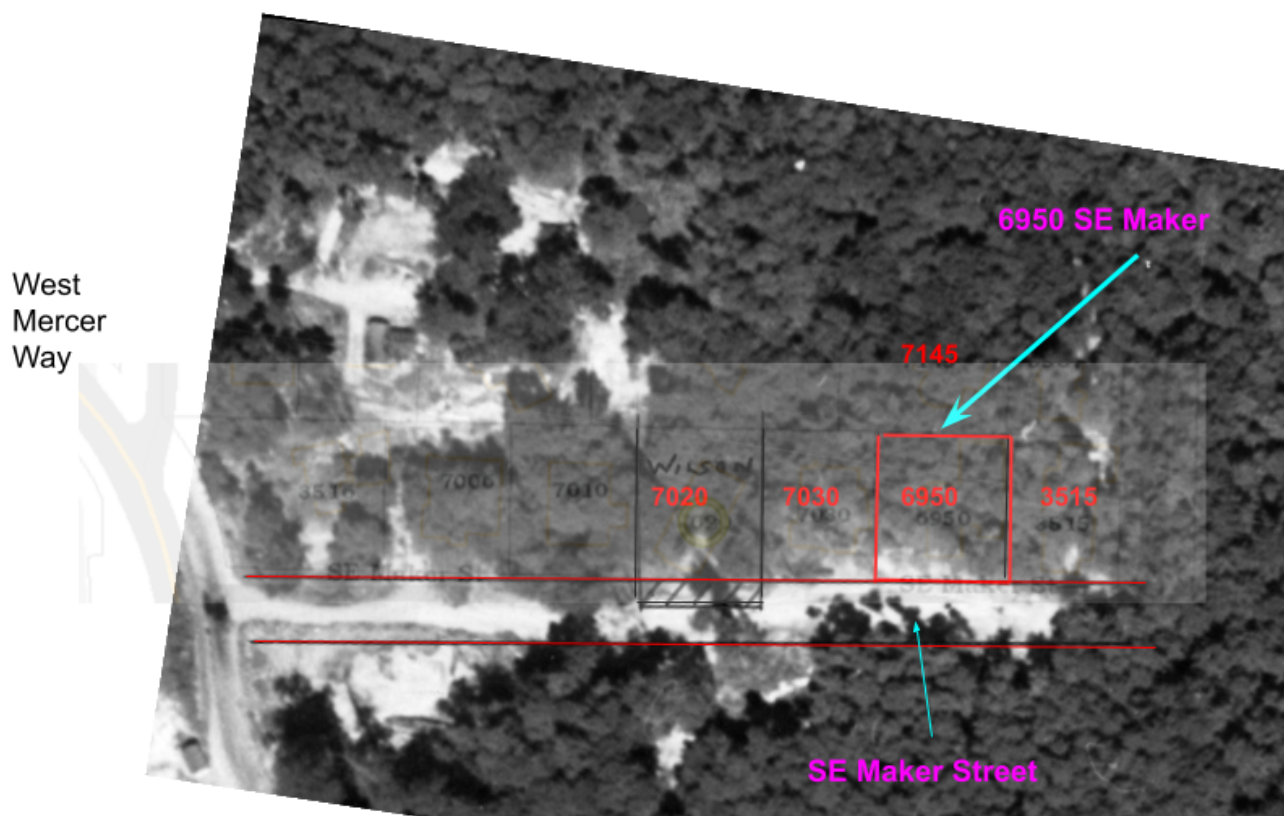

Figure 7: Photographic evidence that the gravel road shown in the 1961 survey was present prior to development of 6950.

- The gravel SE Maker Street shown in the 1961 survey was present prior to development of 6950.
- The photo shows the original condition of the lot of 6950, which differs drastically from its condition today.

Additionally, [this letter](#) (also from the 7020 GIS documents) shows that SE Maker Street was in place between 69th Ave SE and 72nd Ave SE no later than 1946.

The 2021 survey of 6950 included SE Maker Street, and closely matches the Existing Grade of SE Maker Street prior to 6950's development. The evidence for this is as follows:

- SE Maker Street was a gravel road that was first paved no earlier than 1963, according to Mercer Island Public Works. Figure 7 shows this road.

- The 1961 survey is no newer than mid-1961, because it shows a vacant lot at 3421 72nd Ave SE. By mid-1961, there was a residence at this address (as shown by [sewer records](#)).
- Therefore, the road shown on the 1961 survey is the original gravel road (which is backed up by the survey showing the road going all the way to West Mercer Way). The paved road never extended to the west past the current 7030 SE Maker Street.
- This means that the gravel road was the Existing Grade at 6950's boundary at the time of development.
- We can then correlate the 1961 survey's elevations with elevations from Mercer Island's LIDAR data. The 1961 survey shows an elevation of 307.60' in the intersection of 32nd Street SE and 72nd Ave SE.
- Current Mercer Island LIDAR data from the Mercer Island GIS shows this intersection at approximately 310', or ~2-3 feet higher than the 1961 survey. This LIDAR data precisely matches the 2021 survey.
- If we shift the 1961 survey of SE Maker Street up 2.5' (as shown below), there is a nearly perfect match to the 2022 survey of SE Maker Street.
- The "+"s in the illustration below are the result of moving the 1961 survey's contours to match this elevation difference. As is clear, the grade of the gravel road is nearly identical to the grade of the roadway today. This provides compelling evidence that the current surface of SE Maker Street matches the existing grade of the street when 6950 was initially developed.



Elevations from 1961 Survey increased by 2.5' to match 72nd & 32nd Monument difference

Appendix C - Creation of Interpolated Contour Lines in Figure 4

To create Figure 4, Jim Mattison and I used several pieces of data:

- Contours of SE Maker Street from the 6950 Survey. As we have shown, these contours represent the Existing Grade of SE Maker Street.
- Contours on the north boundary of 6950 from the 7145 Survey. As we have shown, these contours represent the Existing Grade of that boundary line.
- Bore- and Test-hole data from the 6950 Geotech study, showing us how deeply artificial fill was found at various points on the 6950 property.

In order to match the 6950 basement FF elevations between the 6950 Survey and the 7145 Survey, we shifted the 7145 contours by 1 vertical foot (in other words, a contour listed at 228' on the 7145 Survey was moved to 229' in Figure 4).

We also show test and borehole data in green circles in Figure 4 - these boreholes show the maximum elevations of non-fill found in each hole during 6950's geotech survey in 2022. This data matches the interpolated topographic elevations quite well.

EXHIBIT D

Project Information: STRAND RESIDENCE, 6550 MAKER STREET, MERCER ISLAND, WA 98040. Occupancy Type: Single family homes and duplexes. Code Version: WSEC 2018. Classification: Medium Dwelling Unit - 4351 sq. ft.

ANALYSIS SET UP: What code compliance pathway are you using? Table 406.1 UA Table 407. Project Building Type? New Construction. Occupancy Type? Single family homes and duplexes. Code Version? WSEC 2018.

RESULTS - Comparison of Baseline and Proposed Design. Component Performance, R-occupancy. Table with columns for Component, U, Area, UA. Rows for Doors, Overhead Glazing, Vertical Glazing, etc.

Table 406.2 Fuel Normalization Credits. System No., Full Description, Select System Type, Fuel Normalization Credits (406.3), Energy Credits (406.3), Total Credits (406.2 & 406.3).

Table 406.3 Energy Credits. Option No., Category, Select Options, Energy Credits, Brief Description of Selected Options. Rows for Efficient Building Envelope, Air Leakage Control, etc.

THERMAL ENVELOPE DETAILS - Proposed Design. Conditioned Floor Area, Proposed Design: 4,351 sq. ft. Classification: Medium Dwelling Unit.

Exterior Doors. Table with columns for Plan ID, Component Description, Ref, U, Area, UA.

Plan ID, Component Description, Ref, U, Area, UA. Rows for EXEMPT, SIDEWALK, etc.

Overhead Glazing. Table with columns for Plan ID, Component Description, Ref, U, Area, UA.

Vertical Glazing Schedule. Rows to show 16. Table with columns for Plan ID, Component Description, Ref, U, Area, UA.

Floor/Vaulted Ceilings. Table with columns for Plan ID, Component Description, Ref, U, Area, UA.

Walls (Above Grade). Table with columns for Plan ID, Component Description, Ref, U, Area, UA.

Floor (over crawl or exterior). Table with columns for Plan ID, Component Description, Ref, U, Area, UA.

Slab on Grade (less than 2 feet below grade). Table with columns for Plan ID, Component Description, Ref, U, Area, UA.

Below Grade Walls and Slabs. Table with columns for Plan ID, Component Description, Ref, U, Area, UA.

Ventilation Requirements. Number of Bedrooms: 3. Run-Time Percent in Each 4 Hour Segment: 50%. Is the system Balanced? Unbalanced. Ventilation Code Section: IRC Chapter 15. Whole House Mechanical Ventilation Airflow Rate: 222 CFM.

HVAC Thermal Distribution System. Is this a hydronic heating system? No. Location of Radiators: Conditioned Space. Is Duct Testing Required? No.

Links to Download Forms, Checklists and Other Resources. Compliance Certificate: Insulation Certificate for Residential New Construction. Duct Testing Addendum: Existing Construction, New Construction.

Heating System Sizing - Proposed Design. Nearest Weather Station: Death. Indoor Design Temperature: 70 F. Outdoor Design Temperature: 24 F. Design Temperature Difference (delta T): 46 F. Conditioned Floor Area: 4,351 sq. ft. Conditioned Volume: 36,824 cu. ft. HVAC System Type: Heat Pump. Location of HVAC Distribution System: Conditioned Space. Sum of UA, including exempt door and window: 650. Envelope Heat Load: 27,411 Btu / Hour. Air Leakage Heat Load: 19,173 Btu / Hour. Building Design Heat Load: 45,783 Btu / Hour. Building and Duct Heat Load: 45,783 Btu / Hour. Maximum Heat Equipment Output: 87,241 Btu / Hour.

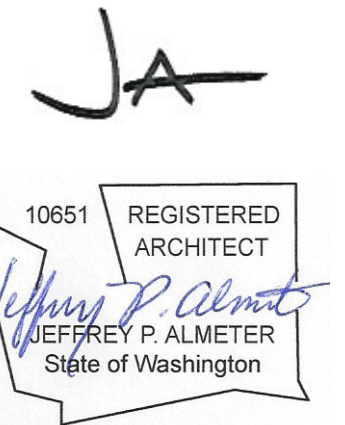

MERCER RESIDENCE 6550 MAKER STREET MERCER ISLAND, WA

ENERGY FORMS

RELEASE 21 MARCH 2022 PERMIT CORRECTIONS 20 FEBRUARY 2023 PERMIT CORRECTIONS 2 JUNE 2023

LEGAL DESCRIPTION

(PER PERSONAL REPRESENTATIVE DEED RECORDING# 20210415002461)
 LOTS 46, 47, 48 AND THE WEST ONE-HALF OF LOT 49 IN BLOCK 3 OF WHITE BROTHERS FIRST ADDITION TO EAST SEATTLE, AS PER PLAT RECORDED IN VOLUME 4 OF PLATS, PAGE 100, RECORDS OF KING COUNTY AUDITOR;
 SITUATE IN THE CITY OF MERCER ISLAND, COUNTY OF KING, STATE OF WASHINGTON.

BASIS OF BEARINGS

HELD N 88°48'41" W BETWEEN MONUMENTS FOUND ON THE CENTERLINE OF SE 32ND ST PER GPS OBSERVATIONS, NAD83/2011 WASHINGTON STATE PLANE, NORTH ZONE.

REFERENCES

R1. RECORD OF SURVEY, VOL. 133, PG. 28.
 R2. RECORD OF SURVEY, VOL. 7, PG. 171.
 R3. PLAT OF WHITE & NOBLES FIRST ADD., REC. NO. 1889050232489, RECORDS OF KING COUNTY, WASHINGTON.

VERTICAL DATUM

NAVD88, PER GPS OBSERVATIONS.

SURVEYOR'S NOTES

1. THE TOPOGRAPHIC SURVEY SHOWN HEREON WAS PERFORMED IN MAY OF 2021. THE FIELD DATA WAS COLLECTED AND RECORDED ON MAGNETIC MEDIA THROUGH AN ELECTRONIC THEODOLITE. THE DATA FILE IS ARCHIVED ON DISC OR CD. WRITTEN FIELD NOTES MAY NOT EXIST. CONTOURS ARE SHOWN FOR CONVENIENCE ONLY. DESIGN SHOULD RELY ON SPOT ELEVATIONS.
2. ALL MONUMENTS SHOWN HEREON WERE LOCATED DURING THE COURSE OF THIS SURVEY UNLESS OTHERWISE NOTED.
3. THE TYPES AND LOCATIONS OF ANY UTILITIES SHOWN ON THIS DRAWING ARE BASED ON INFORMATION PROVIDED TO US, BY OTHERS OR GENERAL INFORMATION READILY AVAILABLE IN THE PUBLIC DOMAIN INCLUDING, AS APPLICABLE, IDENTIFYING MARKINGS PLACED BY UTILITY LOCATE SERVICES AND OBSERVED BY TERRANE IN THE FIELD. AS SUCH, THE UTILITY INFORMATION SHOWN ON THESE DRAWINGS ARE FOR INFORMATIONAL PURPOSES ONLY AND SHOULD NOT BE RELIED ON FOR DESIGN OR CONSTRUCTION PURPOSES; TERRANE IS NOT RESPONSIBLE OR LIABLE FOR THE ACCURACY OR COMPLETENESS OF THIS UTILITY INFORMATION. FOR THE ACCURATE LOCATION AND TYPE OF UTILITIES NECESSARY FOR DESIGN AND CONSTRUCTION, PLEASE CONTACT THE SITE OWNER AND THE LOCAL UTILITY LOCATE SERVICE (800-424-5555).
4. SUBJECT PROPERTY TAX PARCEL NO. 9350900620.
5. SUBJECT PROPERTY AREA PER THIS SURVEY IS 8,750± S.F. (0.20 ACRES)
6. THIS SURVEY WAS PERFORMED WITHOUT THE BENEFIT OF A TITLE REPORT, EASEMENTS AND OTHER ENCUMBRANCES MAY EXIST THAT ARE NOT SHOWN HEREON.
7. FIELD DATA FOR THIS SURVEY WAS OBTAINED BY DIRECT FIELD MEASUREMENTS WITH A CALIBRATED ELECTRONIC 5-SECOND TOTAL STATION AND/OR SURVEY GRADE GPS OBSERVATIONS. ALL ANGULAR AND LINEAR RELATIONSHIPS ARE ACCURATE AND MEET THE STANDARDS SET BY WAC 332-130-090.

LEGEND

	AREA DRAIN		NAIL AS NOTED
	ASPHALT SURFACE		PAVER SURFACE
	BUILDING		POWER METER
	CENTERLINE ROW		POWER (OVERHEAD)
	COLUMN		ROCKERY
	CONCRETE SURFACE		SEWER LINE
	RETAINING WALL		SEWER MANHOLE
	DECK		STORM DRAIN LINE
	FENCE LINE (WOOD)		SEWER CLEANOUT
	GAS METER		TREE (AS NOTED)
	INLET (TYPE 1)		WATER LINE
	MONUMENT IN CASE (FOUND)		WATER METER
	MONUMENT (SURFACE, FOUND)		WATER VALVE

VICINITY MAP
N.T.S.



TOPOGRAPHIC & BOUNDARY SURVEY

STEEP SLOPE/BUFFER DISCLAIMER:

THE LOCATION AND EXTENT OF STEEP SLOPES SHOWN ON THIS DRAWING ARE FOR INFORMATIONAL PURPOSES ONLY AND CANNOT BE RELIED ON FOR DESIGN AND/OR CONSTRUCTION. THE PITCH, LOCATION, AND EXTENT ARE BASED SOLELY ON OUR GENERAL OBSERVATIONS ON SITE AND OUR CURSORY REVIEW OF READILY AVAILABLE PUBLIC DOCUMENTS; AS SUCH, TERRANE CANNOT BE LIABLE OR RESPONSIBLE FOR THE ACCURACY OR COMPLETENESS OF ANY STEEP SLOPE INFORMATION. ULTIMATELY, THE LIMITS AND EXTENT OF ANY STEEP SLOPES ASSOCIATED WITH ANY SETBACKS OR OTHER DESIGN OR CONSTRUCTION PARAMETERS MUST BE DISCUSSED AND APPROVED BY THE REVIEWING AGENCY BEFORE ANY CONSTRUCTION CAN OCCUR.

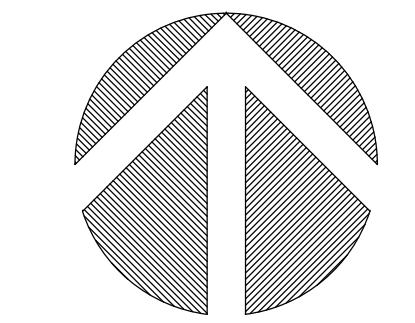

(IN FEET)
1 INCH = 10 FT.

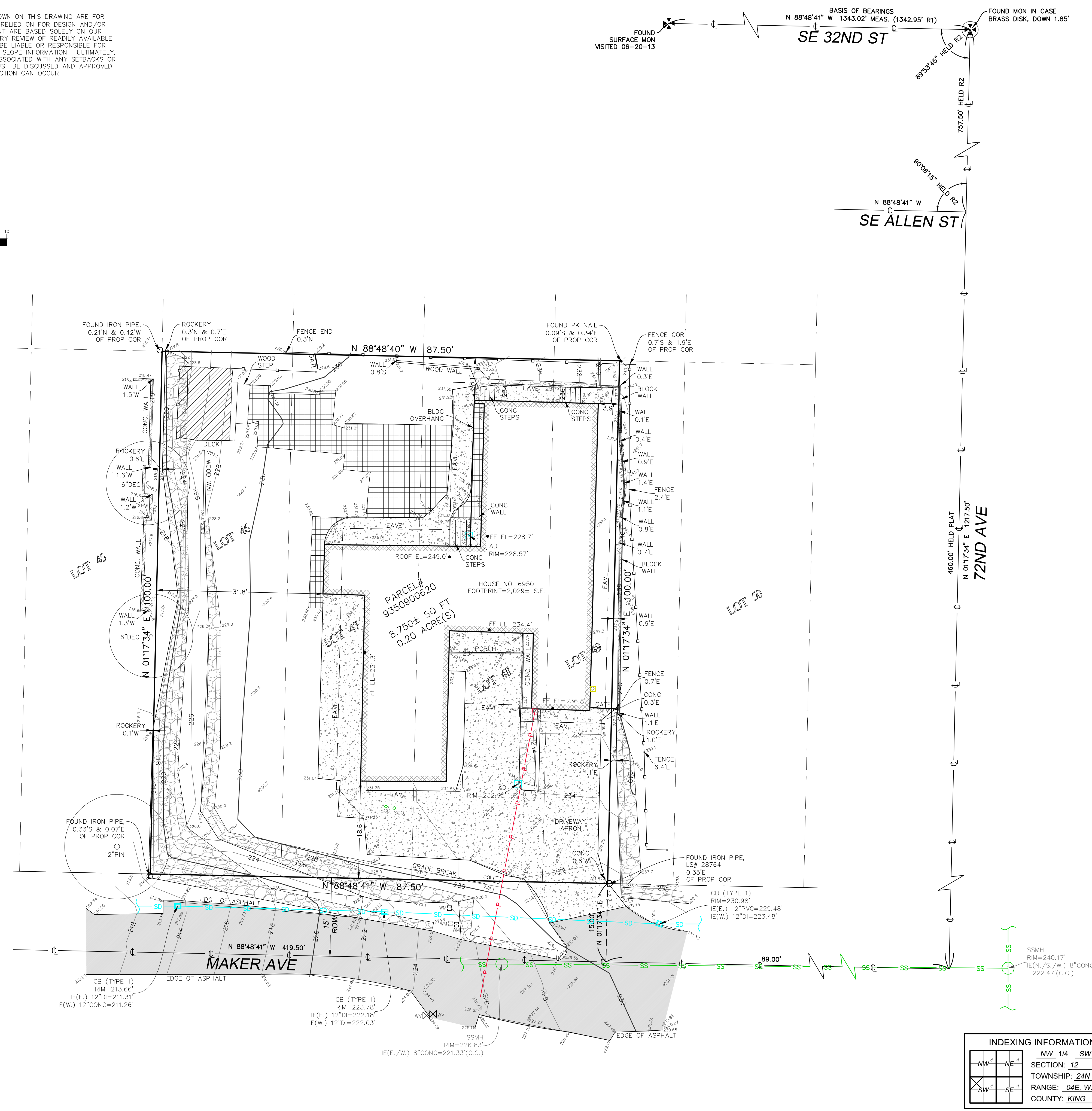

INDEXING INFORMATION

NW	1/4	SW	1/4
NE	1/4	SE	1/4
SECTION:	12		
TOWNSHIP:	24N		
RANGE:	04E, W.M.		
COUNTY:	KING		

measure success

TOPOGRAPHIC & BOUNDARY SURVEY
 PARCEL NO. 9350900620
STRAND RESIDENCE
 6950 SE MAKER STREET
 MERCER ISLAND, WA 98040

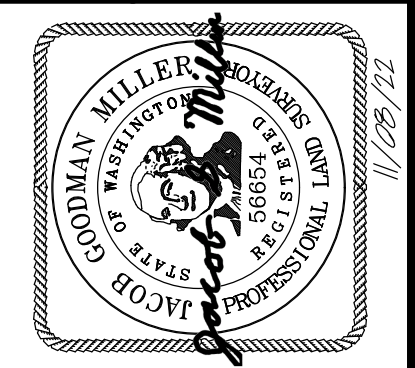

Terrane
 10801 Main Street, Suite 102, Bellevue, WA 98004
 phone 425.458.4488 support@terrane.net
 www.terrane.net

JOB NUMBER: 210007
DATE: 05/27/2021
DRAFTED BY: RSN
CHECKED BY: TBR / JGM
SCALE: 1" = 10'
REVISION HISTORY

DATE	DESCRIPTION
11/8/22	ADD CATCH BASIN

SHEET NUMBER
1 OF 1

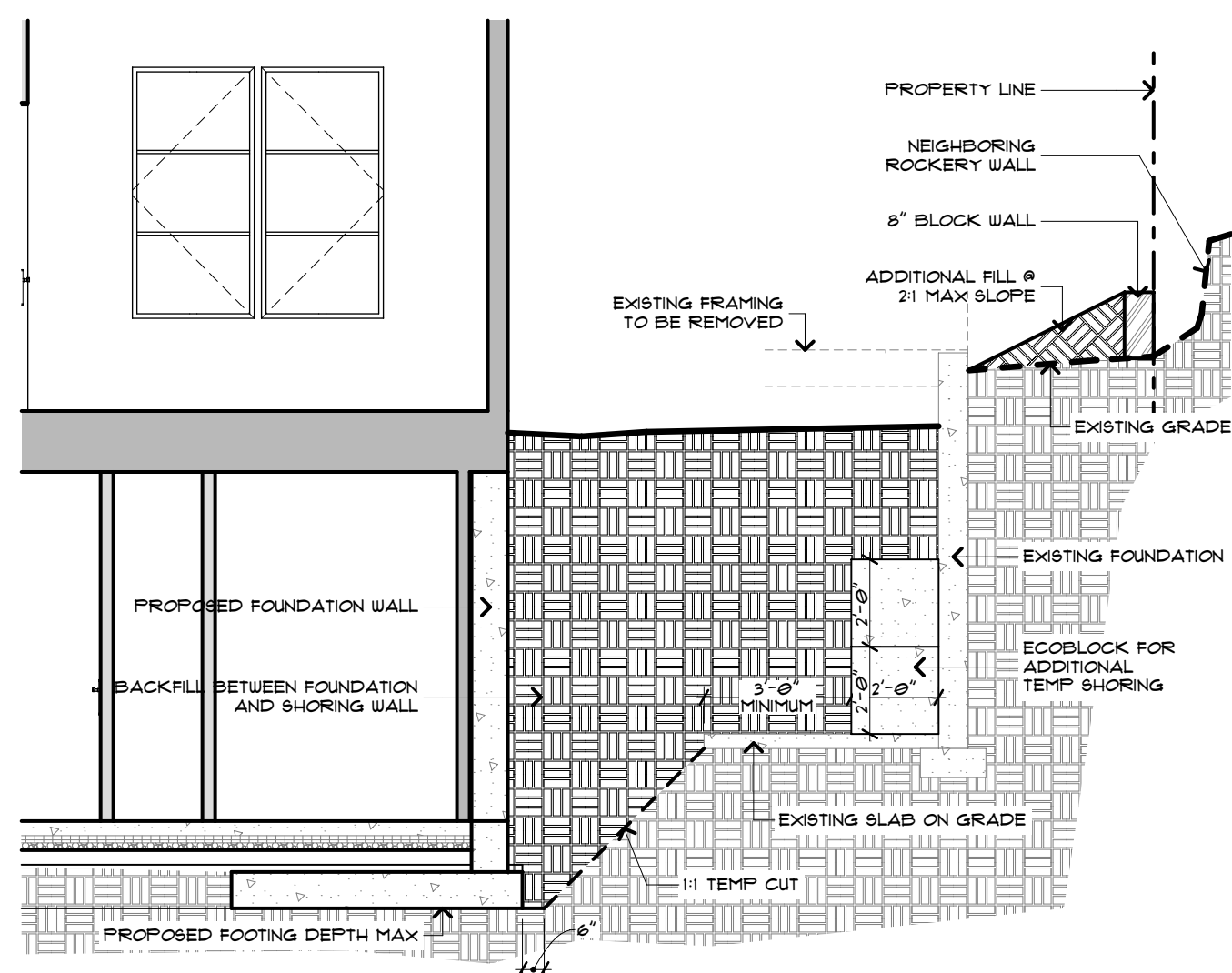

SECTION SH4 4
SCALE: 1/4" = 1'-0"

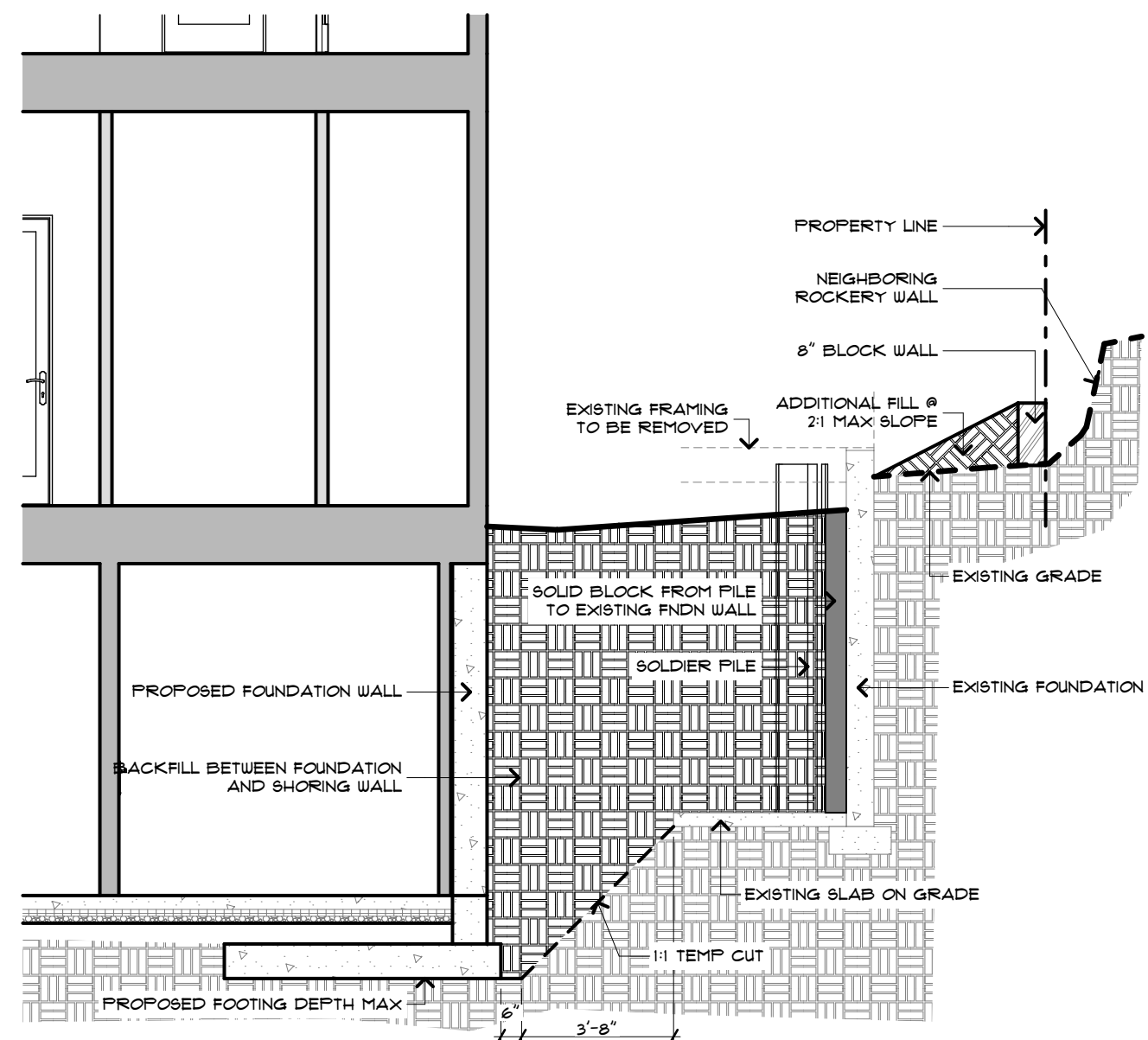

SECTION SH3 3
SCALE: 1/4" = 1'-0"

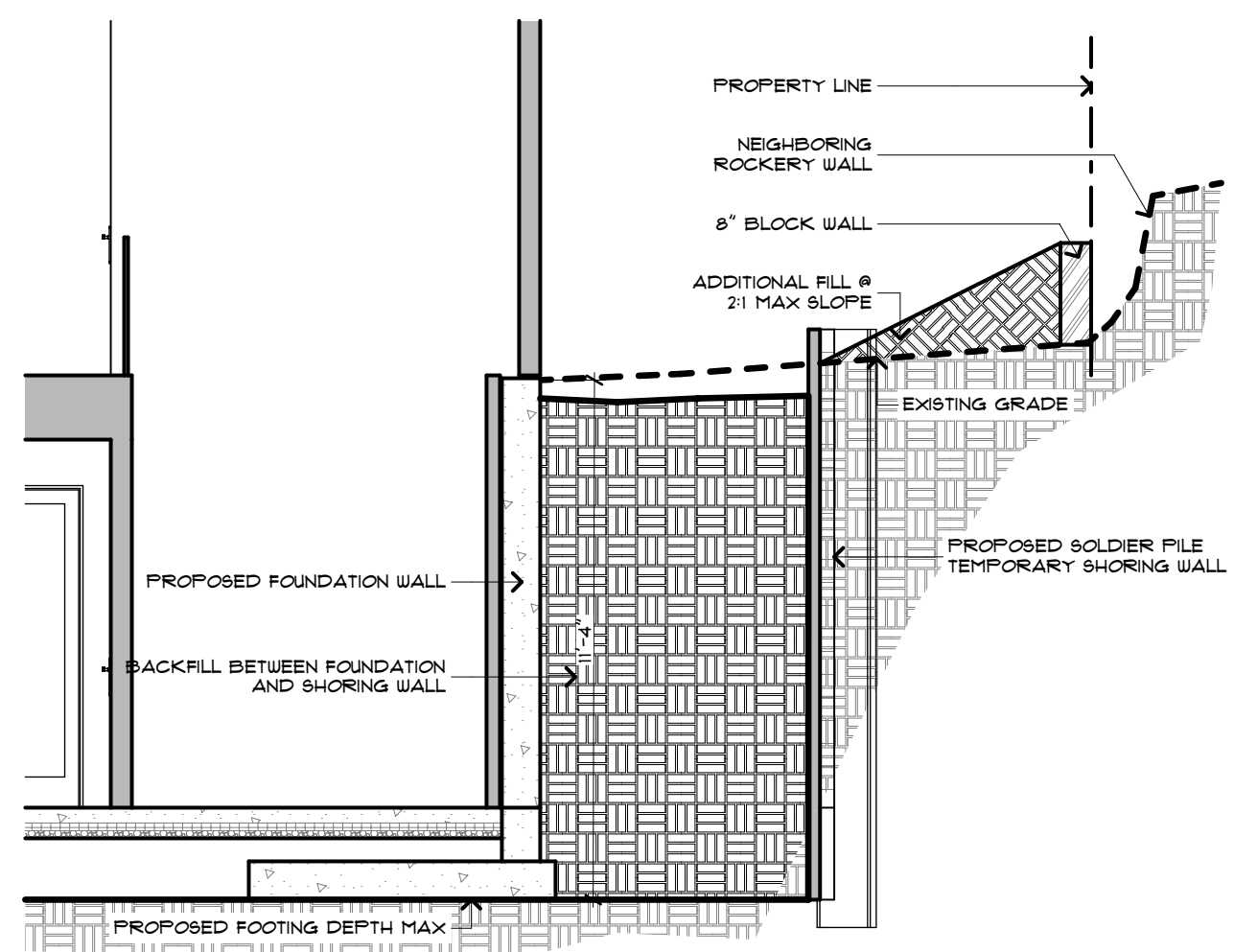

SECTION SH2 2
SCALE: 1/4" = 1'-0"

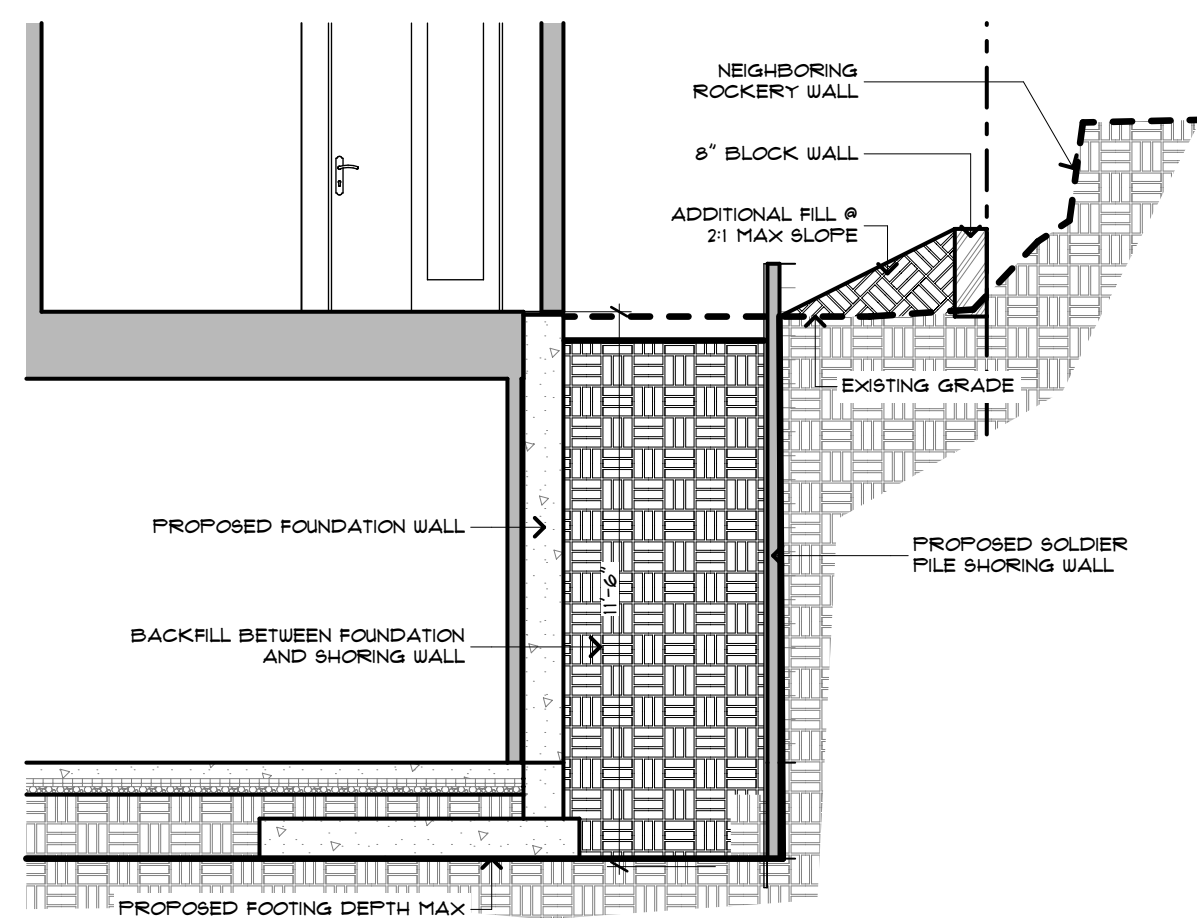

SECTION SH1 1
SCALE: 1/4" = 1'-0"

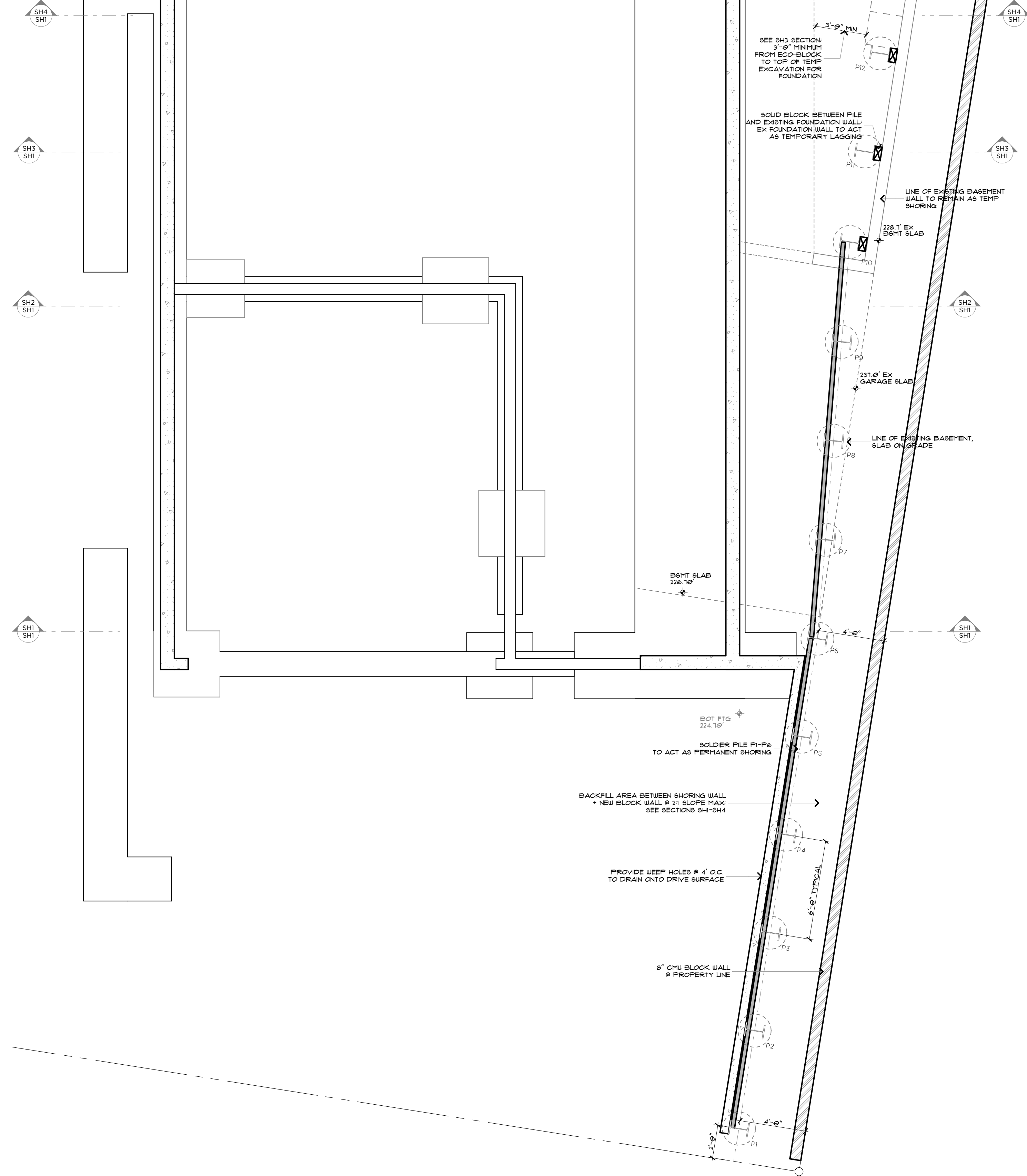

TEMPORARY SHORING PLAN
SCALE: 1/4" = 1'-0"

General Structural Notes

The Following Apply Unless Noted Otherwise on the Drawings

Criteria

- CODE REQUIREMENTS: ALL DESIGN AND CONSTRUCTION SHALL CONFORM TO THE REQUIREMENTS OF THE INTERNATIONAL BUILDING CODE, 2018 EDITION.
- REFERENCE DOCUMENTS:
 - TOPOGRAPHIC AND BOUNDARY SURVEY BY Terrane DATED May 27, 2021
 - REPORT ON GEOTECHNICAL INVESTIGATION BY Geotech Consultants, INC, DATED MARCH 21 2022, (Proj #JN-22007)
- DESIGN LOADS: THE SOIL PRESSURE INDICATED ON THE SOIL PRESSURE DIAGRAMS WHERE USED FOR DESIGN.
- SOILS INSPECTION: INSPECTION BY THE SOILS ENGINEER SHALL BE PERFORMED FOR PILE PLACEMENT. ALL PREPARED SOIL BEARING SURFACES SHALL BE INSPECTED BY THE SOILS ENGINEER PRIOR TO PLACEMENT OF PILE. SOIL COMPACTION SHALL BE SUPERVISED/TESTED BY THE GEOTECHNICAL ENGINEER.
- SPECIAL INSPECTION: SPECIAL INSPECTION OF THE FOLLOWING TYPES OF CONSTRUCTION SHALL BE PROVIDED IN ACCORDANCE WITH SECTIONS 110 AND 1701 OF THE INTERNATIONAL BUILDING CODE AND THE PROJECT SPECIFICATIONS BY A QUALIFIED TESTING AGENCY DESIGNATED BY THE ARCHITECT, AND RETAINED BY THE BUILDING OWNER. THE ARCHITECT, STRUCTURAL ENGINEER, AND BUILDING DEPARTMENT SHALL BE FURNISHED WITH COPIES OF ALL INSPECTION AND TEST RESULTS.

-STRUCTURAL STEEL FABRICATION AND ERECTION (INCLUDING FIELD WELDING AND HIGH-STRENGTH FIELD BOLTING)

- UTILITY LOCATION: THE SHORING CONTRACTOR SHALL DETERMINE THE LOCATION OF ALL ADJACENT UNDERGROUND UTILITIES PRIOR TO DRILLING PILE HOLES OR CUTTING OR DIGGING IN STREETS OR ALLEYS. THE UTILITIES INFORMATION SHOWN ON THE PLANS MAY BE NOT COMPLETE.
- SPECIAL CONDITIONS: CONTRACTOR SHALL VERIFY ALL DIMENSIONS OF EXISTING STRUCTURES IN THE FIELD AND SHALL NOTIFY THE ENGINEER OF ALL FIELD CHANGES PRIOR TO FABRICATION AND INSTALLATION.
- SOILS: SEE REPORT OF GEOTECHNICAL INVESTIGATION FOR MORE COMPLETE INFORMATION, INCLUDING RECOMMENDATIONS FOR SHORING IN GENERAL, SHORING MONITORING, EXCAVATION, LAGGING, AND DRAINAGE.
- SAWN LUMBER: SAWN LUMBER SHALL CONFORM TO "GRADING AND DRESSING RULES," WEST COAST LUMBER INSPECTION BUREAU (WCLIB), LATEST EDITION. LUMBER SHALL BE THE SPECIES AND GRADE NOTED IN THE LAGGING TABLE.

TIMBER LAGGING SHALL BE PRESSURE TREATED WITH WATERBORNE PRESERVATIVES IN ACCORDANCE WITH AWPB STANDARD U1 AND SHALL MEET A USE CATEGORY OF UC4B OR BETTER. LAGGING SHALL BE 4X10 UNLESS OTHERWISE NOTED ON DRAWINGS.

- STEEL SPECIFICATIONS: DESIGN, FABRICATION AND ERECTION SHALL BE IN ACCORDANCE WITH THE LATEST EDITIONS OF THE FOLLOWING SPECIFICATIONS:

- STRUCTURAL STEEL: AISC SPECIFICATION FOR STRUCTURAL STEEL BUILDINGS—ALLOWABLE STRESS DESIGN.
- WELDING: AWS D1.1 (AWS PREQUALIFIED JOINT DETAILS USE 1/4" MINIMUM WELDS UNLESS NOTED OTHERWISE).
- WELDER CERTIFICATION: WASHINGTON ASSOCIATION OF BUILDING OFFICIALS (WABO).vv

- STRUCTURAL STEEL SHALL CONFORM TO THE FOLLOWING REQUIREMENTS:

TYPE OF MEMBER	ASTM SPECIFICATION	F _y
WIDE FLANGE	A992	50 KSI
PIPE	A53	35 KSI
PLATES, SHAPES, ANGLES, AND RODS	A36	36 KSI
STRUCTURAL BOLTS	A325-N	
WOOD CONNECTION BOLTS	A307	
WELDING ELECTRODES	E70XX	

Concrete

- CONCRETE: CONCRETE WORK SHALL CONFORM TO ALL REQUIREMENTS OF CHAPTER 19 OF THE 2018 IBC. CONCRETE STRENGTHS SHALL BE VERIFIED BY STANDARD CYLINDER TESTS, UNLESS APPROVED OTHERWISE. REQUIRED ULTIMATE COMPRESSIVE STRENGTH OF STRUCTURAL GROUT SHALL BE REACHED BY 7 DAYS FOR TIEBACKS AND 28 DAYS FOR PILES.

f _c (psi)	Minimum Cement Per Cubic Yard	Max. Water Per 94 LB Cement	Use
----	1-1/2 Sacks	----	Pile lean concrete
3,000	6 Sacks (PILING)	6 Gallons	Pile struct. grout

CONCRETE WALL SHALL ATTAIN A 28-DAY STRENGTH OF f_c=3,000 PSI

AS AN ALTERNATIVE TO THE ABOVE, THE CONTRACTOR SHALL SUBMIT CONCRETE MIX DESIGNS FOR APPROVAL TWO WEEKS PRIOR TO PLACING ANY CONCRETE. THE ALTERNATE MIX DESIGN WILL BE REVIEWED FOR CONFORMANCE TO ACI 318 Ch. 5 WITH SBC REVISIONS.

- ALL CONCRETE WITH SURFACES EXPOSED TO WEATHER OR STANDING WATER SHALL BE AIR-ENTRAINED WITH AN AIR-ENTRAINING AGENT CONFORMING TO ASTM C260, C494, AND C618. TOTAL AIR CONTENT FOR FROST-RESISTANT CONCRETE SHALL BE IN ACCORDANCE WITH TABLE ACI 318 TABLE 4.2.1 MODERATE EXPOSURE.
- REINFORCING STEEL SHALL CONFORM TO ASTM A615 (INCLUDING SUPPLEMENT S1), GRADE 60, f_y=60,000 PSI. EXCEPTIONS: ANY BARS SPECIFICALLY SO NOTED ON THE DRAWINGS SHALL BE GRADE 40, f_y=40,000 PSI. WELDED WIRE FABRIC SHALL CONFORM TO ASTM A-185. SPIRAL REINFORCEMENT SHALL BE PLAIN WIRE CONFORMING TO ASTM A615, GRADE 60, f_y=60,000 PSI.

Pipe and Lagging Construction

- DEMOLITION: SHORING AND SOIL EXCAVATION SHALL BE DONE SIMULTANEOUSLY.
- VERIFICATION: DIMENSIONS AND LOCATION OF EXISTING STRUCTURES SHALL BE VERIFIED PRIOR TO FABRICATION AND INSTALLATION OF ANY STRUCTURAL MEMBER. NOTIFY ENGINEER ABOUT ANY DISCREPANCIES PRIOR TO FABRICATION.
- STEEL PILE PLACEMENT TOLERANCES:
 - 1" INSIDE PERPENDICULAR TO SHORING WALL.
 - 1" OUTSIDE PERPENDICULAR TO SHORING WALL.
 - 3" LATERALLY.
- LAGGING: TIMBER LAGGING SHALL BE INSTALLED IN ALL AREAS. VOIDS BETWEEN LAGGING AND SOIL SHALL BE BACKFILLED PER THE GEOTECHNICAL ENGINEERS RECOMMENDATIONS. DRAINAGE BEHIND THE WALL MUST BE MAINTAINED. IT IS CONTRACTOR'S RESPONSIBILITY TO LIMIT THE AMOUNT OF EXPOSED SOIL WITHOUT LAGGING TO AVOID LOSS OF SOIL. MAXIMUM HEIGHT OF 4 FEET IS RECOMMENDED. SPECIAL CARE SHOULD BE TAKEN TO AVOID GROUND LOSS DURING EXCAVATION.
- SHORING MONITORING: A SYSTEMATIC PROGRAM OF OBSERVATION SHALL BE CONDUCTED DURING THE PROJECT EXECUTION TO DETERMINE THE EFFECT OF CONSTRUCTION ON ADJACENT FACILITIES AND STRUCTURES IN ORDER TO PROTECT THEM FROM DAMAGE. REFER TO REPORT OF GEOTECHNICAL INVESTIGATION FOR RECOMMENDATIONS. FIELD DATA AND MEASUREMENTS ARE TO BE SUBMITTED TO STRUCTURAL AND GEOTECHNICAL ENGINEER FOR REVIEW.

MONITORING PLAN SHALL INCLUDE THE FOLLOWING:

- THE TOP OF EVERY OTHER PILE SHALL BE MONITORED.
- MULTIPLE REFERENCE POINTS SHOULD BE ESTABLISHED SUFFICIENTLY FAR AWAY FROM THE SHORING TO ACT AS CONTROL POINTS FOR THE MONITORING PLAN.
- ESTABLISH A BASELINE READING OF MONITORING POINTS ON THE GROUND SURFACE AND SETTLEMENT-SENSITIVE STRUCTURES BEHIND THE SHORING WALL ALIGNMENT PRIOR TO EXCAVATION AND INSTALLATION OF THE SHORING SYSTEMS.
- A LICENSED SURVEYOR MUST DO THE SURVEYING AT LEAST ONCE A WEEK.
- SURVEY FREQUENCY CAN BE DECREASED AFTER THE SHORING SYSTEM HAS BEEN INSTALLED AND EXCAVATION IS COMPLETE IF THE DATA INDICATES LITTLE OR NO ADDITIONAL MOVEMENT. SURVEYING MUST CONTINUE UNTIL THE PERMANENT STRUCTURE IS COMPLETE UP TO THE TOP OF THE SHORING WALL. THE SURVEY FREQUENCY WILL BE DETERMINED BY THE GEOTECHNICAL ENGINEER AFTER REVIEW AND APPROVAL BY THE CITY OF MERCER ISLAND BUILDING OFFICIAL (COMBO).
- THE GEOTECHNICAL ENGINEER SHALL REVIEW SURVEY DATA AND PROVIDE AN EVALUATION OF WALL PERFORMANCE ALONG WITH SURVEY DATA TO COMBO ON AT LEAST A WEEKLY BASIS. IMMEDIATELY AND DIRECTLY, NOTIFY COMBO IF ANY UNUSUAL OR SIGNIFICANTLY INCREASED MOVEMENT OCCURS.
- IMMEDIATELY AND DIRECTLY NOTIFY THE GEOTECHNICAL AND STRUCTURAL ENGINEERS, IF 0.5 INCHES OF MOVEMENT OCCURS BETWEEN TWO CONSECUTIVE READINGS AND WHEN TOTAL MOVEMENTS REACH 0.5 INCH. AT THAT AMOUNT OF MOVEMENT, THE ENGINEERS AND DESIGNERS SHALL DETERMINE THE CAUSE OF DISPLACEMENT AND DEVELOP REMEDIAL MEASURES SUFFICIENT TO LIMIT TOTAL WALL MOVEMENTS TO WHAT HAS BEEN DEFINED AS ACCEPTABLE BY THE DESIGN TEAM.

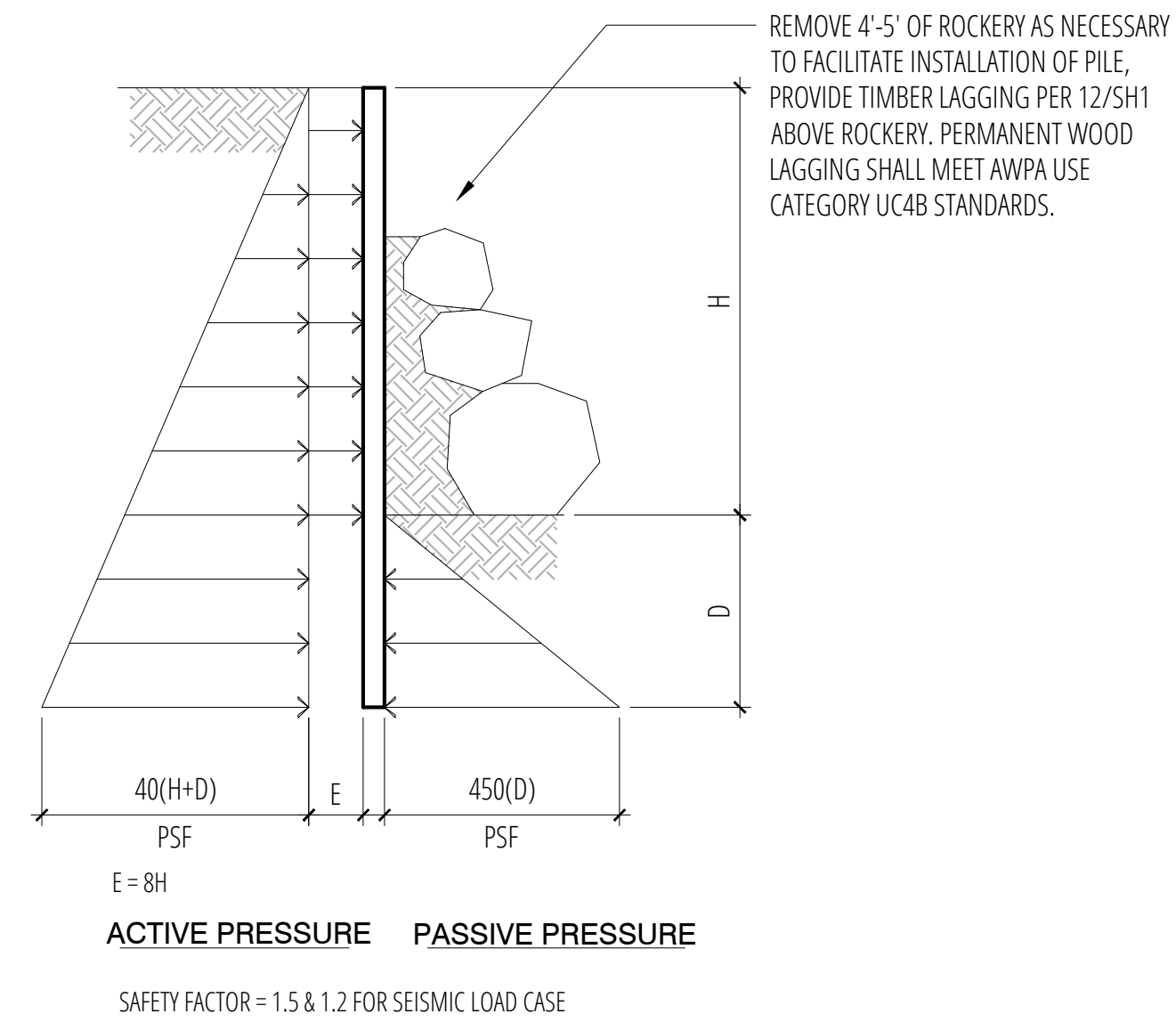

3 West Stabilization Wall Loading Diagram
SCALE: 3/4"=1'-0"

Pile Mark	Auger Dia.	Wide Flange	Max. Height H (ft.)	Min Embed D (ft.)	Min. X (ft.) Above Top of Excavation	Type
P1	24"	W16x100	11'-6"	20'-0"	1'-0"	Cantilever
P2	24"	W16x100	11'-6"	20'-0"	1'-0"	Cantilever
P3	24"	W16x100	11'-6"	20'-0"	1'-0"	Cantilever
P4	24"	W16x100	11'-6"	20'-0"	1'-0"	Cantilever
P5	24"	W16x100	11'-6"	20'-0"	1'-0"	Cantilever
P6	24"	W14x68	11'-6"	15'-0"	1'-0"	Cantilever
P7	24"	W14x68	11'-6"	15'-0"	1'-0"	Cantilever
P8	24"	W14x68	11'-6"	15'-0"	1'-0"	Cantilever
P9	24"	W14x68	11'-6"	15'-0"	1'-0"	Cantilever
P10	24"	W14x68	11'-6"	15'-0"	1'-0"	Cantilever
P11	24"	W14x68	11'-6"	15'-0"	1'-0"	Cantilever
P12	24"	W14x68	11'-6"	15'-0"	1'-0"	Cantilever
P13-P37	24"	W12x40	10'-0"	12'-0"	0'-0"	Cantilever

7 Pile Schedule
SCALE:

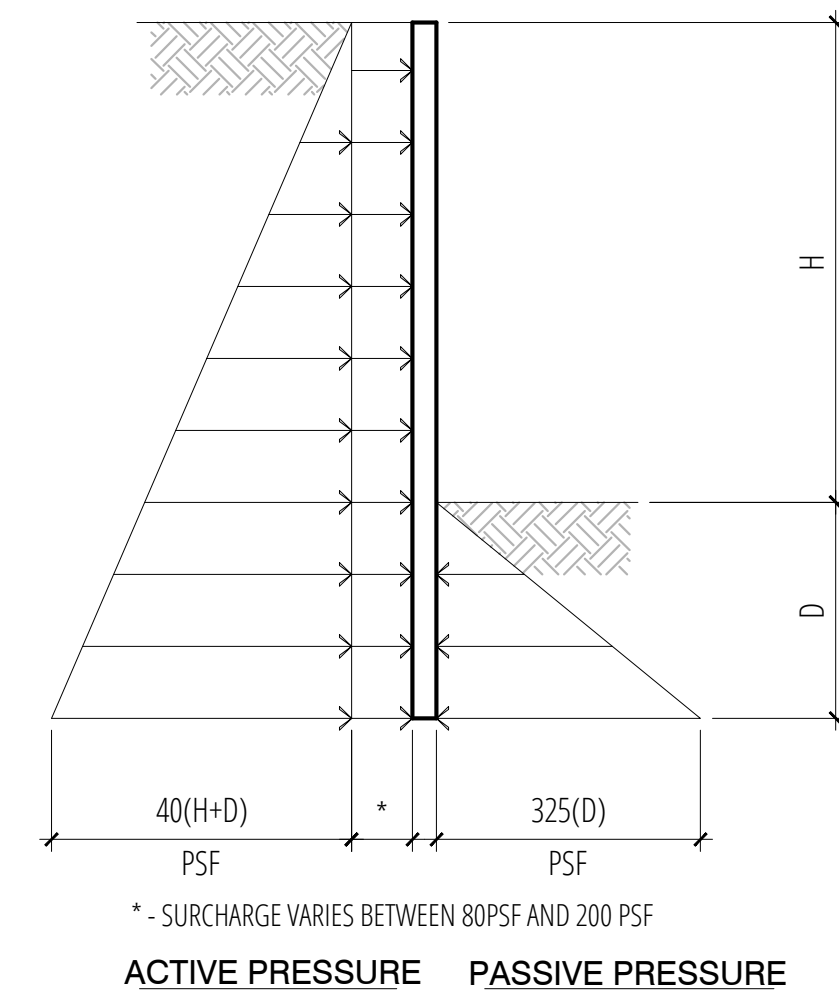

11 Pile Loading Diagram
SCALE: 3/4"=1'-0"

4 SCALE: 3/4"=1'-0"

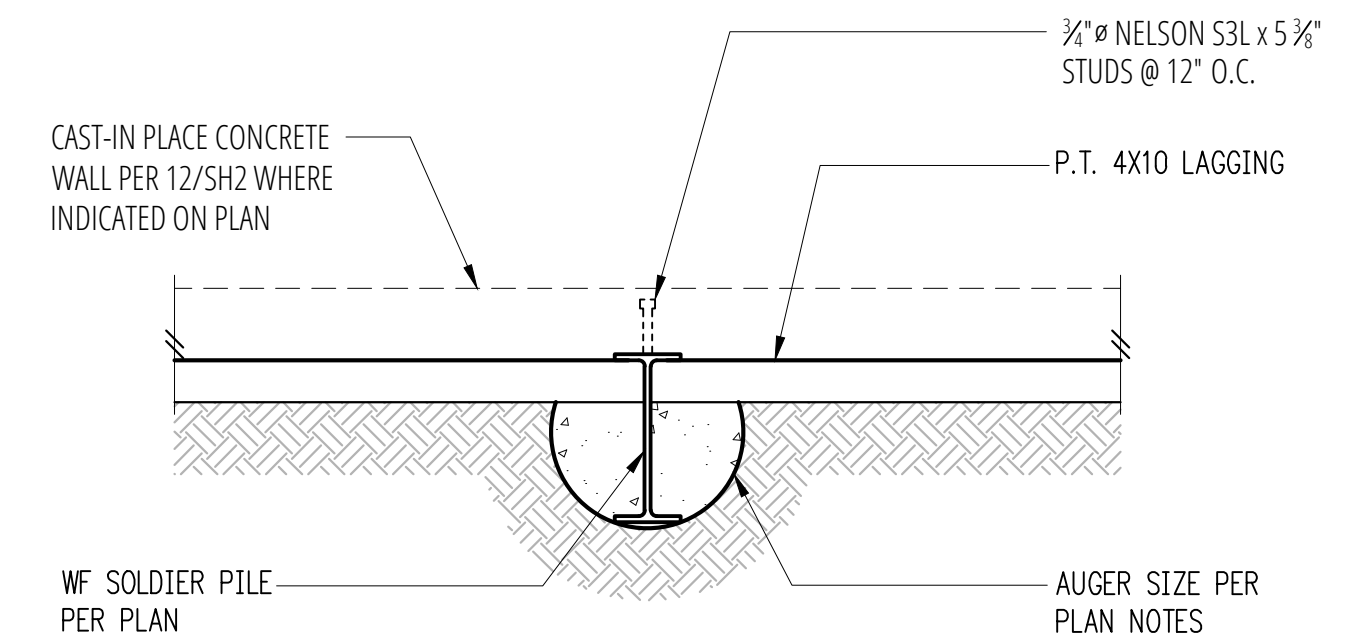

8 Typical Pile Plan
SCALE: 3/4"=1'-0"

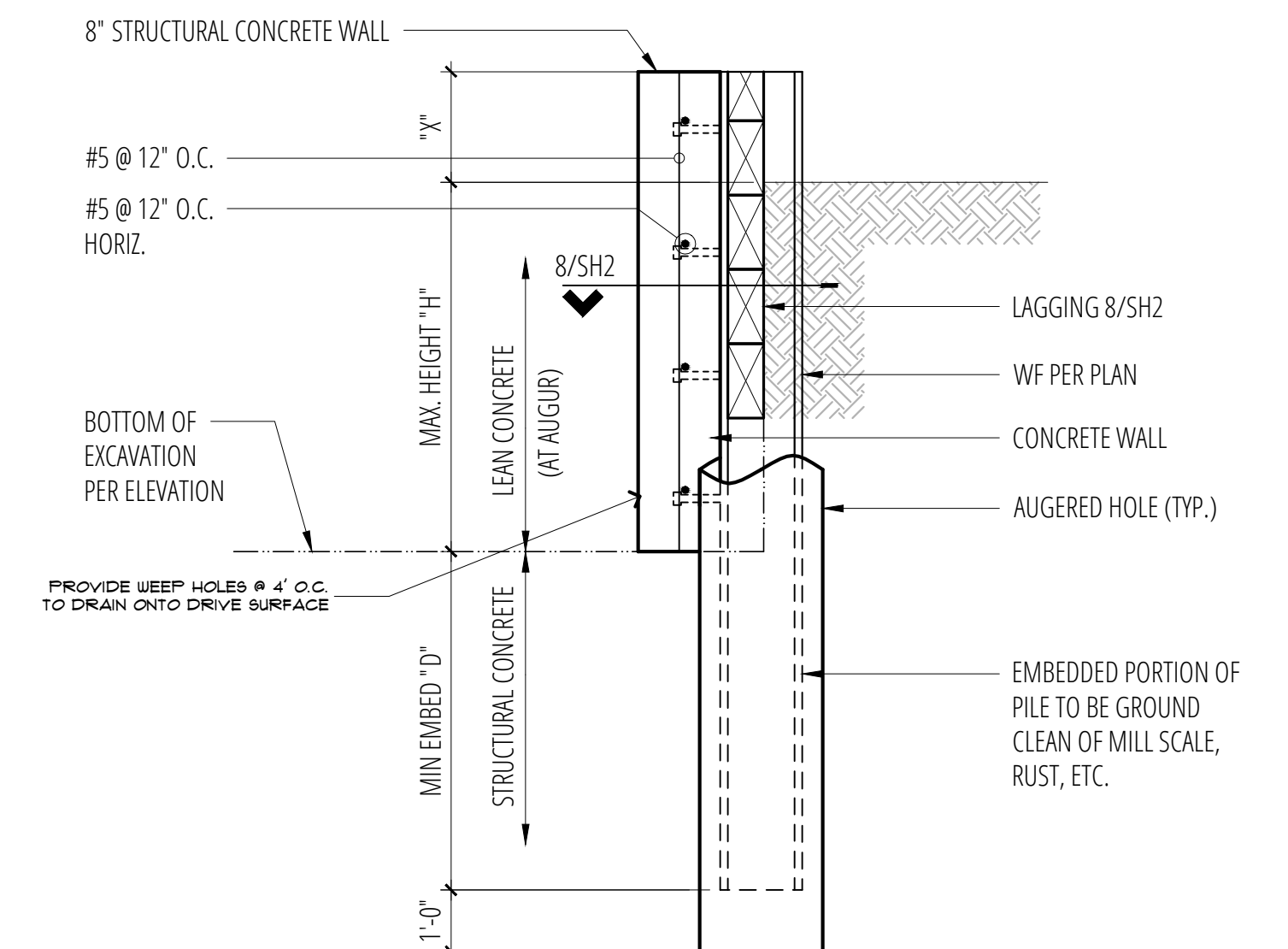

12 Cantilever Pile
SCALE: 3/4"=1'-0"

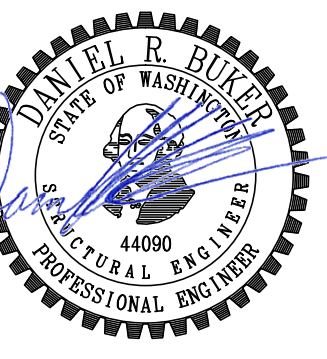

No.	Date	Issue
	1/30/23	Permit
1	4/21/23	Corrections
2	5/17/23	Corrections

Sheet Contents
SHORING NOTES & DETAILS

Sheet No.

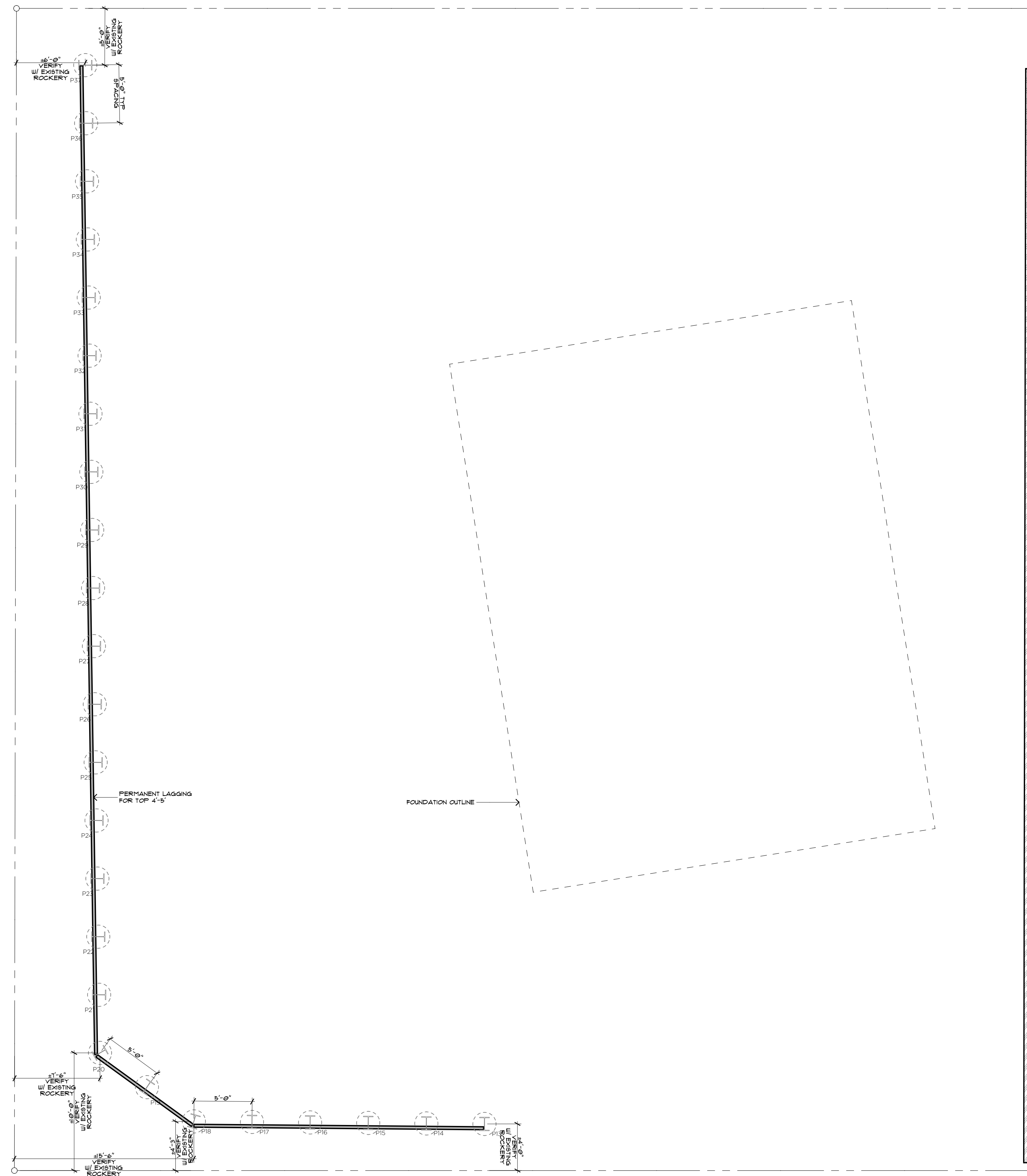

PERMANENT SHORING PLAN

SCALE: 3/16" = 1'-0"

1

MERCER RESIDENCE
6950 SE MAKER ST MERCER ISLAND, WA

PERMANENT SHORING PLAN

RELEASE
PERMIT CORRECTIONS
2 JUNE 2023

SH 3

MAKER AVE
APPROVED 8/20/23

NW 1/4, SW 1/4 SECTION 12, TOWNSHIP 24 N, RANGE 4 E, W.M.
CITY OF MERCER ISLAND, KING COUNTY, WASHINGTON

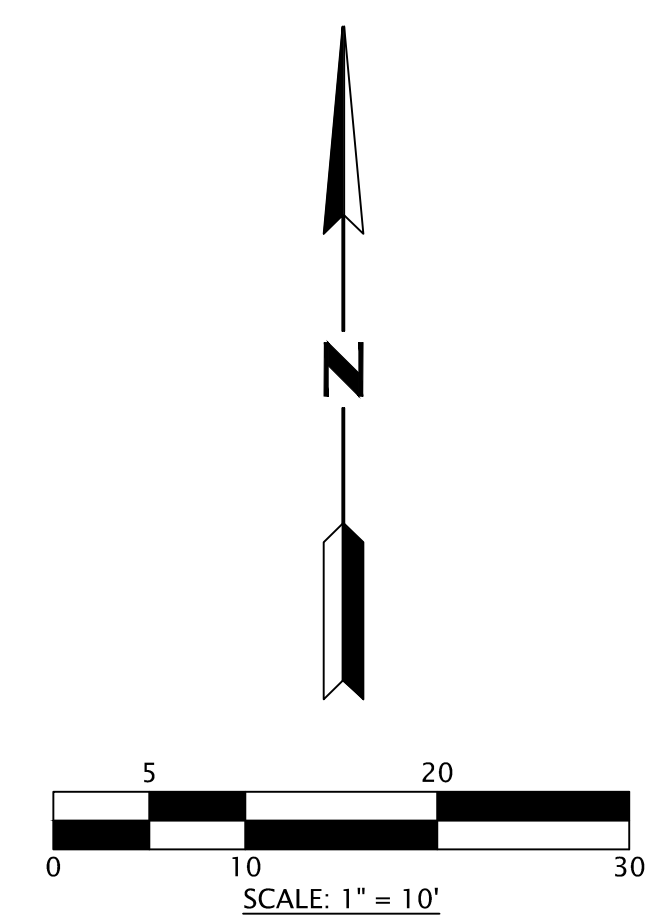
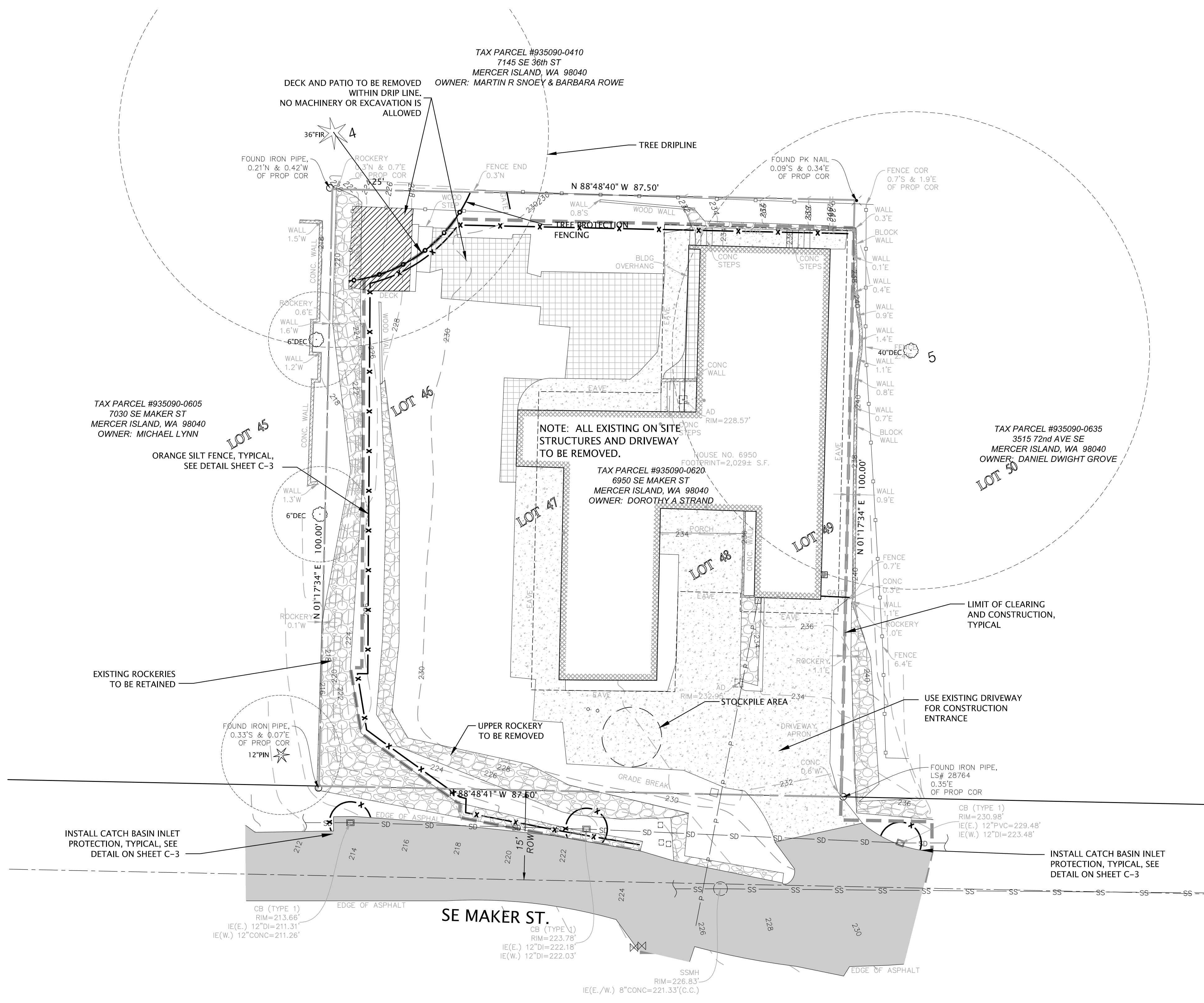

- LEGEND**
- AREA DRAIN
 - ASPHALT SURFACE
 - BUILDING
 - CENTERLINE ROW
 - COLUMN
 - CONCRETE SURFACE
 - RETAINING WALL
 - DECK
 - FENCE LINE (WOOD)
 - GAS METER
 - INLET (TYPE 1)
 - MONUMENT IN CASE (FOUND)
 - MONUMENT (SURFACE, FOUND)
 - NAIL AS NOTED
 - PAVER SURFACE
 - POWER METER
 - POWER (OVERHEAD)
 - ROCKERY
 - SEWER LINE
 - SEWER MANHOLE
 - SEWER CLEANOUT
 - SEWER (AS NOTED)
 - WATER LINE
 - WATER METER
 - WATER VALVE

- LEGEND (EROSION)**
- EXISTING CONTOUR LINE
 - PROPOSED CONTOUR LINE
 - PROPOSED SILT FENCE
 - PROPOSED LIMIT OF CONSTRUCTION
 - PROPOSED CATCH BASIN INSERT
 - EXISTING TREE TO BE RETAINED
 - EXISTING TREE TO BE REMOVED
 - TREE PROTECTION

SURVEY NOTE
EXISTING SURVEY INFORMATION SHOWN HEREON IS BASED ON SURVEY BY TERRANE SURVEYING & MAPPING, AND ELECTRONIC DRAWING FILES AS PROVIDED ON 03/25/2022. SURVEY INFORMATION HAS NOT BEEN FIELD VERIFIED BY GOLDSMITH.

Digitally signed by Mark Barber
Date: 2023.08.25
14:01:35-07'00"



GOLDSMITH
LAND DEVELOPMENT SERVICES
11400 SE 8th St, Suite 450, Bellevue, WA 98004 | PO Box 3565, Bellevue, WA 98009
T 425-462-1080 www.goldsmithengineering.com

PLOTTED:	2023/08/25 13:20	Eoregon
DRAWN:		
DESIGNED:		
APPROVED:		
FIELD BOOK:		
PAGE #:		

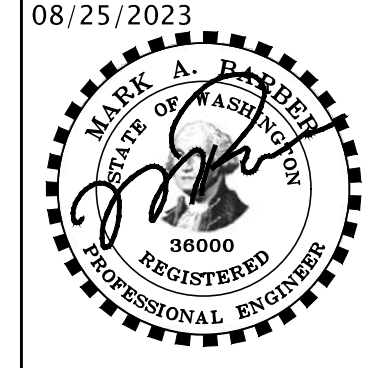

DOROTHY STRAND
TESC PLAN FOR STRAND PROPERTY
6950 SE MAKER ST., CITY OF MERCER ISLAND KING COUNTY, WASHINGTON

JOB NO. 22038
SHEET
C-1

L:\2023\2023-08-25 DEVELOPMENT\CAD\HOST DRAWINGS\BUILDING PERMIT\22038R01.DWG 230825 14:01:35 2023

L:\2023\22038\3 DEVELOPMENT\CAD\HOST DRAWINGS\BUILDING PERMIT\22038R01.DWG

NW ¼, SW ¼ SECTION 12, TOWNSHIP 24 N, RANGE 4 E, W.M.
CITY OF MERCER ISLAND, KING COUNTY, WASHINGTON

**STORM & ROOF DRAINAGE SYSTEM
STRUCTURE TABLE**

NAME	TYPE	VERTICAL	I.E. IN / OUT
CB # 1	TYPE 1, EXISTING	RIM = 213.66	12" SD D.I. IN (E) = 211.31 12" CONC. D.I. OUT (W) = 211.26
CB # 2	TYPE 1, EXISTING TIE INTO	RIM = 223.78	12" EX. SD D.I. IN (E) = 222.18 6" SD PVC IN (N) = 222.03 12" SD D.I. OUT (W) = 222.03
CB # 3	TYPE 1, W/ OIL & WATER SEPARATOR	RIM = 230.77	4" RD PVC IN (N) = 224.90 4" TRENCH RD PCV IN (E) = 224.90 6" SD PVC OUT (S) = 224.90
TRENCH DRAIN	TRENCH DRAIN	RIM = 226.44	4" TRENCH RD PCV OUT (W) = 225.60
X-CB	TYPE I CB	RIM = 230.98	12" PVC IN (E) = 229.48 12" EX. SD D.I. OUT (W) = 229.48
YD # 1	YARD DRAIN	RIM = 230.68	4" RD PVC IN (E) = 227.25 4" RD PVC OUT (S) = 227.25
YD # 2	YARD DRAIN	RIM = 233.08	4" RD PVC IN (S) = 230.57 4" RD PVC OUT (W) = 230.57

**STORM & ROOF DRAINAGE SYSTEM
PIPE TABLE**

PIPE	SIZE	LENGTH	PIPE INFORMATION
1	12"	40 LF	SD D.I. @ 27.09%
2	6"	29 LF	SD PVC @ 9.97%
3	4"	50 LF	RD PVC @ 4.68%
4	4"	44 LF	RD PVC @ 7.46%
5	4"	8 LF	TRENCH RD PCV @ 8.91%
6	12"	53 LF	EX. SD D.I. @ 13.87%
7	4"	47 LF	RD PVC @ 5.75%

**SANITARY SEWER SYSTEM
STRUCTURE TABLE**

NAME	TYPE	VERTICAL	I.E. IN / OUT
EX-SSMH # 1	SSMH, EXISTING	RIM = 226.83	6" PVC IN (N) = 221.91 8" D.I. IN (E) = 221.33 8" D.I. OUT (W) = 221.33
HOUSE	LOWER LEVEL FF	RIM = 226.47	6" PVC OUT (S) = 222.86
SSCO # 1	CLEAN OUT W/ TRAFFIC RATED LID	RIM = 227.93	6" PVC IN (N) = 222.63 6" PVC OUT (SW) = 222.63
SSCO # 2	CLEAN OUT W/ TRAFFIC RATED LID	RIM = 228.70	6" PVC IN (NE) = 222.31 6" PVC OUT (S) = 222.31

**SANITARY SEWER SYSTEM
PIPE TABLE**

PIPE	SIZE	LENGTH	PIPE INFORMATION
1	6"	12 LF	PVC @ 2.00%
2	6"	16 LF	PVC @ 2.00%
3	6"	20 LF	PVC @ 2.00%

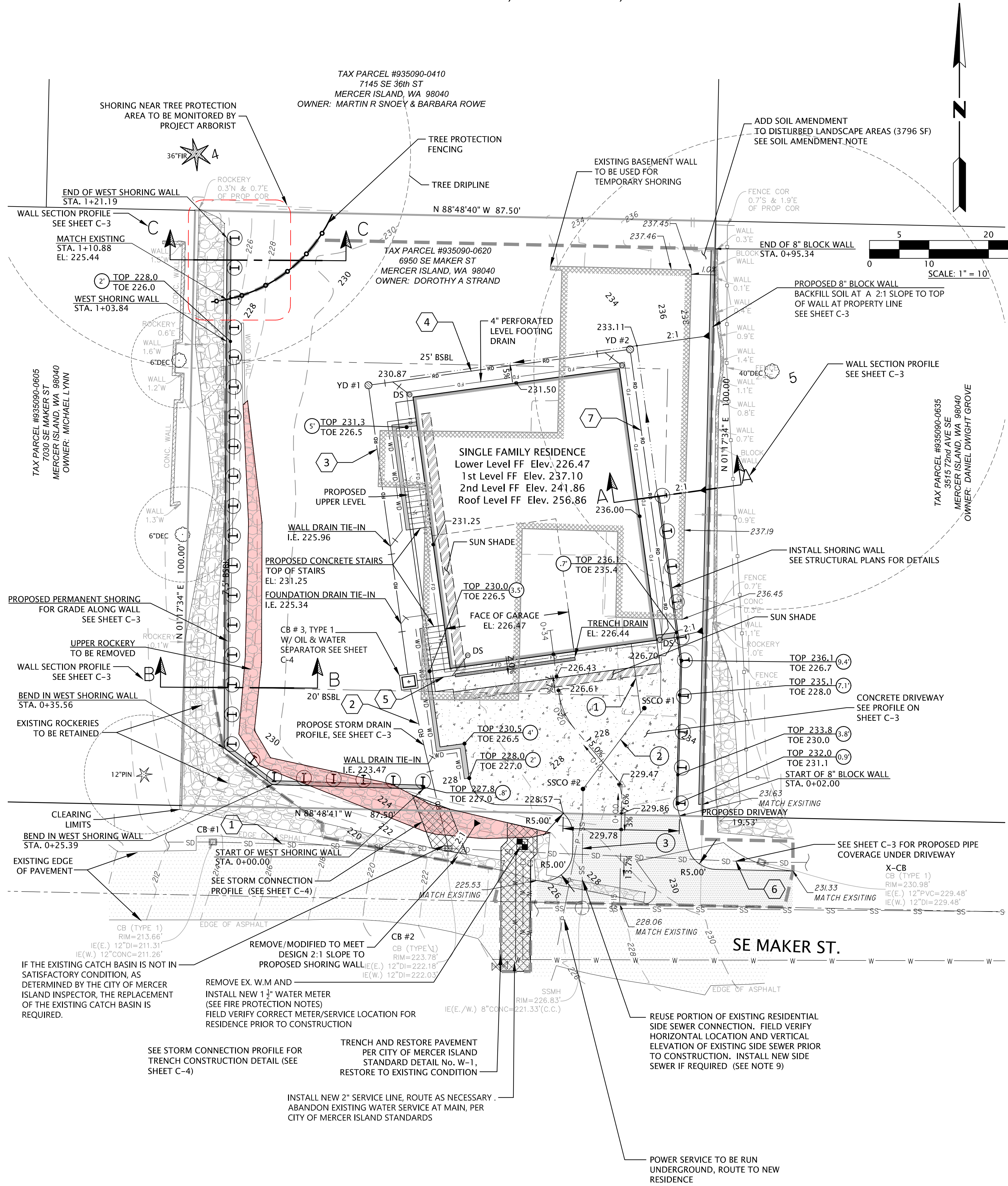

NOTES

- DEMOLISH EXISTING HOUSE, PATIO, DECK, WALKWAY, WALL AND DRIVEWAY PRIOR TO PROPOSED CONSTRUCTION.
- SITE AREA: 8,750 SF (0.20 AC)
- IMPERVIOUS CALCULATIONS:
ON-SITE
HOUSE = 1,888 SF
CONCRETE DRIVEWAY = 804 SF
DECK = 61 SF
STAIRS = 13 SF
RETAINING WALLS = 49 SF
NEW AND REPLACED SUBTOTAL = 2,815 SF
EX. ROCKERY / WALL = 736 SF
TOTAL IMPERVIOUS = 3,537 SF (40% OF LOT AREA)
OFF-SITE
ASPHALT DRIVEWAY = 485 SF
TOTAL PROJECT IMPERVIOUS = 4,022 SF
- EARTHWORK QUANTITY:
CUT = 662.75 CY
FILL = 19.92 CY
- ROOF DRAIN PIPES SHALL MEET MATERIAL STANDARDS FOR SDR35 FOR PVC PIPE AND N-12 FOR SMOOTH-BORE HDPE PIPE.
- FOOTING DRAIN PIPES SHALL MEET MATERIAL STANDARDS FOR D2729 FOR PVC, WITH THE PERFORATIONS DIRECTED DOWNWARD.
- CONTRACTOR SHALL COMPLY WITH THE CITY OF MERCER ISLAND "STORM DRAINAGE REQUIREMENTS" FOR ALL NEW CONSTRUCTION OF DRAINAGE SYSTEM IMPROVEMENTS, INCLUDING ROOF DRAINS, FOOTING DRAINS, AND DRIVEWAY/PARKING AREA DRAINS.
- CONTRACTOR TO COORDINATE EXACT LOCATION OF THE NEW METER WITH THE CITY'S WATER DEPARTMENT DURING CONSTRUCTION.
- THE TV INSPECTION OF THE EXISTING SIDE SEWER TO THE CITY SEWER MAIN ON SE MAKER ST IS REQUIRED PRIOR TO ANY WORK RELATED TO THE SIDE SEWER. IF THE RESULT OF THE TV INSPECTION IS NOT IN SATISFACTORY CONDITION, AS DETERMINED BY THE CITY OF MERCER ISLAND INSPECTOR, THE REPLACEMENT OF THE EXISTING SIDE SEWER IS REQUIRED.

LEGEND (DEVELOPED)

- PROPOSED CONCRETE
- PROPOSED ASPHALT PAVEMENT
- TRENCH RESTORATION
- PROPOSED WALL TO BE REMOVED
- PROPOSED SANITARY SIDE SEWER
- PROPOSED SANITARY SIDE SEWER CLEANOUT
- PROPOSED WATER SERVICE LINE
- PROPOSED WATER METER
- PROPOSED YARD DRAIN
- PROPOSED ROOF DRAIN PIPE
- PROPOSED ROOF DRAIN CLEANOUT
- PROPOSED FOOTING DRAIN PIPE
- PROPOSED FOOTING DRAIN PIPE
- PROPOSED DOWNSPOUT
- PROPOSED CONTOUR LINE
- PROPOSED CATCH BASIN, TYPE I

FIRE PROTECTION NOTES:

- FIRE SPRINKLER REQUIRED
- BUILDER AND FIRE PROTECTION DESIGNER TO CONFIRM METER AND WATER SERVICE SIZE PRIOR TO CONSTRUCTION OF WATER SERVICE

SURVEY NOTE

EXISTING SURVEY INFORMATION SHOWN HEREON IS BASED ON SURVEY BY TERRANE SURVEYING & MAPPING, AND ELECTRONIC DRAWING FILES AS PROVIDED ON 03/25/2022. SURVEY INFORMATION HAS NOT BEEN FIELD VERIFIED BY GOLDSMITH.

TEMPORARY SHORING

TEMPORARY SHORING SHALL BE INSTALLED AT THE DIRECTION OF THE PROJECT GEOTECHNICAL ENGINEER.

SOIL AMENDMENT NOTE

STOCKPILE AND COMPOST AMENDED DISTURBED LANDSCAPED AREAS PER CITY OF MERCER ISLAND POST-CONSTRUCTION SOIL MANAGEMENT
TOP SOIL LAYER SHALL HAVE A MINIMUM DEPTH OF 8" AND A ORGANIC CONTENT OF 5% IN TURF AREAS AND 10% IN PLANTER BEDS. SUBSOIL BELOW TOP SOIL LAYER SHALL BE SCARIFIED TO A DEPTH OF 4" BELOW TOPSOIL LAYER. PLANTER BEDS SHALL BE MULCH WITH 2" OF ORGANIC MATERIAL.
THE LAWN AND LANDSCAPE AREAS ARE REQUIRED TO PROVIDE POST-CONSTRUCTION SOIL QUALITY AND DEPTH IN ACCORDANCE WITH BMP T5.13. THE PROJECT CIVIL ENGINEER MUST PROVIDE A LETTER OF CERTIFICATION TO ENSURE THAT THE LAWN AND LANDSCAPE AREAS ARE MEETING THE POST-CONSTRUCTION SOIL QUALITY AND DEPTH REQUIREMENTS SPECIFIED ON THE APPROVED PLAN SET PRIOR TO FINAL INSPECTION OF THE PROJECT.



GOLDSMITH
LAND DEVELOPMENT SERVICES
11400 SE 8th St, Suite 450, Bellevue, WA 98004 | PO Box 3565, Bellevue, WA 98009
T 425-462-1080 www.goldsmithengineering.com

PLOTTED: 2023/08/25 13:52 Eoregon
DRAWN:
DESIGNED:
APPROVED:
FIELD BOOK:
PAGE #:

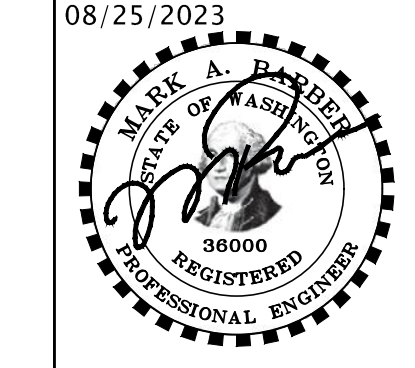

08/25/2023
DOROTHY STRAND
GRADING, DRAINAGE AND UTILITY PLAN
FOR
STRAND PROPERTY
6950 SE MAKER ST., CITY OF MERCER ISLAND KING COUNTY, WASHINGTON

JOB NO. 22038
SHEET
C-2

L:\2023\2023-3 DEVELOPMENT\CAD\HOST DRAWINGS\BUILDING PERMIT\22038P01.dwg 23/08/25 13:52

L:\2023\22038\3 DEVELOPMENT\CAD\HOST DRAWINGS\BUILDING PERMIT\22038P01.dwg

NW ¼, SW ¼ SECTION 12, TOWNSHIP 24 N, RANGE 4 E, W.M.
CITY OF MERCER ISLAND, KING COUNTY, WASHINGTON

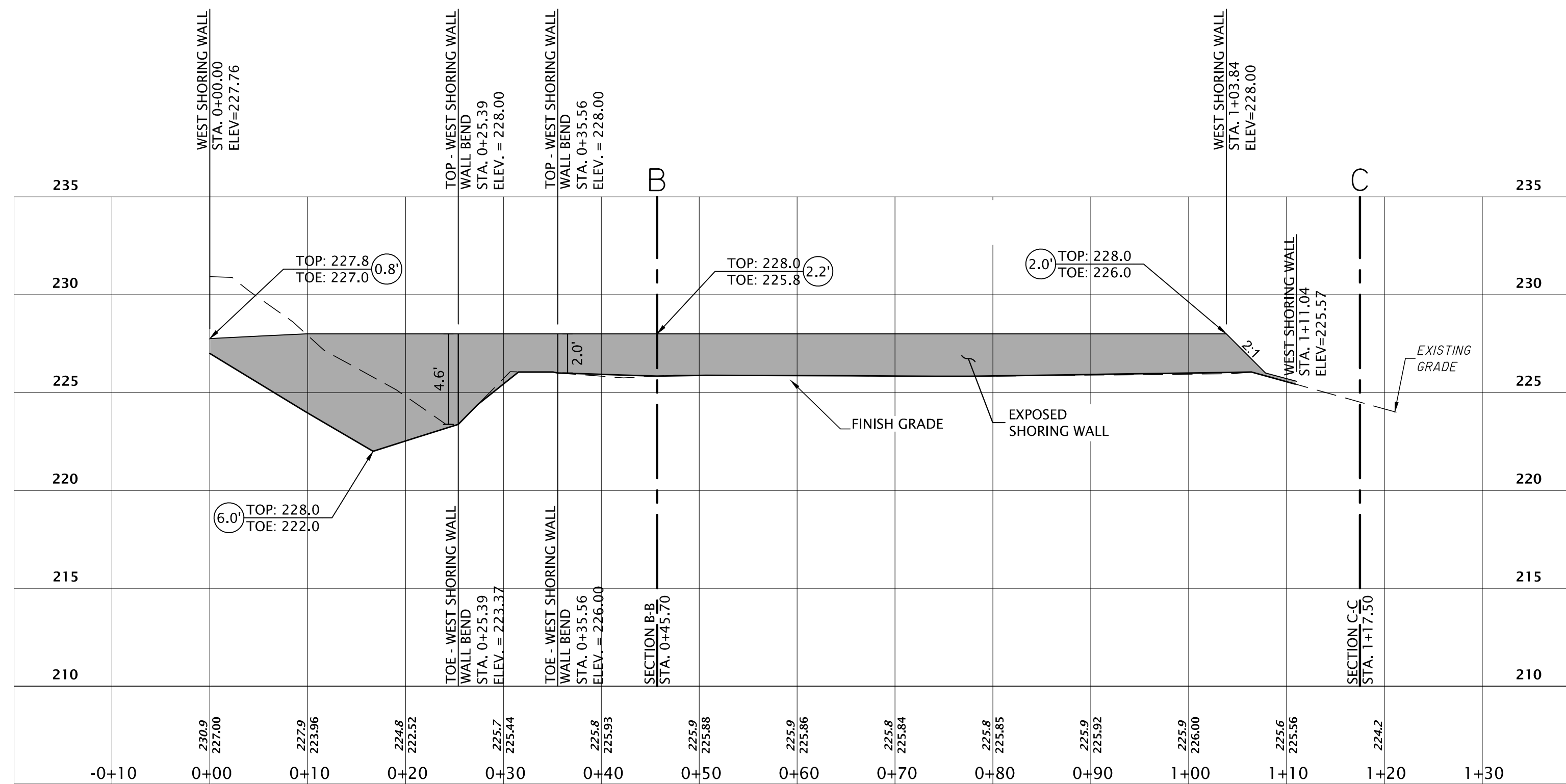

WEST SHORING WALL PROFILE
STA. -0+10.00 TO STA. 1+30.00
1" = 10.00' HORIZ.
1" = 5.00' VERT.

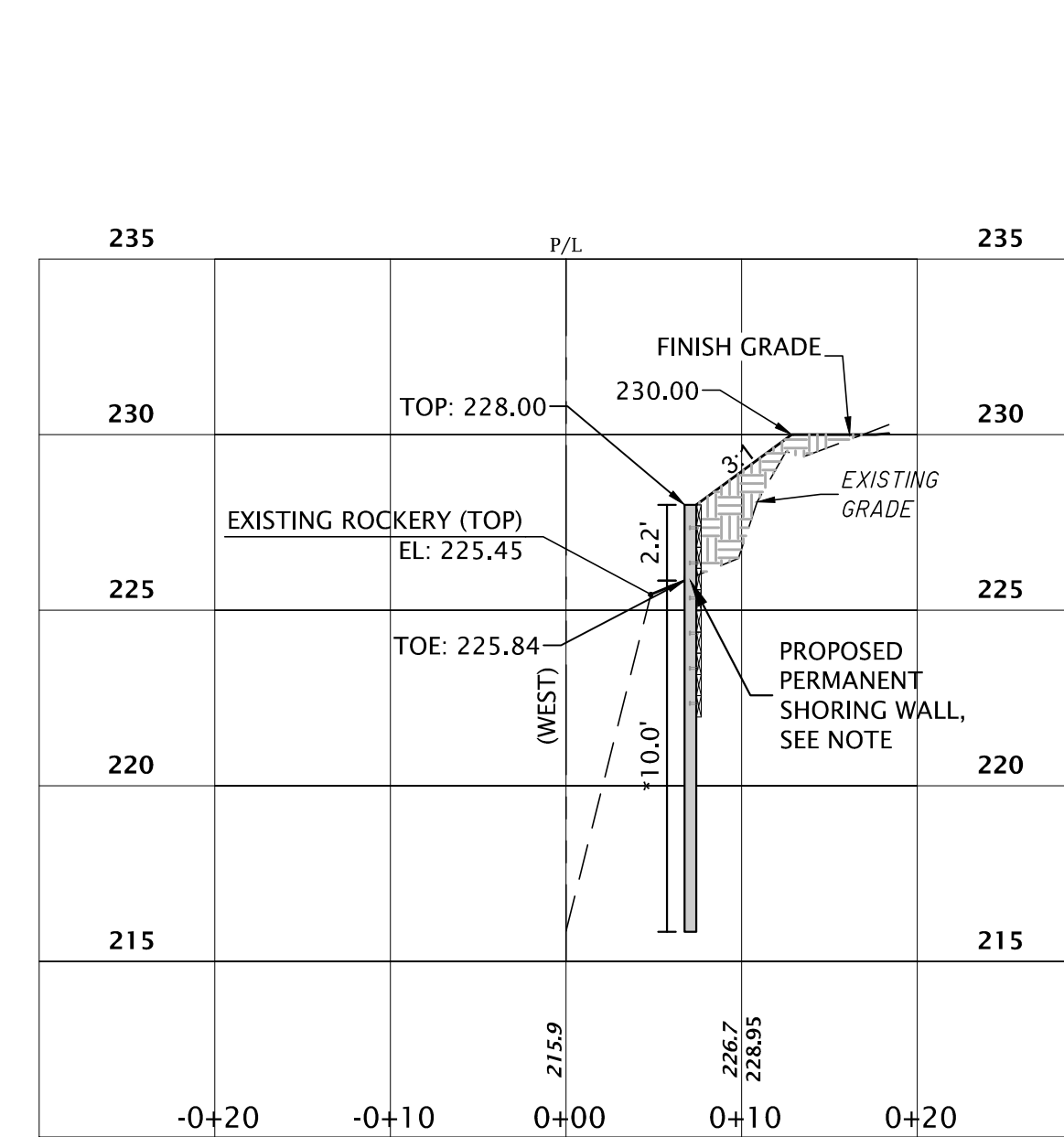

WEST SHORING WALL SECTION B-B PROFILE
STA. -0+20.00 TO STA. 0+20.00
1" = 10.00' HORIZ.
1" = 5.00' VERT.

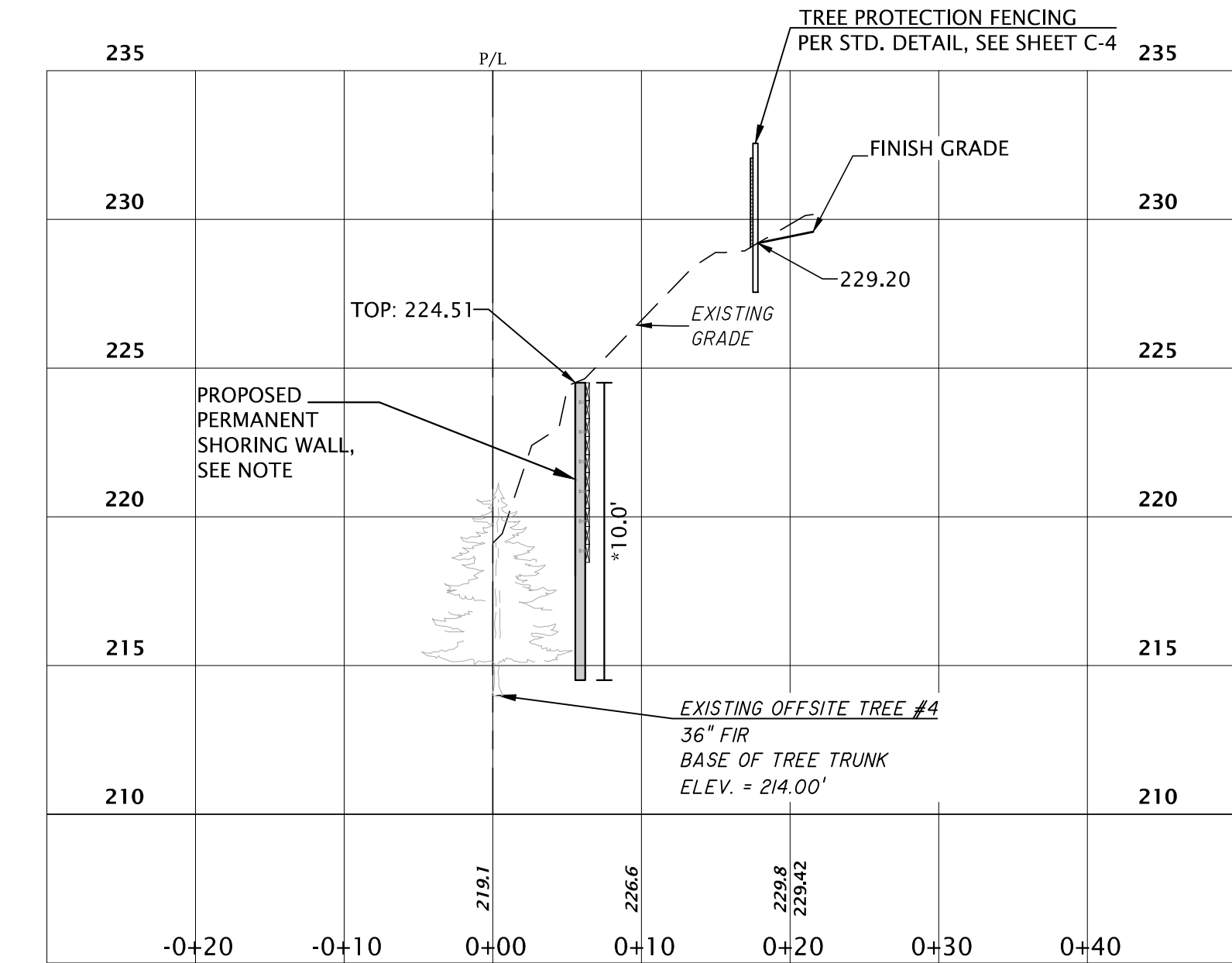

WEST SHORING WALL SECTION C-C PROFILE
STA. -0+20.00 TO STA. 0+40.00
1" = 10.00' HORIZ.
1" = 5.00' VERT.

PERMANENT SHORING WALL NOTES:
*MINIMUM EMBED WALL DEPTH = 10 FEET
REFERENCE PERMANENT SHORING PLANS

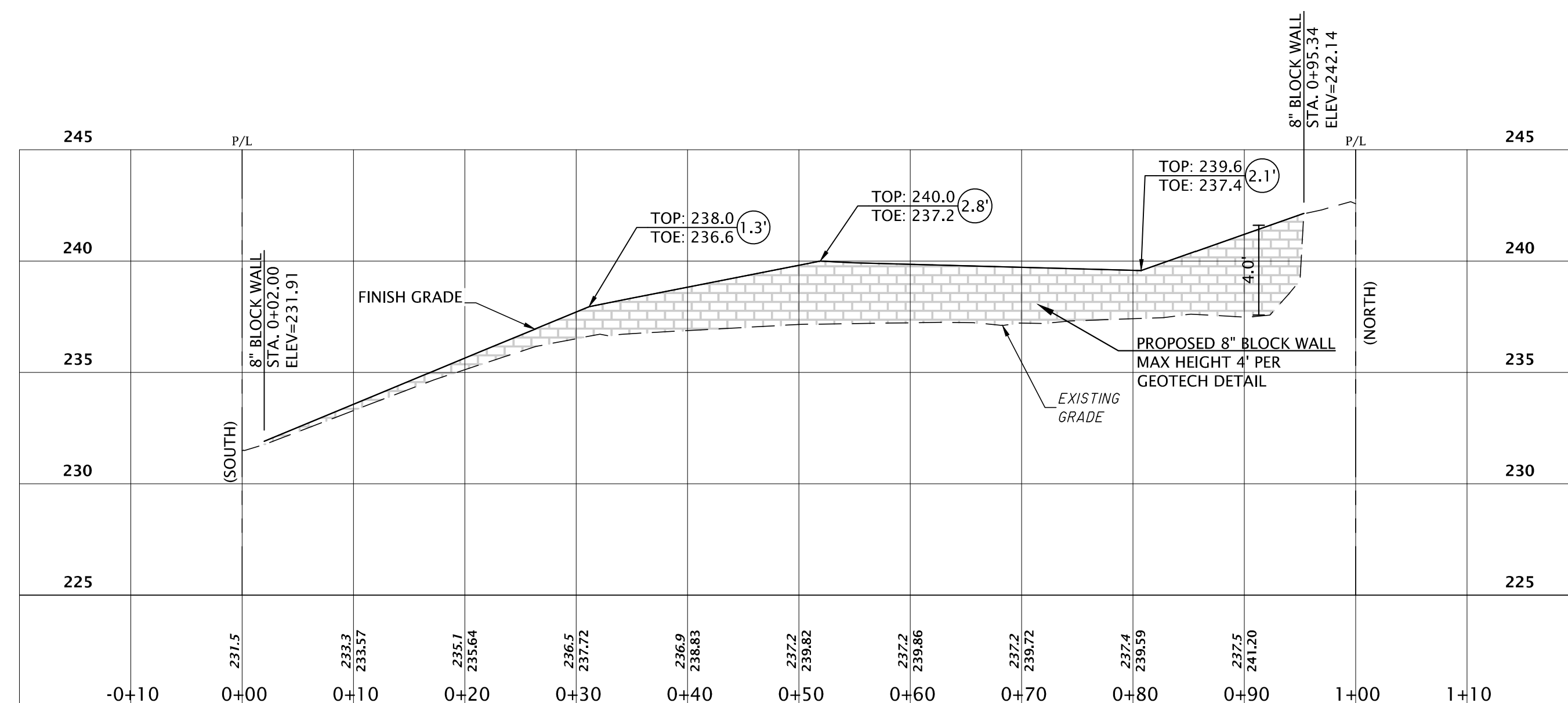

EAST PROPERTY LINE PROFILE
STA. -0+10.00 TO STA. 1+10.00
1" = 10.00' HORIZ.
1" = 5.00' VERT.

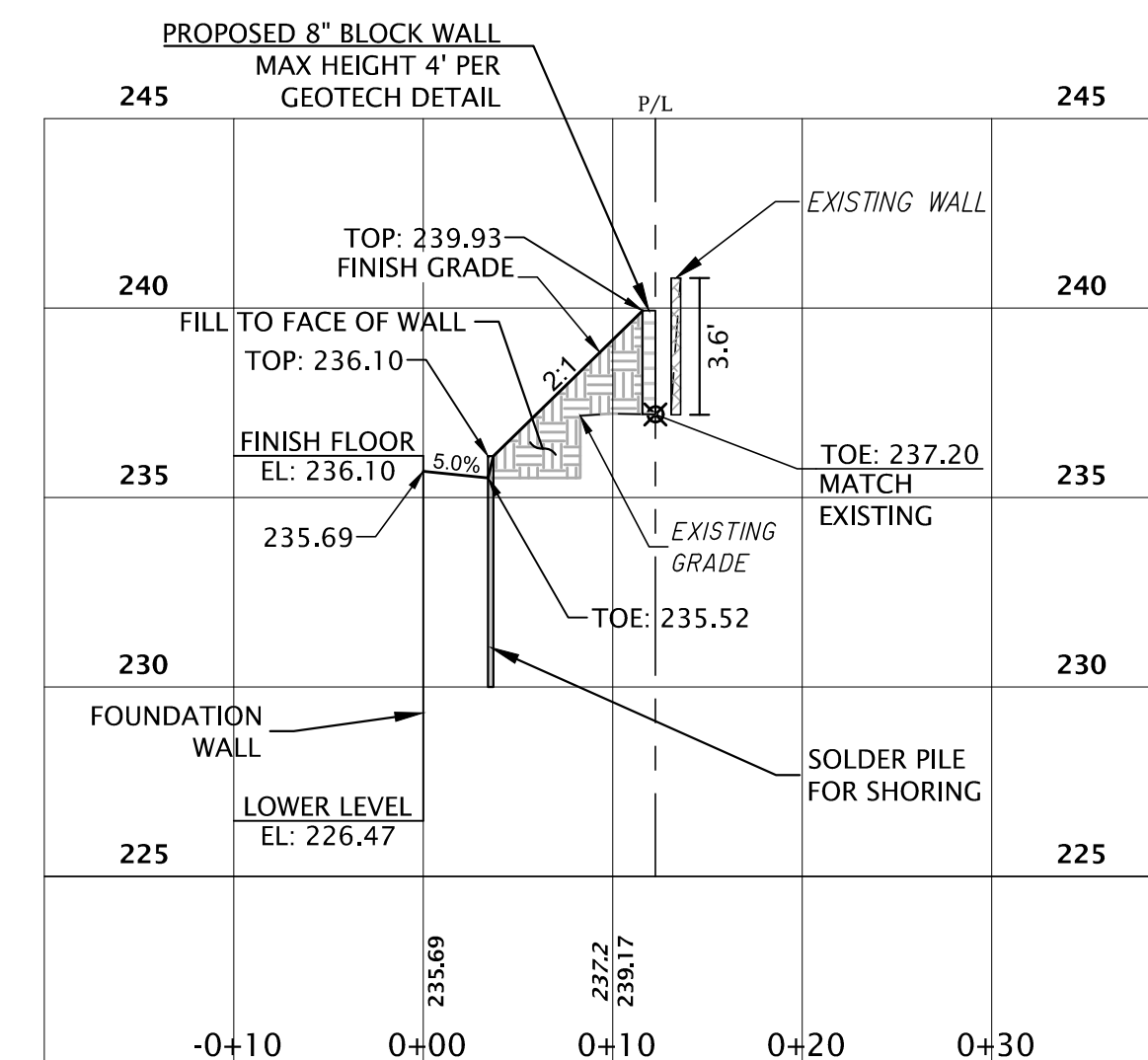

WALL SECTION A-A PROFILE
STA. -0+10.00 TO STA. 0+30.00
1" = 10.00' HORIZ.
1" = 5.00' VERT.

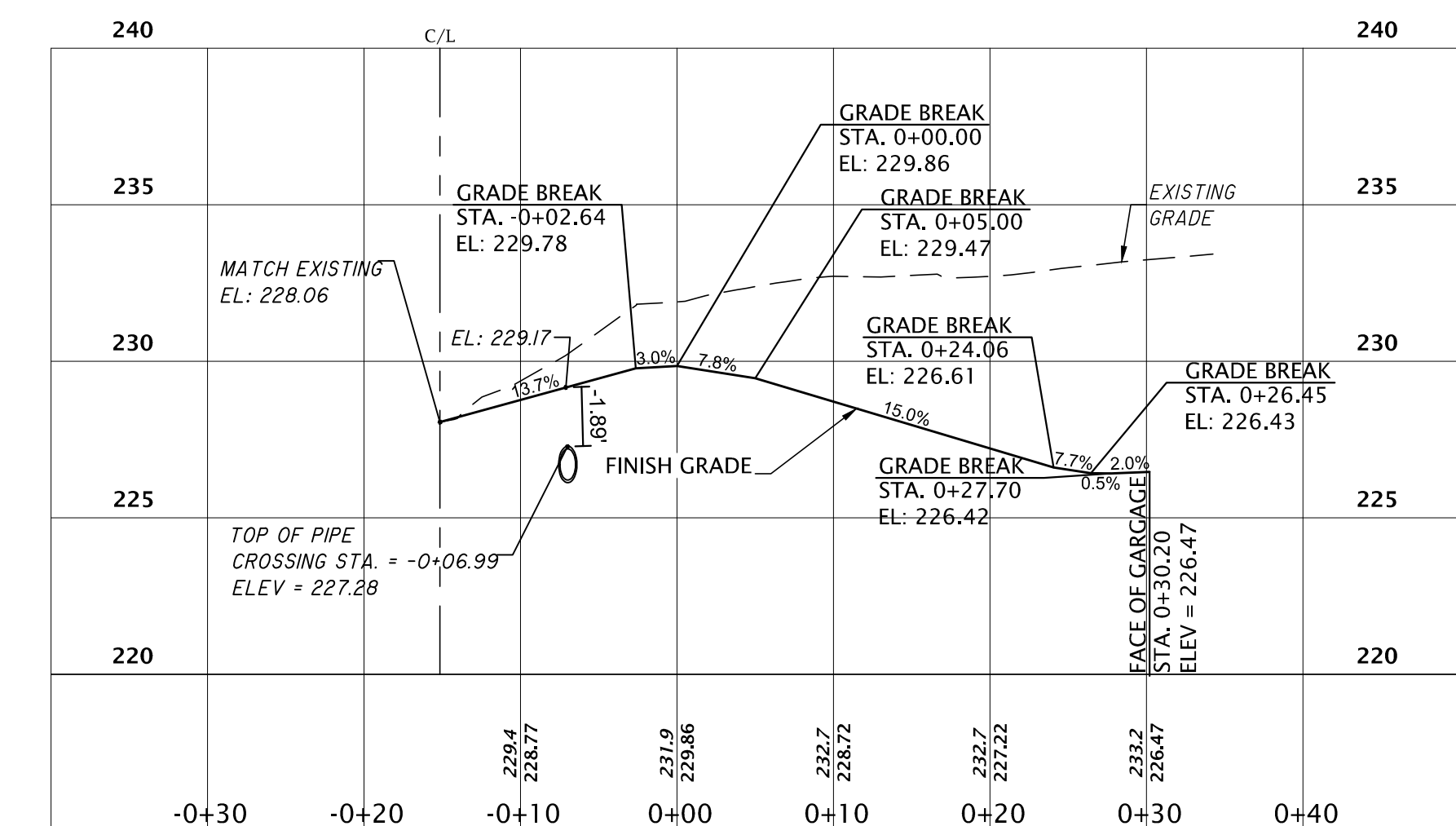

PROPOSE DRIVEWAY PROFILE
STA. -0+30.00 TO STA. 0+40.00
1" = 10.00' HORIZ.
1" = 5.00' VERT.



NW ¼, SW ¼ SECTION 12, TOWNSHIP 24 N, RANGE 4 E, W.M.
CITY OF MERCER ISLAND, KING COUNTY, WASHINGTON

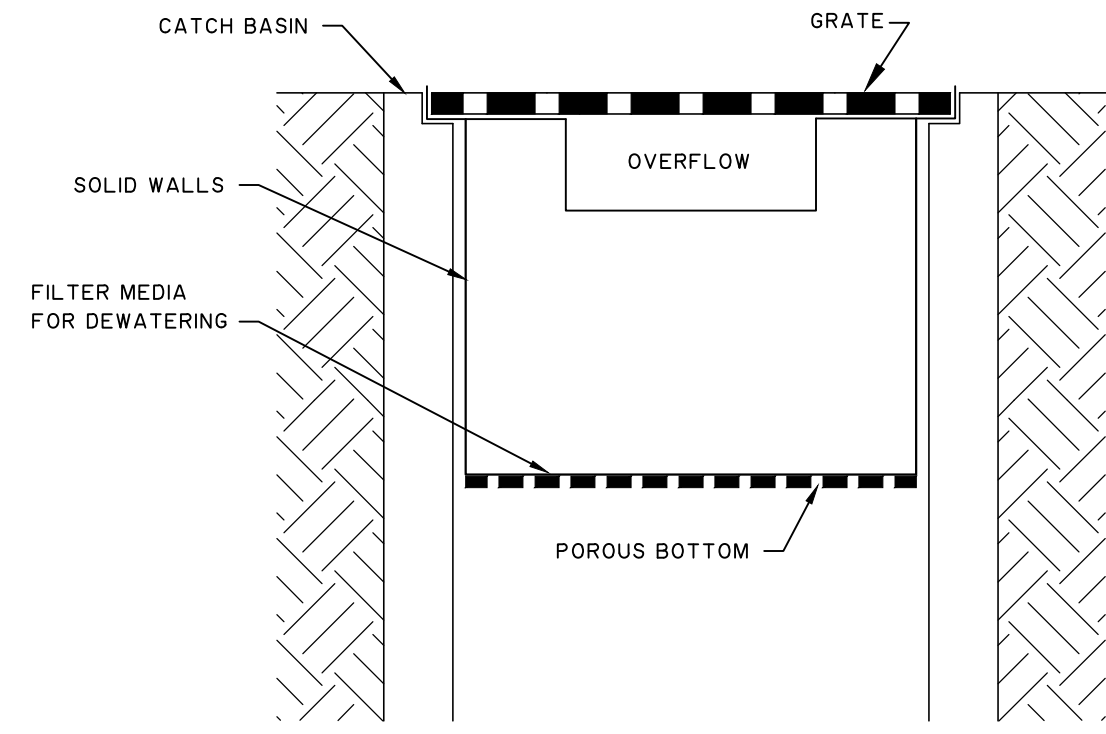

NOTE: THIS DETAIL IS ONLY SCHEMATIC. ANY INSERT IS ALLOWED THAT HAS A MIN. 0.5 C.F. OF STORAGE, THE MEANS TO DEWATER THE STORED SEDIMENT, AN OVERFLOW, AND CAN BE EASILY MAINTAINED.

MAINTENANCE STANDARDS

1. ANY ACCUMULATED SEDIMENT ON OR AROUND THE FILTER FABRIC PROTECTION SHALL BE REMOVED IMMEDIATELY. SEDIMENT SHALL NOT BE REMOVED WITH WATER, AN ALL SEDIMENT MUST BE DISPOSED OF AS FILL ON-SITE OR HAULED OFF-SITE.
2. ANY SEDIMENT IN THE CATCH BASIN INSERT SHALL BE REMOVED WHEN THE SEDIMENT HAS FILLED ONE-THIRD OF THE AVAILABLE STORAGE. THE FILTER MEDIA FOR THE INSERT SHALL BE CLEANED OR REPLACED AT LEAST MONTHLY.
3. REGULAR MAINTENANCE IS CRITICAL FOR BOTH FORMS OF CATCH BASIN PROTECTION. UNLIKE MANY FORMS OF PROTECTION THAT FAIL GRADUALLY, CATCH BASIN PROTECTION WILL FAIL SUDDENLY AND COMPLETELY IF NOT MAINTAINED PROPERLY.

CATCH BASIN INSERT DETAIL

NTS

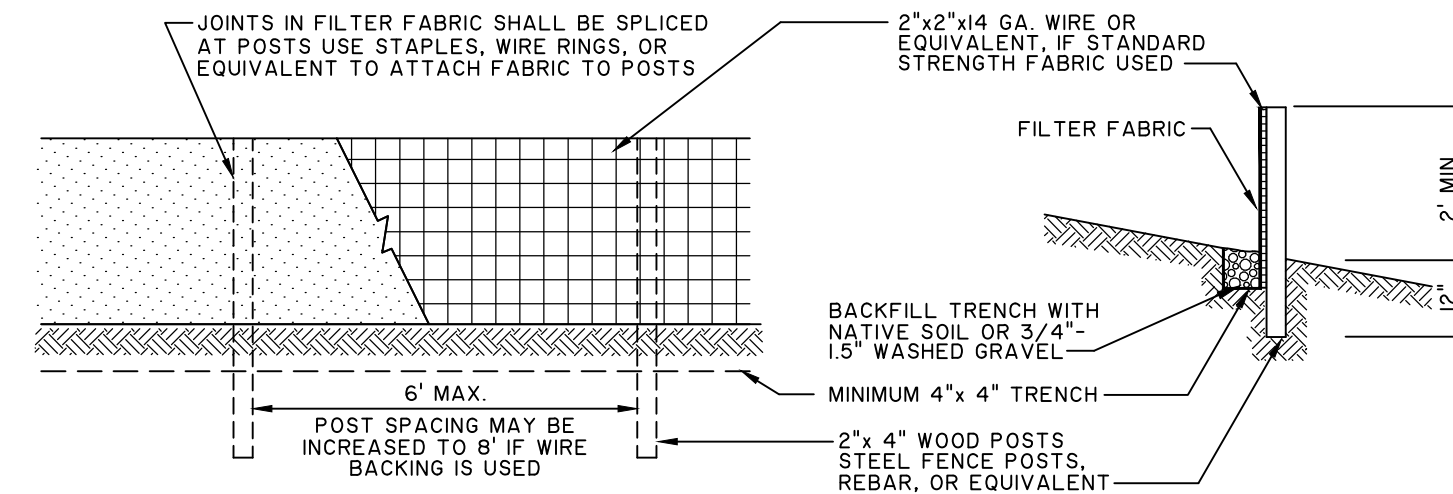

NOTE: FILTER FABRIC FENCES SHALL BE INSTALLED ALONG CONTOUR WHENEVER POSSIBLE.

MAINTENANCE STANDARDS

1. ANY DAMAGE SHALL BE REPAIRED IMMEDIATELY.
2. IF CONCENTRATED FLOWS ARE EVIDENT UPHILL OF THE FENCE, THEY MUST BE INTERCEPTED AND CONVEYED TO A SEDIMENT TRAP OR POND.
3. IT IS IMPORTANT TO CHECK THE UPHILL SIDE OF THE FENCE FOR SIGNS OF THE FENCE CLOGGING AND ACTING AS A BARRIER TO FLOW AND THEN CAUSING CHANNELIZATION OF FLOWS PARALLELED TO THE FENCE. IF THIS OCCURS, REPLACE THE FENCE AND/OR REMOVE THE TRAPPED SEDIMENT.
4. SEDIMENT MUST BE REMOVED WHEN THE SEDIMENT IS 6" HIGH.
5. IF THE FILTER FABRIC HAS DETERIORATED DUE TO ULTRAVIOLET BREAKDOWN, IT SHALL BE REPLACED.

SILT FENCE

NTS

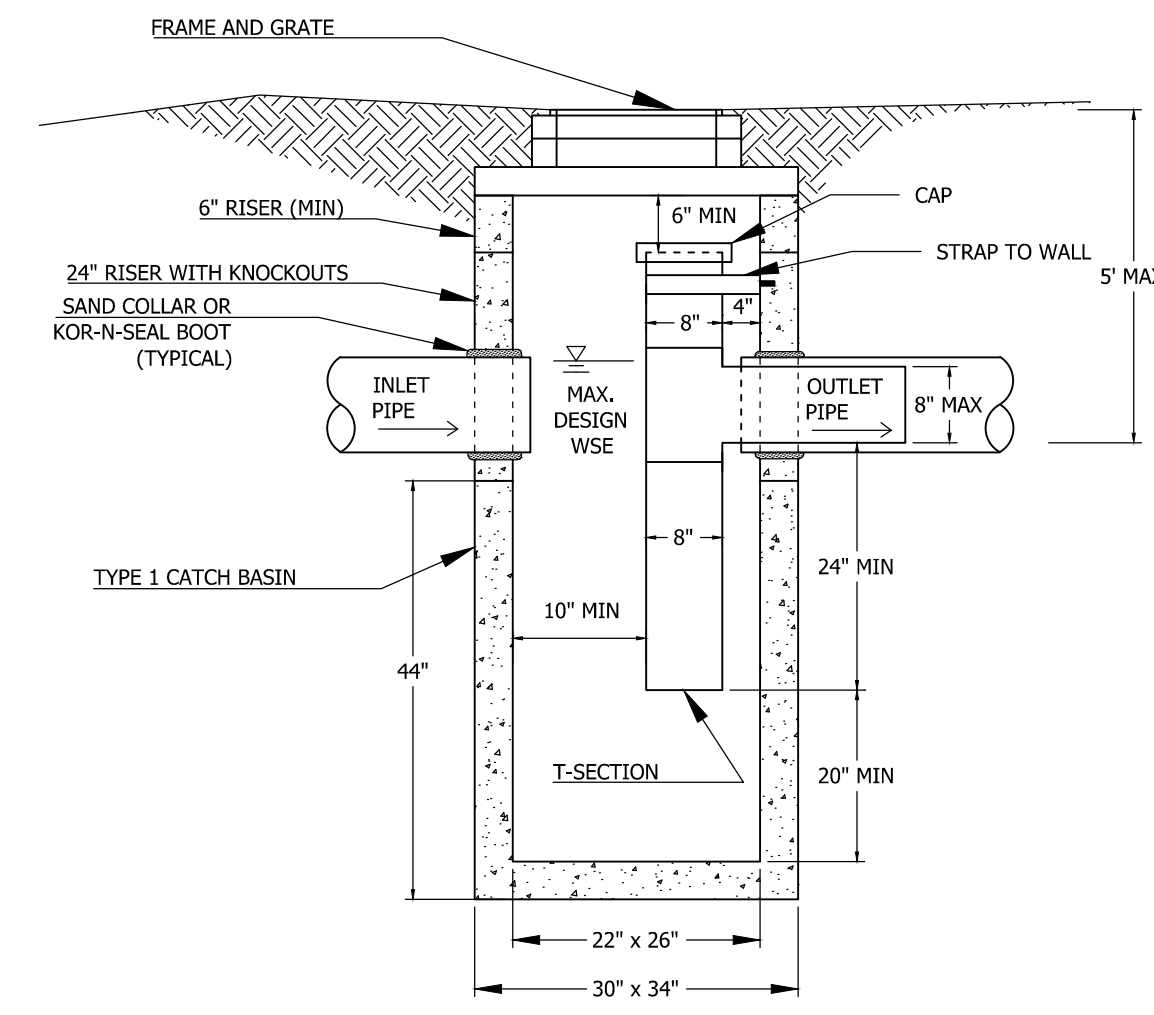

NOTES

1. MAX. OUTLET PIPE DIAMETER IS 8 INCHES. VERTICAL RISER SECTION SHALL BE ALIGNED PLUMB VERTICALLY. HORIZONTAL RISER SECTION SHALL MATCH OUTLET PIPE SLOPE.
2. ALL METAL PARTS AND SURFACES MUST BE CORROSION RESISTANT. STEEL HARDWARE SHALL BE GALVANIZED. PIPES SHALL BE PVC. COMPLETE CORROSION PROTECTION MUST BE ASSURED.
3. APPLY NON-SHRINK GROUT TO INSIDE AND OUTSIDE OF ALL JOINTS, RINGS, RISERS AND FRAMES.
4. SLIP SMOOTH-BORE HORIZONTAL LEG OF FLOW CONTROL TEE INSIDE CARRIER PIPE.
5. NO FLOW CONTROL JOINT OUTSIDE OF STRUCTURE.

CB TYPE 1 W/ OIL & WATER SEPARATOR

NTS

STANDARD TESC PLAN NOTES:

1. APPROVAL OF THIS EROSION/SEDIMENTATION CONTROL (ESC) PLAN DOES NOT CONSTITUTE AN APPROVAL OF PERMANENT ROAD OR DRAINAGE DESIGN (E.G. SIZE AND LOCATION OF ROADS, PIPES, RESTRICTORS, CHANNELS, RETENTION FACILITIES, UTILITIES, ETC.).
2. THE IMPLEMENTATION OF THESE ESC PLANS AND THE CONSTRUCTION, MAINTENANCE, REPLACEMENT, AND UPGRADING OF THESE ESC FACILITIES IS THE RESPONSIBILITY OF THE APPLICANT/CONTRACTOR UNTIL ALL CONSTRUCTION IS COMPLETED AND APPROVED AND VEGETATION/LANDSCAPING IS ESTABLISHED.
3. THE BOUNDARIES OF THE CLEARING LIMITS SHOWN ON THIS PLAN SHALL BE CLEARLY FLAGGED IN THE FIELD PRIOR TO CONSTRUCTION. DURING THE CONSTRUCTION PERIOD, NO DISTURBANCE BEYOND THE FLAGGED CLEARING LIMITS SHALL BE PERMITTED. THE FLAGGING SHALL BE MAINTAINED BY THE APPLICANT/CONTRACTOR FOR THE DURATION OF CONSTRUCTION.
4. THE ESC FACILITIES SHOWN ON THIS PLAN MUST BE CONSTRUCTED IN CONJUNCTION WITH ALL CLEARING AND GRADING ACTIVITIES, AND IN SUCH A MANNER AS TO INSURE THAT SEDIMENT AND SEDIMENT LADEN WATER DO NOT ENTER THE DRAINAGE SYSTEM, ROADWAYS, OR VIOLATE APPLICABLE WATER STANDARDS.
5. THE ESC FACILITIES SHOWN ON THIS PLAN ARE THE MINIMUM REQUIREMENTS FOR ANTICIPATED SITE CONDITIONS. DURING THE CONSTRUCTION PERIOD, THESE ESC FACILITIES SHALL BE UPGRADED AS NEEDED FOR UNEXPECTED STORM EVENTS AND TO ENSURE THAT SEDIMENT AND SEDIMENT-LADEN WATER DO NOT LEAVE THE SITE.
6. THE ESC FACILITIES SHALL BE INSPECTED DAILY BY THE APPLICANT/CONTRACTOR AND MAINTAINED AS NECESSARY TO ENSURE THEIR CONTINUED FUNCTIONING.
7. THE ESC FACILITIES ON INACTIVE SITES SHALL BE INSPECTED AND MAINTAINED A MINIMUM OF ONCE A MONTH OR WITHIN THE 48 HOURS FOLLOWING A MAJOR STORM EVENT.
8. AT NO TIME SHALL MORE THAN ONE FOOT OF SEDIMENT BE ALLOWED TO ACCUMULATE WITHIN A TRAPPED CATCH BASIN. ALL CATCH BASINS AND CONVEYANCE LINES SHALL BE CLEANED PRIOR TO PAVING. THE CLEANING OPERATION SHALL NOT FLUSH SEDIMENT LADEN WATER INTO THE DOWNSTREAM SYSTEM.
9. STABILIZED CONSTRUCTION ENTRANCES SHALL BE INSTALLED AT THE BEGINNING OF CONSTRUCTION AND MAINTAINED FOR THE DURATION OF THE PROJECT. ADDITIONAL MEASURES MAY BE REQUIRED TO INSURE THAT ALL PAVED AREAS ARE KEPT CLEAN FOR THE DURATION OF THE PROJECT.

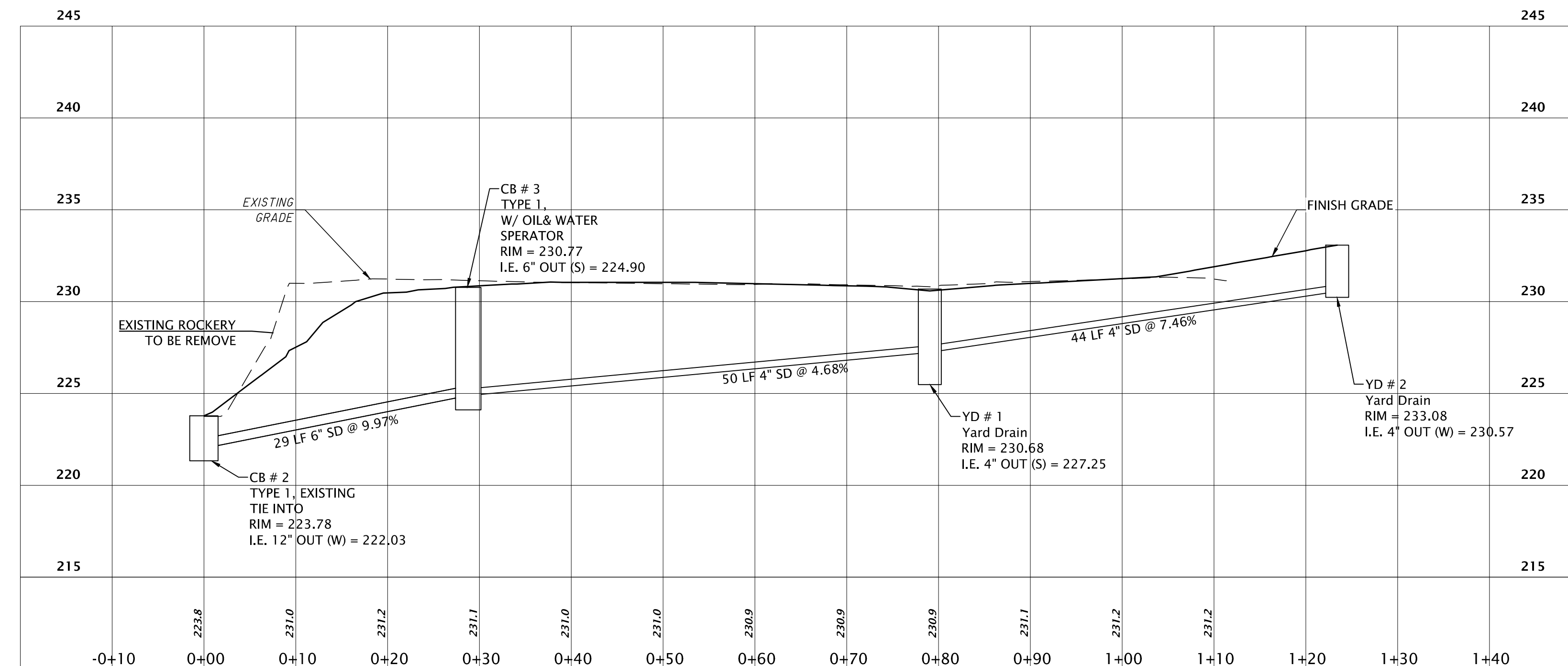

PROPOSE RESIDENTIAL STORM DRAIN CONNECTION PROFILE

STA. -0+10.00 TO STA. 1+40.00
1"=10.00' HORIZ.
1"=5.00' VERT.

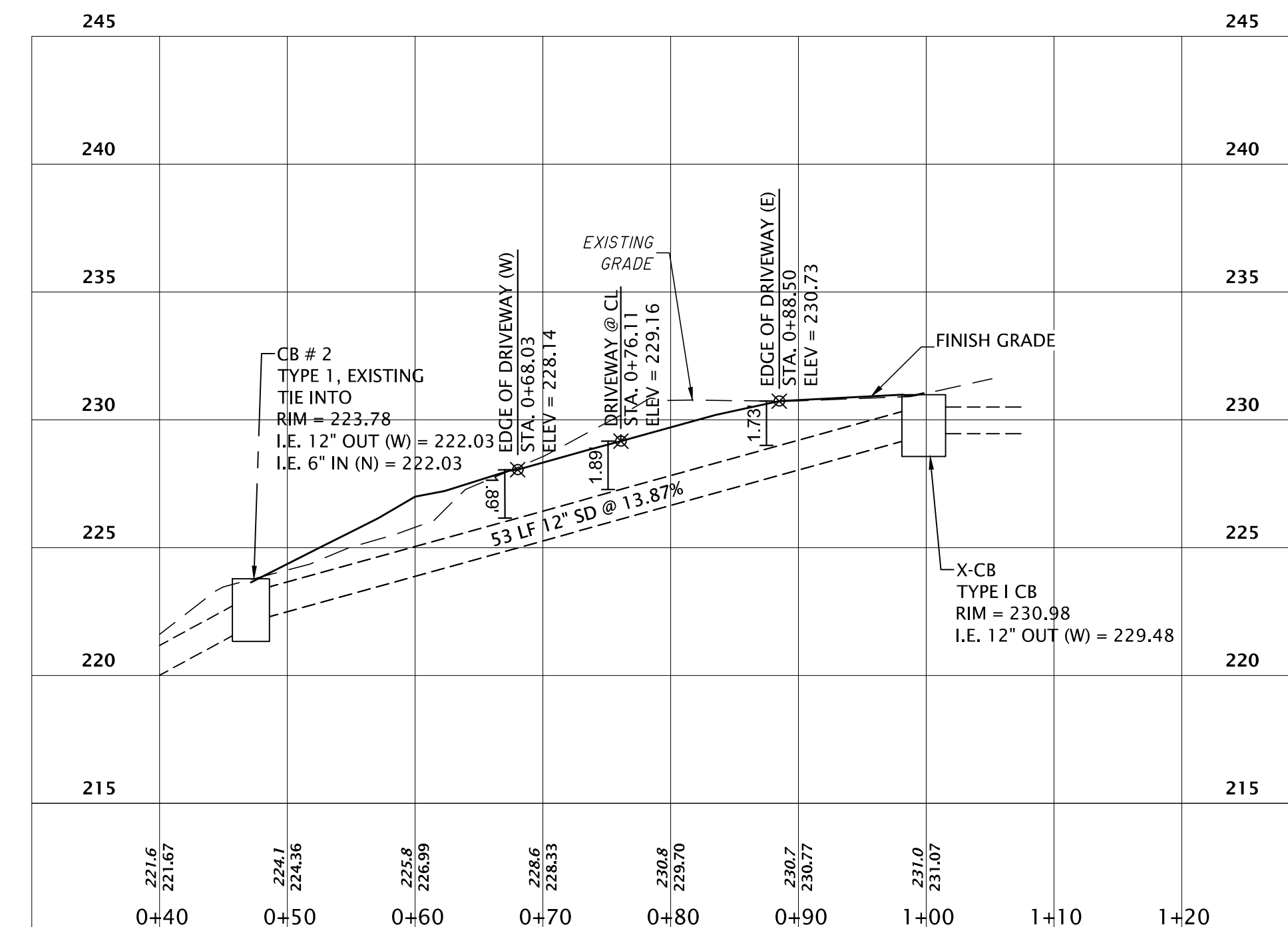

EXISTING SE MARKER ST. STORM PROFILE

STA. 0+40.00 TO STA. 1+20.00
1"=10.00' HORIZ.
1"=5.00' VERT.



PLAN NOTES:

- THIS PROJECT SHALL BE DESIGNED, ENGINEERED, + CONSTRUCTED IN FULL COMPLIANCE W/ ALL CODES + REGULATIONS.
- ALL EXTERIOR WALLS SHALL BE 2x6 UNO.
- ALL INTERIOR WALLS SHALL BE 2x4 UNO.
- ALL HANDRAILS SHALL BE LOCATED @ 36" ABOVE STAIR NOSING WITH A GRASP DIMENSION BETWEEN 1 1/8" - 2".
- ALL HANDRAILS SHALL BE CONTINUOUS OR TERMINATE AT NEWEL POST.
- ALL GUARDRAILS SHALL BE 36" ABOVE FINISHED FLOOR AND DESIGNED SUCH THAT THE MAXIMUM OPENING WILL NOT ALLOW PASSAGE OF A 4" SPHERE.
- ALL GUARDRAILS SHALL BE DESIGNED TO RESIST A 200LB CONCENTRATED LOAD AT THE TOP RAIL AND 50 PSF ON ALL GUARDRAIL INFILL COMPONENTS.
- 5/8" TYPE 'X' GWB AT ALL GARAGE WALLS AND CEILING AS WELL AS ANY POSTS + BEAMS.
- ACCESSIBLE AREA UNDER STAIR SHALL BE 1/2" GWB MINIMUM.
- PROVIDE A PROGRAMMABLE THERMOSTAT FOR THE PRIMARY SPACE CONDITIONING SYSTEM WITHIN EACH DWELLING UNIT PER SEC R403.11.
- A MINIMUM OF 75 PERCENT OF PERMANENTLY INSTALLED LAMPS IN LIGHTING FIXTURES SHALL BE HIGH-EFFICACY LAMPS.
- ALL SHOWERHEADS + KITCHEN SINK FAUCETS INSTALLED IN THE UNIT SHALL BE RATED AT 1.75 GPM OR LESS. ALL OTHER LAVATORY FAUCETS SHALL BE RATED AT 1.0 GPM OR LESS.
- ALL EXHAUST AIR SHALL VENT DIRECTLY TO THE EXTERIOR OF THE BUILDING PER M501.1 AND M506.2.
- ALL NEW STAIRS SHALL MEET THE FOLLOWING REQUIREMENTS:
 - MINIMUM 36" WIDTH.
 - MAXIMUM 7 3/4" RISER, MINIMUM 10" TREAD.
 - MINIMUM 6'-8" HEAD ROOM.
 - MINIMUM LANDING LENGTH 36"
- CONTRACTOR TO COMPLETE AND POST INSULATION CERTIFICATE FOR RESIDENTIAL CONSTRUCTION FORM WITHIN 3' OF ELECTRICAL PANEL PRIOR TO FINAL INSPECTION.
- WINDOW AND DOOR HEADERS SHALL BE INSULATED WITH A MINIMUM R-10 INSULATION.
- SHOULD AN AIR LEAKAGE TEST BE CONDUCTED, A WRITTEN REPORT OF THE AIR LEAKAGE TEST RESULTS SHALL BE SIGNED BY THE TESTING PARTY AND PROVIDED TO THE BUILDING INSPECTOR PRIOR TO CALL FOR FINAL INSPECTION. AIR LEAKAGE SHALL NOT EXCEED 5 AIR CHANGES/HOUR.
- WHOLE HOUSE VENTILATION INTEGRATED WITH FORCED-AIR SYSTEM PER SRC M507.3.5 AND SHALL RUN INTERMITTENTLY.

WSEC 2018 NOTES:

- THIS PROJECT IS ELIGIBLE AND COMPLIANT W/ WSEC 2018 PRESCRIPTIVE METHOD.
- INSULATION VALUES SHALL BE AS FOLLOWS:
 - ALL VERTICAL GLAZING SHALL BE 0.30 U-FACTOR MAX.
 - ALL OVERHEAD GLAZING SHALL BE 0.50 U-FACTOR MAX.
 - ALL EXTERIOR DOORS (INCLUDING DOORS FROM CONDITIONED SPACE TO UNCONDITIONED SPACE) SHALL BE 0.20 U-FACTOR MIN.
 - ALL CEILINGS OVER UNCONDITIONED SPACE SHALL RECEIVE R-49 BLOWN-IN INSULATION MIN.
 - ALL VAULTED CEILINGS SHALL RECEIVE R-38 BATT INSULATION MIN.
 - ALL ABOVE-GRADE EXTERIOR WALLS SHALL RECEIVE R-21 BATT INSULATION MIN.
 - ALL BELOW-GRADE EXTERIOR WALLS SHALL RECEIVE R-21 BATT INSULATION MIN @ INTERIOR FRAMED WALL.
 - ALL FLOORS OVER UNCONDITIONED SPACE SHALL RECEIVE R-30 BATT INSULATION MIN.
 - ALL SLAB-ON-GRADE WITHIN CONDITIONED SPACE SHALL RECEIVE R-10 RIGID INSULATION WITHIN 24" OF SLAB PERIMETER.
 - ALL HEADERS @ EXTERIOR WALLS SHALL RECEIVE R-10 RIGID INSULATION @ INTERIOR SIDE OF WALL.
- RE: STRUCTURAL DRAWINGS FOR ALL FRAMING COMPLIANCE REQUIREMENTS.
- PROVIDE 100 CFM INTERMITTENTLY OPERATING POINT-OF-USE VENTILATION @ KITCHEN.
- PROVIDE 50 CFM INTERMITTENTLY OPERATING POINT-OF-USE VENTILATION @ ALL BATHS + LAUNDRY.
- NATURAL GAS, PROPANE OR OIL WATER HEATER SHALL HAVE A MINIMUM EF OF 0.91 (WSEC 406.2, CREDIT 5a).
- AT CRAWL SPACES THE MIN NET AREA OF VENTILATION OPENINGS SHALL NOT BE LESS THAN 1 FT² FOR EACH 300 FT² OF UNDER-FLOOR AREA. ONE VENTILATION OPENING SHALL BE WITHIN 3'-0" OF EACH CORNER OF THE BUILDING AT CRAWLSPACE. EXCEPT ONE SIDE OF THE BUILDING SHALL BE PERMITTED TO HAVE NO VENTILATION OPENINGS, OR CRAWLSPACE SHALL BE MECHANICALLY VENTED.
- THE BUILDING THERMAL ENVELOPE SHALL BE CONSTRUCTED TO LIMIT AIR LEAKAGE IN ACCORDANCE WITH THE REQUIREMENTS OF SECTIONS R402.4.1 THROUGH R402.4.4. WHERE REQUIRED BY THE CODE OFFICIAL, TESTING SHALL BE CONDUCTED BY AN APPROVED THIRD PARTY AND A WRITTEN REPORT OF THE TESTING RESULTS SHALL BE SIGNED BY THE TESTING PARTY AND PROVIDED TO THE CODE OFFICIAL.
- AT LEAST ONE THERMOSTAT PER DWELLING UNIT SHALL BE CAPABLE OF CONTROLLING THE HEATING AND COOLING SYSTEM ON A DAILY SCHEDULE.

FLOOR AREAS:

LOT AREA:	8,750 FT ²
MAXIMUM ALLOWABLE GFA:	(40%) 3,500 FT ²
ADDITIONAL GFA FOR ADU:	(5%) 437.5 FT ²
TOTAL ALLOWABLE GFA W/ ADU:	(45%) 3,937.5 FT ²
MAIN RESIDENCE BASEMENT GFA:	[528 FT ²]
(INCLUDES STAIRS TO MAIN LEVEL: 81 FT ²)	
ELEVATOR SHAFT @ BASEMENT:	[20 FT ²]
GARAGE GFA:	[476 FT ²]
BASEMENT ADU GFA:	[586 FT ²]
BASEMENT SUBTOTAL:	[1,610 FT²]
(937.5 FT ² EXCLUDED SEE BELOW):	672 FT ²
FIRST FLOOR GFA:	1649 FT ²
(EXCLUDE STAIR PER 19.02.020.D.2.c):	(81 FT ²)
ELEVATOR SHAFT:	20 FT ²
SECOND FLOOR GFA:	1529 FT ²
(EXCLUDE ELEVATOR SHAFT):	(20 FT ²)
SECOND FLOOR COVERED DECK GFA:	66 FT ²
TOTAL GROSS FLOOR AREA:	(44.9%) 3,936 FT ²

BASEMENT FLOOR EXCLUSION CALCS:

WALL SEGMENT	LENGTH	COVERAGE %	RESULT
A	35'	0%	0'
B	46'	59.37%	27'-3"
C	35'	60.42%	21'-1"
D	46'	100%	46'-0"
TOTALS	162'		94'-4"

94'-4" / 162' = 58.23%

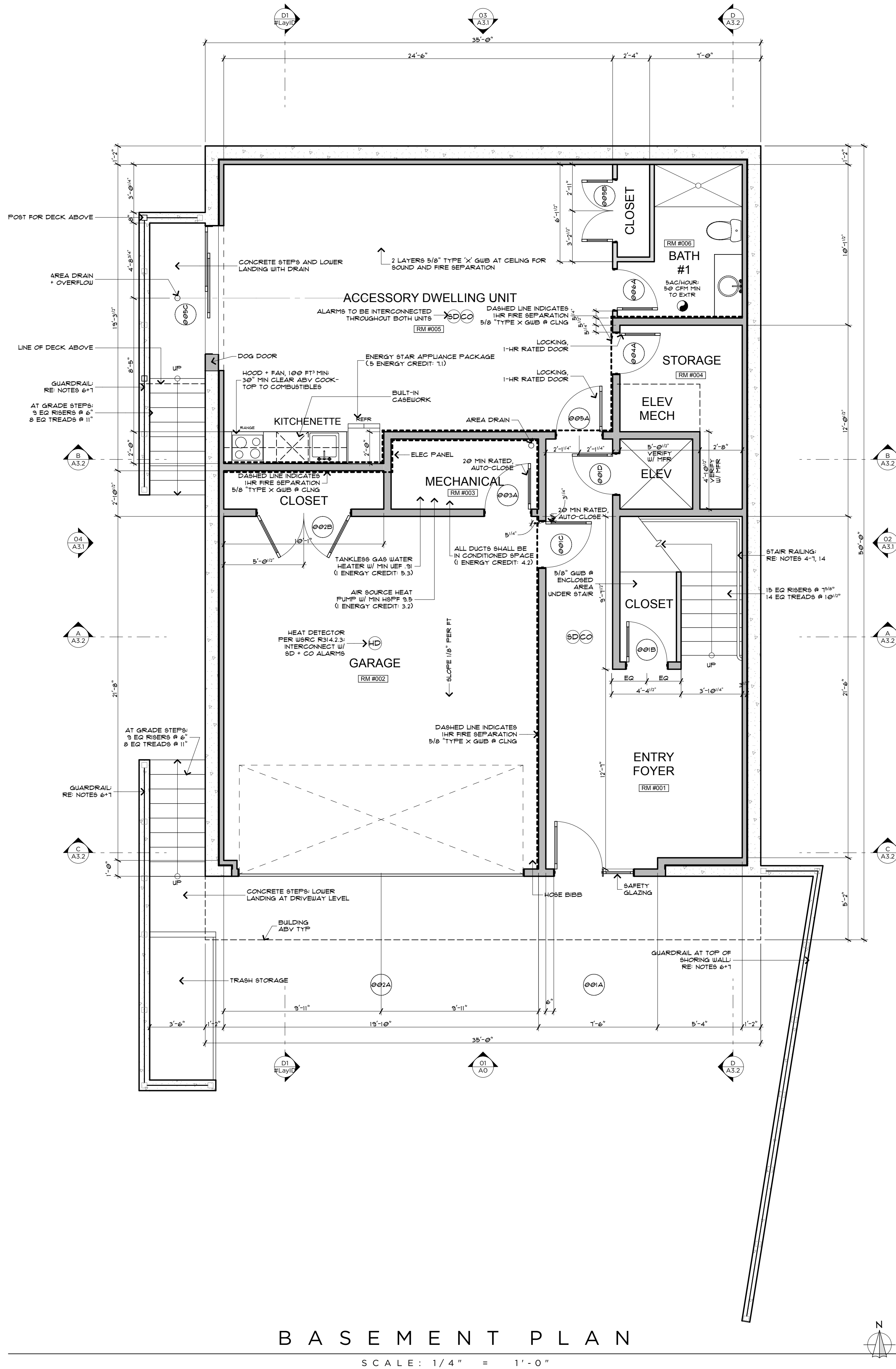
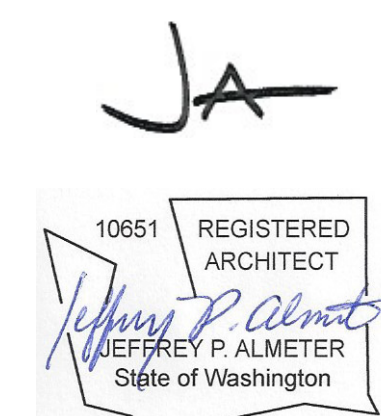

BASEMENT PLAN

SCALE: 1/4" = 1'-0"

10651 REGISTERED ARCHITECT
Jeffrey P. Almeter
 JEFFREY P. ALMETER
 State of Washington
 6950 SE MAKER ST
 MERCER ISLAND, WA

BASEMENT FLOOR PLAN
 RELEASE
 21 MARCH 2022
 PERMIT CORRECTIONS
 20 FEBRUARY 2023
 PERMIT CORRECTIONS
 2 JUNE 2023

A 2.0

MAKER AVE
PHOTOGRAPH BY J. P. ALMETER

PLAN NOTES:

- THIS PROJECT SHALL BE DESIGNED, ENGINEERED, + CONSTRUCTED IN FULL COMPLIANCE W/ ALL CODES + REGULATIONS.
- ALL EXTERIOR WALLS SHALL BE 2x6 UNO.
- ALL INTERIOR WALLS SHALL BE 2x4 UNO.
- ALL HANDRAILS SHALL BE LOCATED @ 36" ABOVE STAIR NOSING WITH A GRASP DIMENSION BETWEEN 1 1/4" - 2".
- ALL HANDRAILS SHALL BE CONTINUOUS OR TERMINATE AT NEWEL POST.
- ALL GUARDRAILS SHALL BE 36" ABOVE FINISHED FLOOR AND DESIGNED SUCH THAT THE MAXIMUM OPENING WILL NOT ALLOW PASSAGE OF A 4" SPHERE.
- ALL GUARDRAILS SHALL BE DESIGNED TO RESIST A 200LB CONCENTRATED LOAD AT THE TOP RAIL AND 50 PSF ON ALL GUARDRAIL INFILL COMPONENTS.
- 5/8" TYPE 'X' GWB AT ALL GARAGE WALLS AND CEILING AS WELL AS ANY POSTS + BEAMS.
- ACCESSIBLE AREA UNDER STAIR SHALL BE 1/2" GWB MINIMUM.
- PROVIDE A PROGRAMMABLE THERMOSTAT FOR THE PRIMARY SPACE CONDITIONING SYSTEM WITHIN EACH DWELLING UNIT PER SEC R403.11.
- A MINIMUM OF 75 PERCENT OF PERMANENTLY INSTALLED LAMPS IN LIGHTING FIXTURES SHALL BE HIGH-EFFICACY LAMPS.
- ALL SHOWERHEADS + KITCHEN SINK FAUCETS INSTALLED IN THE UNIT SHALL BE RATED AT 1.75 GPM OR LESS. ALL OTHER LAVATORY FAUCETS SHALL BE RATED AT 1.0 GPM OR LESS.
- ALL EXHAUST AIR SHALL VENT DIRECTLY TO THE EXTERIOR OF THE BUILDING PER M501.1 AND M506.2.
- ALL NEW STAIRS SHALL MEET THE FOLLOWING REQUIREMENTS:
 - MINIMUM 36" WIDTH.
 - MAXIMUM 7 3/4" RISER, MINIMUM 10" TREAD.
 - MINIMUM 6'-8" HEAD ROOM.
 - MINIMUM LANDING LENGTH 36"
- CONTRACTOR TO COMPLETE AND POST INSULATION CERTIFICATE FOR RESIDENTIAL CONSTRUCTION FORM WITHIN 3' OF ELECTRICAL PANEL PRIOR TO FINAL INSPECTION.
- WINDOW AND DOOR HEADERS SHALL BE INSULATED WITH A MINIMUM R-10 INSULATION.
- SHOULD AN AIR LEAKAGE TEST BE CONDUCTED, A WRITTEN REPORT OF THE AIR LEAKAGE TEST RESULTS SHALL BE SIGNED BY THE TESTING PARTY AND PROVIDED TO THE BUILDING INSPECTOR PRIOR TO CALL FOR FINAL INSPECTION. AIR LEAKAGE SHALL NOT EXCEED 5 AIR CHANGES/HOUR.
- WHOLE HOUSE VENTILATION INTEGRATED WITH FORCED-AIR SYSTEM PER SRC M507.3.5 AND SHALL RUN INTERMITTENTLY.

WSEC 2018 NOTES:

- THIS PROJECT IS ELIGIBLE AND COMPLIANT W/ WSEC 2018 PRESCRIPTIVE METHOD.
- INSULATION VALUES SHALL BE AS FOLLOWS:
 - ALL VERTICAL GLAZING SHALL BE 0.30 U-FACTOR MAX.
 - ALL OVERHEAD GLAZING SHALL BE 0.50 U-FACTOR MAX.
 - ALL EXTERIOR DOORS (INCLUDING DOORS FROM CONDITIONED SPACE TO UNCONDITIONED SPACE) SHALL BE 0.20 U-FACTOR MIN.
 - ALL CEILINGS OVER UNCONDITIONED SPACE SHALL RECEIVE R-49 BLOWN-IN INSULATION MIN.
 - ALL VAULTED CEILINGS SHALL RECEIVE R-38 BATT INSULATION MIN.
 - ALL ABOVE-GRADE EXTERIOR WALLS SHALL RECEIVE R-21 BATT INSULATION MIN.
 - ALL BELOW-GRADE EXTERIOR WALLS SHALL RECEIVE R-21 BATT INSULATION MIN @ INTERIOR FRAMED WALL.
 - ALL FLOORS OVER UNCONDITIONED SPACE SHALL RECEIVE R-30 BATT INSULATION MIN.
 - ALL SLAB-ON-GRADE WITHIN CONDITIONED SPACE SHALL RECEIVE R-10 RIGID INSULATION WITHIN 24" OF SLAB PERIMETER.
 - ALL HEADERS @ EXTERIOR WALLS SHALL RECEIVE R-10 RIGID INSULATION @ INTERIOR SIDE OF WALL.
- RE: STRUCTURAL DRAWINGS FOR ALL FRAMING COMPLIANCE REQUIREMENTS.
- PROVIDE 100 CFM INTERMITTENTLY OPERATING POINT-OF-USE VENTILATION @ KITCHEN.
- PROVIDE 50 CFM INTERMITTENTLY OPERATING POINT-OF-USE VENTILATION @ ALL BATHS + LAUNDRY.
- NATURAL GAS, PROPANE OR OIL WATER HEATER SHALL HAVE A MINIMUM EF OF 0.91 (WSEC 406.2, CREDIT 5c).
- AT CRAWL SPACES THE MIN NET AREA OF VENTILATION OPENINGS SHALL NOT BE LESS THAN 1 FT² FOR EACH 300 FT² OF UNDER-FLOOR AREA. ONE VENTILATION OPENING SHALL BE WITHIN 3'-0" OF EACH CORNER OF THE BUILDING AT CRAWLSPACE. EXCEPT ONE SIDE OF THE BUILDING SHALL BE PERMITTED TO HAVE NO VENTILATION OPENINGS, OR CRAWLSPACE SHALL BE MECHANICALLY VENTED.
- THE BUILDING THERMAL ENVELOPE SHALL BE CONSTRUCTED TO LIMIT AIR LEAKAGE IN ACCORDANCE WITH THE REQUIREMENTS OF SECTIONS R402.4.1 THROUGH R402.4.4. WHERE REQUIRED BY THE CODE OFFICIAL, TESTING SHALL BE CONDUCTED BY AN APPROVED THIRD PARTY AND A WRITTEN REPORT OF THE TESTING RESULTS SHALL BE SIGNED BY THE TESTING PARTY AND PROVIDED TO THE CODE OFFICIAL.
- AT LEAST ONE THERMOSTAT PER DWELLING UNIT SHALL BE CAPABLE OF CONTROLLING THE HEATING AND COOLING SYSTEM ON A DAILY SCHEDULE.

FLOOR AREAS:

LOT AREA:	8,750 FT ²
MAXIMUM ALLOWABLE GFA:	(40%) 3,500 FT ²
ADDITIONAL GFA FOR ADU:	(5%) 437.5 FT ²
TOTAL ALLOWABLE GFA W/ ADU:	(45%) 3,937.5 FT ²
MAIN RESIDENCE BASEMENT GFA:	[528 FT ²]
(INCLUDES STAIRS TO MAIN LEVEL; 81 FT ²)	
ELEVATOR SHAFT @ BASEMENT:	[20 FT ²]
GARAGE GFA:	[476 FT ²]
BASEMENT ADU GFA:	[586 FT ²]
BASEMENT SUBTOTAL:	[1,610 FT²]
(937.5 FT ² EXCLUDED SEE BELOW):	672 FT ²
FIRST FLOOR GFA:	1,649 FT ²
(EXCLUDE STAIR PER 19.02.020.D.2.c):	(81 FT ²)
ELEVATOR SHAFT:	20 FT ²
SECOND FLOOR GFA:	1,529 FT ²
(EXCLUDE ELEVATOR SHAFT):	(20 FT ²)
SECOND FLOOR COVERED DECK GFA:	66 FT ²
TOTAL GROSS FLOOR AREA:	(44.9%) 3,936 FT ²

BASEMENT FLOOR EXCLUSION CALCS:

WALL SEGMENT	LENGTH	COVERAGE %	RESULT
A	39'	0%	0'
B	46'	59.37%	27'-3"
C	35'	60.42%	21'-1"
D	46'	100%	46'-0"
TOTALS	162'		94'-4"

94'-4" / 162' = 58.23%

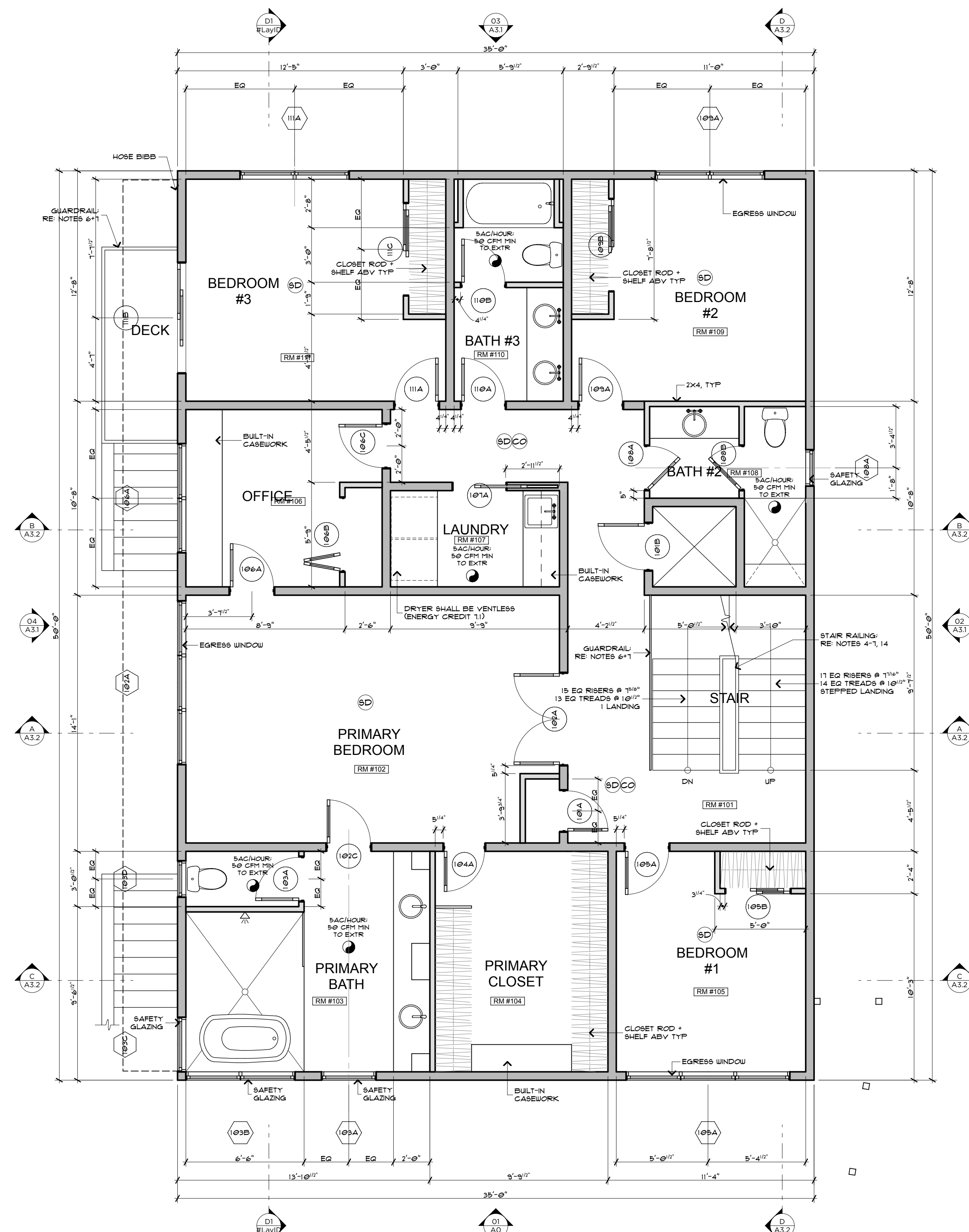

FIRST FLOOR PLAN

SCALE: 1/4" = 1'-0"



MERCER RESIDENCE
6950 SE MAKER ST MERCER ISLAND, WA
FIRST FLOOR PLAN

RELEASE
21 MARCH 2022
PERMIT CORRECTIONS
20 FEBRUARY 2023
PERMIT CORRECTIONS
2 JUNE 2023

A 2.1

MAKER AVE
MERCER ISLAND, WA 98040

PLAN NOTES:

- THIS PROJECT SHALL BE DESIGNED, ENGINEERED, + CONSTRUCTED IN FULL COMPLIANCE W/ ALL CODES + REGULATIONS.
- ALL EXTERIOR WALLS SHALL BE 2x6 UNO.
- ALL INTERIOR WALLS SHALL BE 2x4 UNO.
- ALL HANDRAILS SHALL BE LOCATED @ 36" ABOVE STAIR NOSING WITH A GRASP DIMENSION BETWEEN 1 1/8" - 2".
- ALL HANDRAILS SHALL BE CONTINUOUS OR TERMINATE AT NEWEL POST.
- ALL GUARDRAILS SHALL BE 36" ABOVE FINISHED FLOOR AND DESIGNED SUCH THAT THE MAXIMUM OPENING WILL NOT ALLOW PASSAGE OF A 4" SPHERE.
- ALL GUARDRAILS SHALL BE DESIGNED TO RESIST A 200LB CONCENTRATED LOAD AT THE TOP RAIL AND 50 PSF ON ALL GUARDRAIL INFILL COMPONENTS.
- 5/8" TYPE 'X' GWB AT ALL GARAGE WALLS AND CEILING AS WELL AS ANY POSTS + BEAMS.
- ACCESSIBLE AREA UNDER STAIR SHALL BE 1/2" GWB MINIMUM.
- PROVIDE A PROGRAMMABLE THERMOSTAT FOR THE PRIMARY SPACE CONDITIONING SYSTEM WITHIN EACH DWELLING UNIT PER SEC R403.11.
- A MINIMUM OF 75 PERCENT OF PERMANENTLY INSTALLED LAMPS IN LIGHTING FIXTURES SHALL BE HIGH-EFFICACY LAMPS.
- ALL SHOWERHEADS + KITCHEN SINK FAUCETS INSTALLED IN THE UNIT SHALL BE RATED AT 1.75 GPM OR LESS. ALL OTHER LAVATORY FAUCETS SHALL BE RATED AT 1.0 GPM OR LESS.
- ALL EXHAUST AIR SHALL VENT DIRECTLY TO THE EXTERIOR OF THE BUILDING PER M501 AND M506.2.
- ALL NEW STAIRS SHALL MEET THE FOLLOWING REQUIREMENTS:
 - MINIMUM 36" WIDTH.
 - MAXIMUM 7 3/4" RISER, MINIMUM 10" TREAD.
 - MINIMUM 6'-8" HEAD ROOM.
 - MINIMUM LANDING LENGTH 36"
- CONTRACTOR TO COMPLETE AND POST INSULATION CERTIFICATE FOR RESIDENTIAL CONSTRUCTION FORM WITHIN 3' OF ELECTRICAL PANEL PRIOR TO FINAL INSPECTION.
- WINDOW AND DOOR HEADERS SHALL BE INSULATED WITH A MINIMUM R-10 INSULATION.
- SHOULD AN AIR LEAKAGE TEST BE CONDUCTED, A WRITTEN REPORT OF THE AIR LEAKAGE TEST RESULTS SHALL BE SIGNED BY THE TESTING PARTY AND PROVIDED TO THE BUILDING INSPECTOR PRIOR TO CALL FOR FINAL INSPECTION. AIR LEAKAGE SHALL NOT EXCEED 5 AIR CHANGES/HOUR.
- WHOLE HOUSE VENTILATION INTEGRATED WITH FORCED-AIR SYSTEM PER SRC M507.5 AND SHALL RUN INTERMITTENTLY.

WSEC 2018 NOTES:

- THIS PROJECT IS ELIGIBLE AND COMPLIANT W/ WSEC 2018 PRESCRIPTIVE METHOD.
- INSULATION VALUES SHALL BE AS FOLLOWS:
 - ALL VERTICAL GLAZING SHALL BE 0.30 U-FACTOR MAX.
 - ALL OVERHEAD GLAZING SHALL BE 0.50 U-FACTOR MAX.
 - ALL EXTERIOR DOORS (INCLUDING DOORS FROM CONDITIONED SPACE TO UNCONDITIONED SPACE) SHALL BE 0.20 U-FACTOR MIN.
 - ALL CEILINGS OVER UNCONDITIONED SPACE SHALL RECEIVE R-49 BLOW-IN INSULATION MIN.
 - ALL VAULTED CEILINGS SHALL RECEIVE R-38 BATT INSULATION MIN.
 - ALL ABOVE-GRADE EXTERIOR WALLS SHALL RECEIVE R-21 BATT INSULATION MIN.
 - ALL BELOW-GRADE EXTERIOR WALLS SHALL RECEIVE R-21 BATT INSULATION MIN @ INTERIOR FRAMED WALL.
 - ALL FLOORS OVER UNCONDITIONED SPACE SHALL RECEIVE R-30 BATT INSULATION MIN.
 - ALL SLAB-ON-GRADE WITHIN CONDITIONED SPACE SHALL RECEIVE R-10 RIGID INSULATION WITHIN 24" OF SLAB PERIMETER.
 - ALL HEADERS @ EXTERIOR WALLS SHALL RECEIVE R-10 RIGID INSULATION @ INTERIOR SIDE OF WALL.
- RE: STRUCTURAL DRAWINGS FOR ALL FRAMING COMPLIANCE REQUIREMENTS.
- PROVIDE 100 CFM INTERMITTENTLY OPERATING POINT-OF-USE VENTILATION @ KITCHEN.
- PROVIDE 50 CFM INTERMITTENTLY OPERATING POINT-OF-USE VENTILATION @ ALL BATHS + LAUNDRY.
- NATURAL GAS, PROPANE OR OIL WATER HEATER SHALL HAVE A MINIMUM EF OF 0.91 (WSEC 406.2, CREDIT 5c).
- AT CRAWL SPACES THE MIN NET AREA OF VENTILATION OPENINGS SHALL NOT BE LESS THAN 1 FT² FOR EACH 300 FT² OF UNDER-FLOOR AREA. ONE VENTILATION OPENING SHALL BE WITHIN 3'-0" OF EACH CORNER OF THE BUILDING AT CRAWLSPACE. EXCEPT ONE SIDE OF THE BUILDING SHALL BE PERMITTED TO HAVE NO VENTILATION OPENINGS, OR CRAWLSPACE SHALL BE MECHANICALLY VENTED.
- THE BUILDING THERMAL ENVELOPE SHALL BE CONSTRUCTED TO LIMIT AIR LEAKAGE IN ACCORDANCE WITH THE REQUIREMENTS OF SECTIONS R402.4.1 THROUGH R402.4.4. WHERE REQUIRED BY THE CODE OFFICIAL, TESTING SHALL BE CONDUCTED BY AN APPROVED THIRD PARTY AND A WRITTEN REPORT OF THE TESTING RESULTS SHALL BE SIGNED BY THE TESTING PARTY AND PROVIDED TO THE CODE OFFICIAL.
- AT LEAST ONE THERMOSTAT PER DWELLING UNIT SHALL BE CAPABLE OF CONTROLLING THE HEATING AND COOLING SYSTEM ON A DAILY SCHEDULE.

FLOOR AREAS:

LOT AREA:	8,750 FT ²
MAXIMUM ALLOWABLE GFA:	(40%) 3,500 FT ²
ADDITIONAL GFA FOR ADU:	(5%) 437.5 FT ²
TOTAL ALLOWABLE GFA W/ ADU:	(45%) 3,937.5 FT ²

MAIN RESIDENCE BASEMENT GFA:	[528 FT ²]
(INCLUDES STAIRS TO MAIN LEVEL: 81 FT ²)	
ELEVATOR SHAFT @ BASEMENT:	[20 FT ²]
GARAGE GFA:	[476 FT ²]
BASEMENT ADU GFA:	[586 FT ²]
BASEMENT SUBTOTAL:	[1,610 FT²]
(937.5 FT ² EXCLUDED SEE BELOW):	
FIRST FLOOR GFA:	1,649 FT ²
(EXCLUDE STAIR PER 19.02.020.D.2.c):	(81 FT ²)
ELEVATOR SHAFT:	20 FT ²
SECOND FLOOR GFA:	1,529 FT ²
(EXCLUDE ELEVATOR SHAFT):	(20 FT ²)
SECOND FLOOR COVERED DECK GFA:	66 FT ²
TOTAL GROSS FLOOR AREA:	(44.9%) 3,936 FT ²

BASEMENT FLOOR EXCLUSION CALCS:

WALL SEGMENT	LENGTH	COVERAGE %	RESULT
A	39'	0%	0'
B	46'	59.57%	27'-5"
C	35'	60.42%	21'-1"
D	46'	100%	46'-0"
TOTALS	162'		94'-6"

94'-4" / 162' = 58.23%

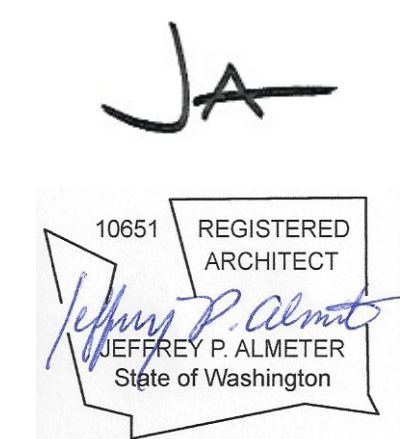
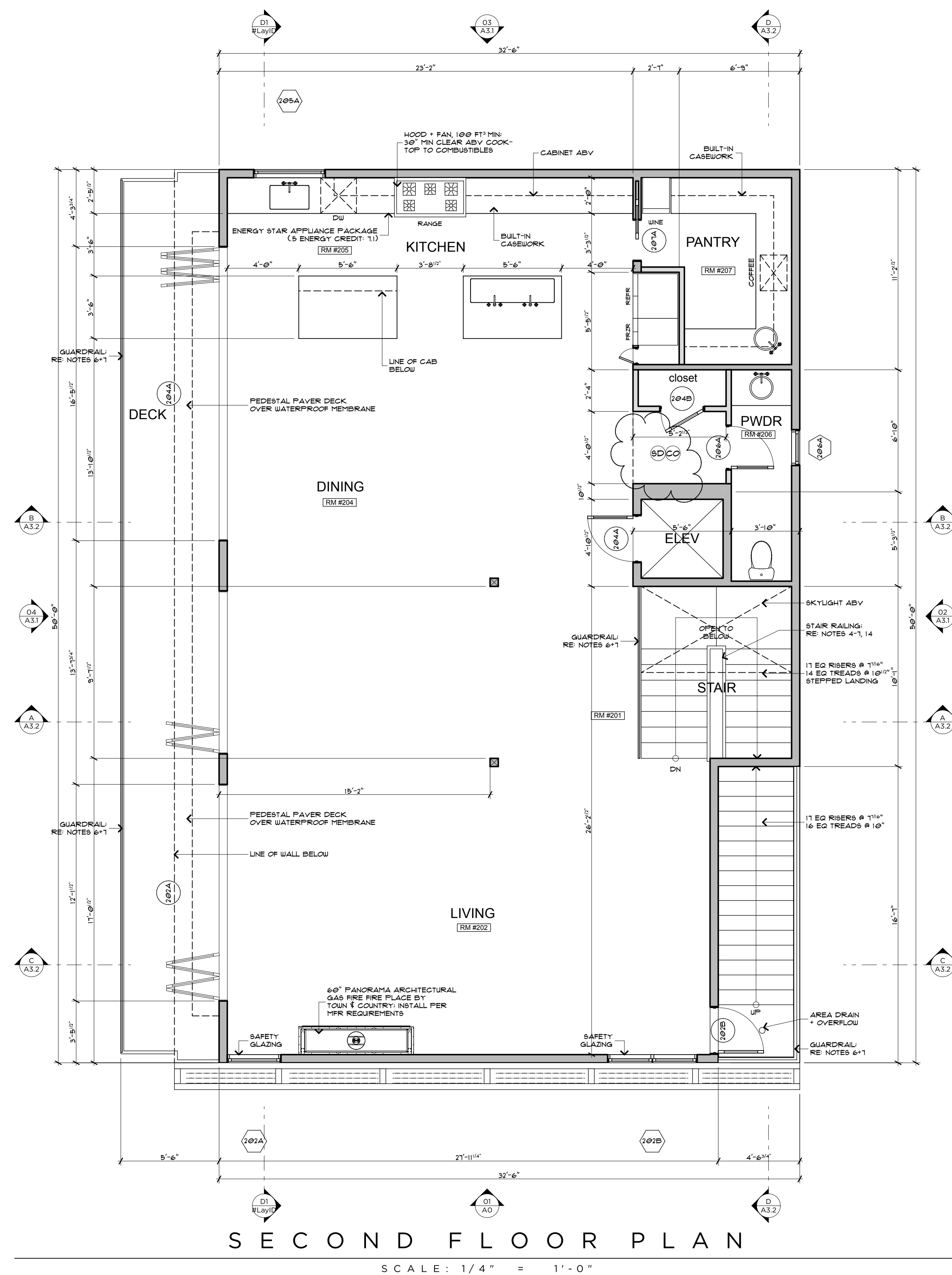

MERCER RESIDENCE
 6950 SE MAKER ST MERCER ISLAND, WA

SECOND FLOOR PLAN

RELEASE
 21 MARCH 2022
 PERMIT CORRECTIONS
 20 FEBRUARY 2023
 PERMIT CORRECTIONS
 2 JUNE 2023

A 2 . 2

MAKER AVE
 ARCHITECTS

ROOF NOTES:

1. CHIMNEY SHALL EXTEND A MIN OF 2'-0" ABV ROOF OR PARAPET WITHIN 10'-0" RADIUS OF CHIMNEY. PROVIDE APPROVED SPARK ARRESTOR @ ALL CHIMNEY CAPS. ALL ARCHITECTURAL FEATURES MUST BE PERMITTED BY FLU + SPARK ARRESTOR MFR APPROVAL.
2. COORDINATE DOWNSPOUT LOCATION W/ JEFFREY ALMETER, INC. PRIOR TO INSTALLATION.
3. ALL VENTS SHALL BE LOCATED AWAY FROM VISIBILITY @ PUBLIC RIGHT-OF-WAY.
4. TRUSS MANUFACTURERS TO PROVIDE TRUSS SHOP DRAWINGS TO JEFFREY ALMETER FOR DESIGN APPROVAL A MINIMUM OF 10 BUSINESS DAYS PRIOR TO TRUSS MANUFACTURING.

WSEC 2018 NOTES:

1. THIS PROJECT IS ELIGIBLE AND COMPLIANT W/ WSEC 2018 PRESCRIPTIVE METHOD.
2. INSULATION VALUES SHALL BE AS FOLLOWS:
 - A. ALL VERTICAL GLAZING SHALL BE 0.30 U-FACTOR MAX.
 - B. ALL OVERHEAD GLAZING SHALL BE 0.50 U-FACTOR MAX.
 - C. ALL EXTERIOR DOORS (INCLUDING DOORS FROM CONDITIONED SPACE TO UNCONDITIONED SPACE) SHALL BE 0.20 U-FACTOR MIN.
 - D. ALL CEILINGS OVER CONDITIONED SPACE SHALL RECEIVE R-49 BLOWN-IN INSULATION MIN.
 - E. ALL VAULTED CEILINGS SHALL RECEIVE R-38 BATT INSULATION MIN.
 - F. ALL ABOVE-GRADE EXTERIOR WALLS SHALL RECEIVE R-21 BATT INSULATION MIN.
 - G. ALL BELOW-GRADE EXTERIOR WALLS SHALL RECEIVE R-21 BATT INSULATION MIN @ INTERIOR FRAMED WALL.
 - H. ALL FLOORS OVER UNCONDITIONED SPACE SHALL RECEIVE R-30 BATT INSULATION MIN.
 - I. ALL SLAB-ON-GRADE WITHIN CONDITIONED SPACE SHALL RECEIVE R-10 RIGID INSULATION WITHIN 24" OF SLAB PERIMETER.
 - J. ALL HEADERS @ EXTERIOR WALLS SHALL RECEIVE R-10 RIGID INSULATION @ INTERIOR SIDE OF WALL.
3. RE: STRUCTURAL DRAWINGS FOR ALL FRAMING COMPLIANCE REQUIREMENTS.
4. PROVIDE 100 CFM INTERMITTENTLY OPERATING POINT-OF-USE VENTILATION @ KITCHEN.
5. PROVIDE 50 CFM INTERMITTENTLY OPERATING POINT-OF-USE VENTILATION @ ALL BATHS + LAUNDRY.
6. NATURAL GAS, PROPANE OR OIL WATER HEATER SHALL HAVE A MINIMUM EF OF 0.91 (WSEC 406.2, CREDIT 5a).
7. AT CRAWLSPACES THE MIN NET AREA OF VENTILATION OPENINGS SHALL NOT BE LESS THAN 1 FT² FOR EACH 300 FT² OF UNDER-FLOOR AREA. ONE VENTILATION OPENING SHALL BE WITHIN 3'-0" OF EACH CORNER OF THE BUILDING AT CRAWLSPACE. EXCEPT ONE SIDE OF THE BUILDING SHALL BE PERMITTED TO HAVE NO VENTILATION OPENINGS, OR CRAWLSPACE SHALL BE MECHANICALLY VENTED.
8. THE BUILDING THERMAL ENVELOPE SHALL BE CONSTRUCTED TO LIMIT AIR LEAKAGE IN ACCORDANCE WITH THE REQUIREMENTS OF SECTIONS R402.4.1 THROUGH R402.4.4. WHERE REQUIRED BY THE CODE OFFICIAL, TESTING SHALL BE CONDUCTED BY AN APPROVED THIRD PARTY AND A WRITTEN REPORT OF THE TESTING RESULTS SHALL BE SIGNED BY THE TESTING PARTY AND PROVIDED TO THE CODE OFFICIAL.
9. AT LEAST ONE THERMOSTAT PER DWELLING UNIT SHALL BE CAPABLE OF CONTROLLING THE HEATING AND COOLING SYSTEM ON A DAILY SCHEDULE.

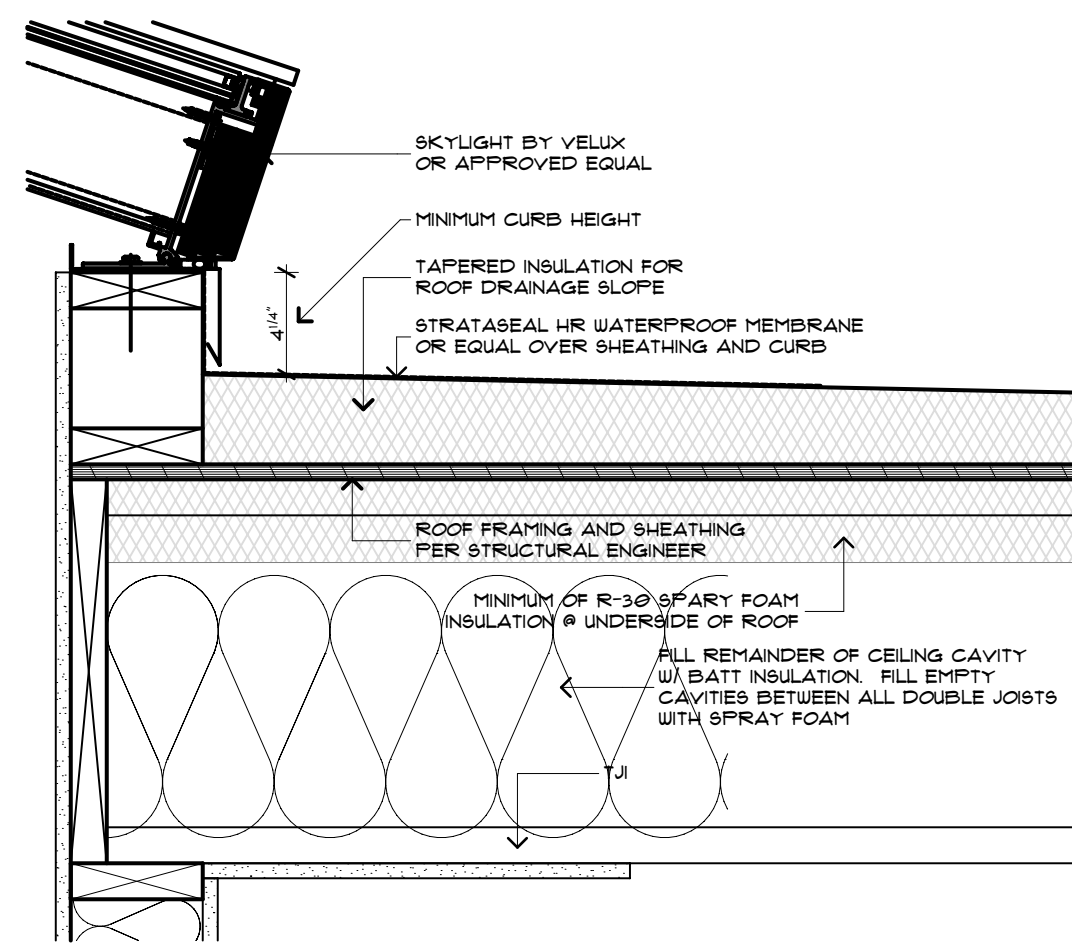

SKYLIGHT + ROOF DETAIL

SCALE: 1 1/2" = 1'-0"

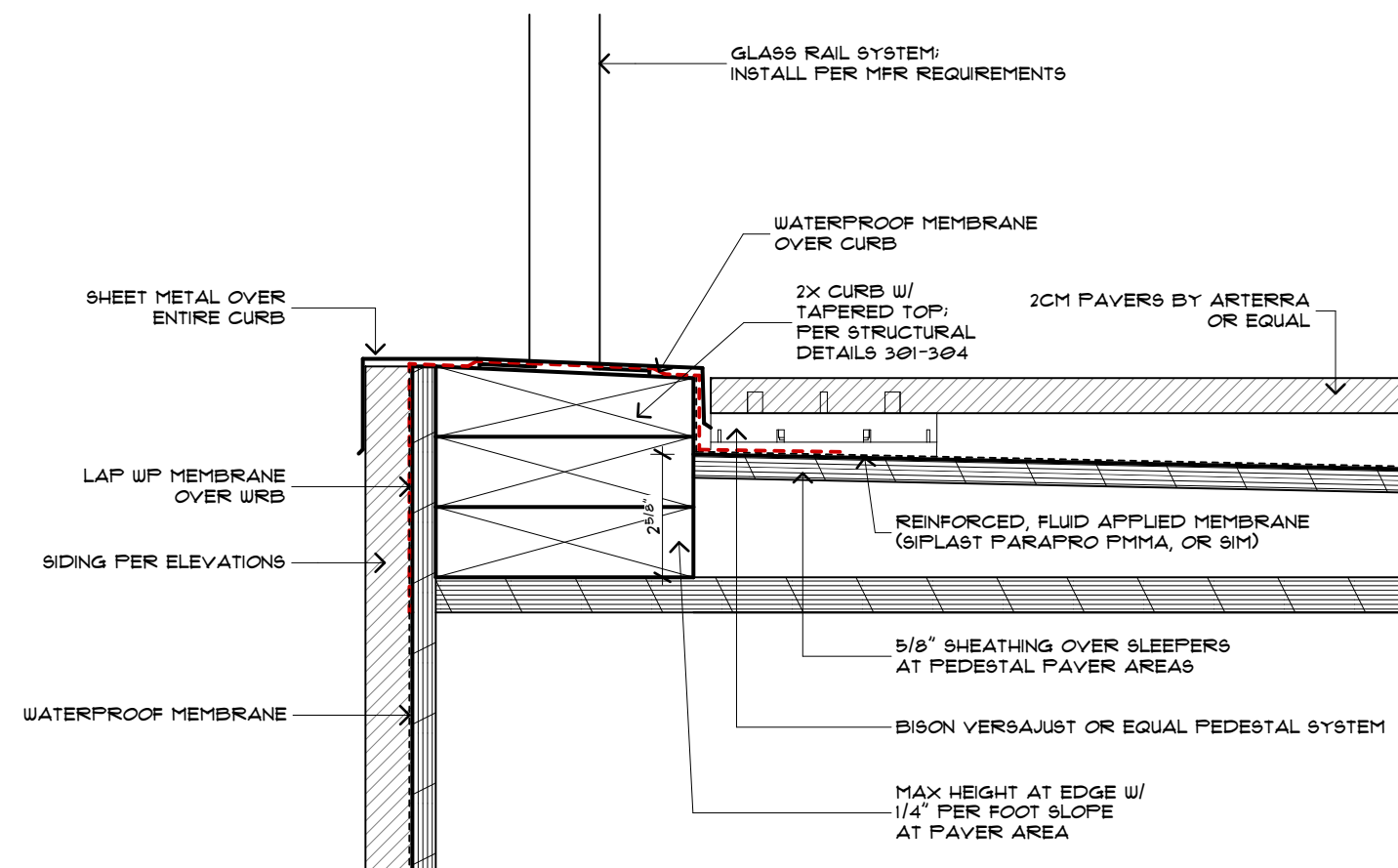

ROOF + CURB DETAIL

SCALE: 3" = 1'-0"

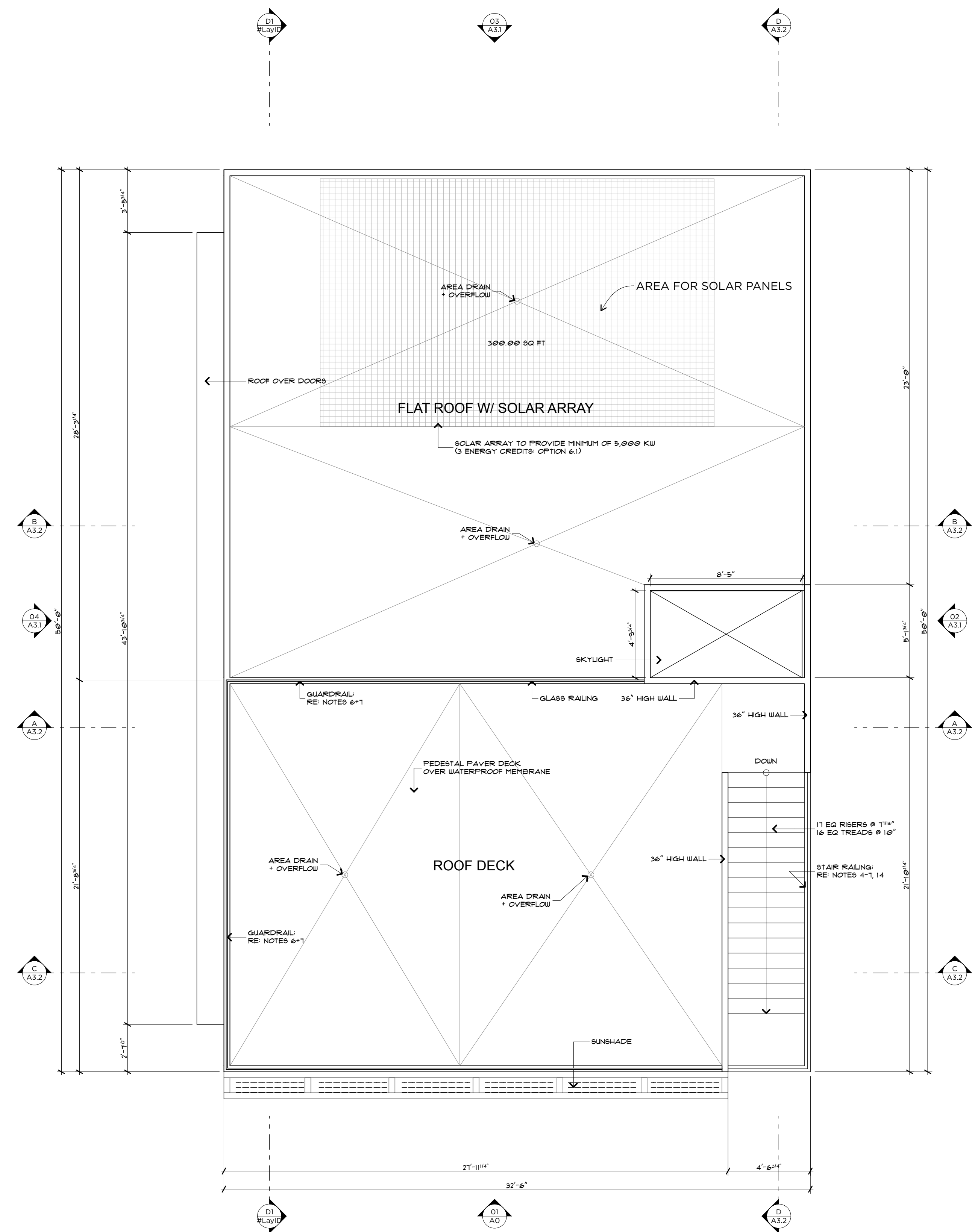

ROOF PLAN

SCALE: 1/4" = 1'-0"

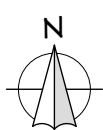

MERCER RESIDENCE
6050 SE MAKER ST MERCER ISLAND, WA

ROOF PLAN

RELEASE
21 MARCH 2022
PERMIT CORRECTIONS
20 FEBRUARY 2023
PERMIT CORRECTIONS
2 JUNE 2023

A 2 . 3

MAKER AVE
REVISED 8/20/21

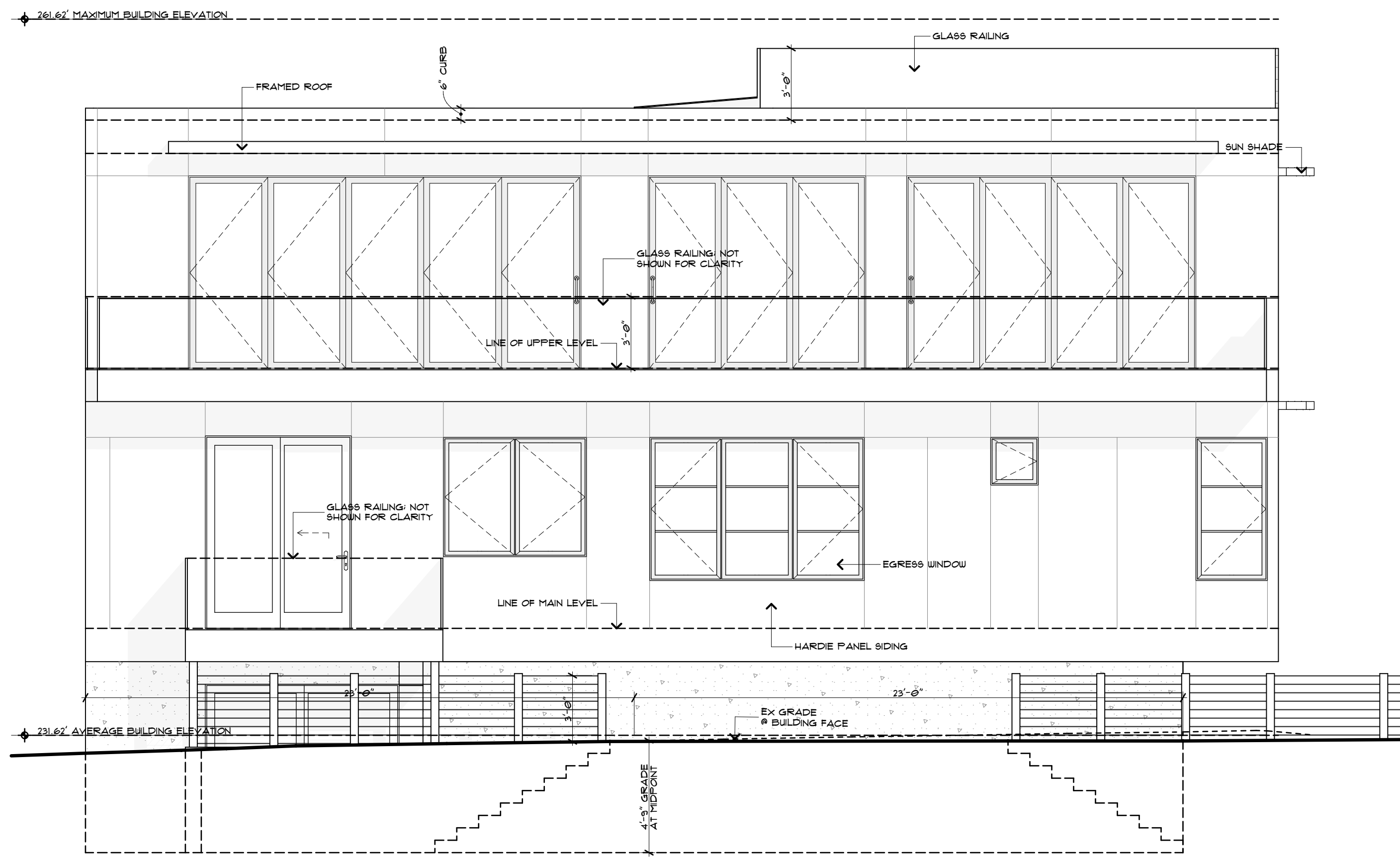

WEST ELEVATION

SCALE: 1/4" = 1'-0"

2

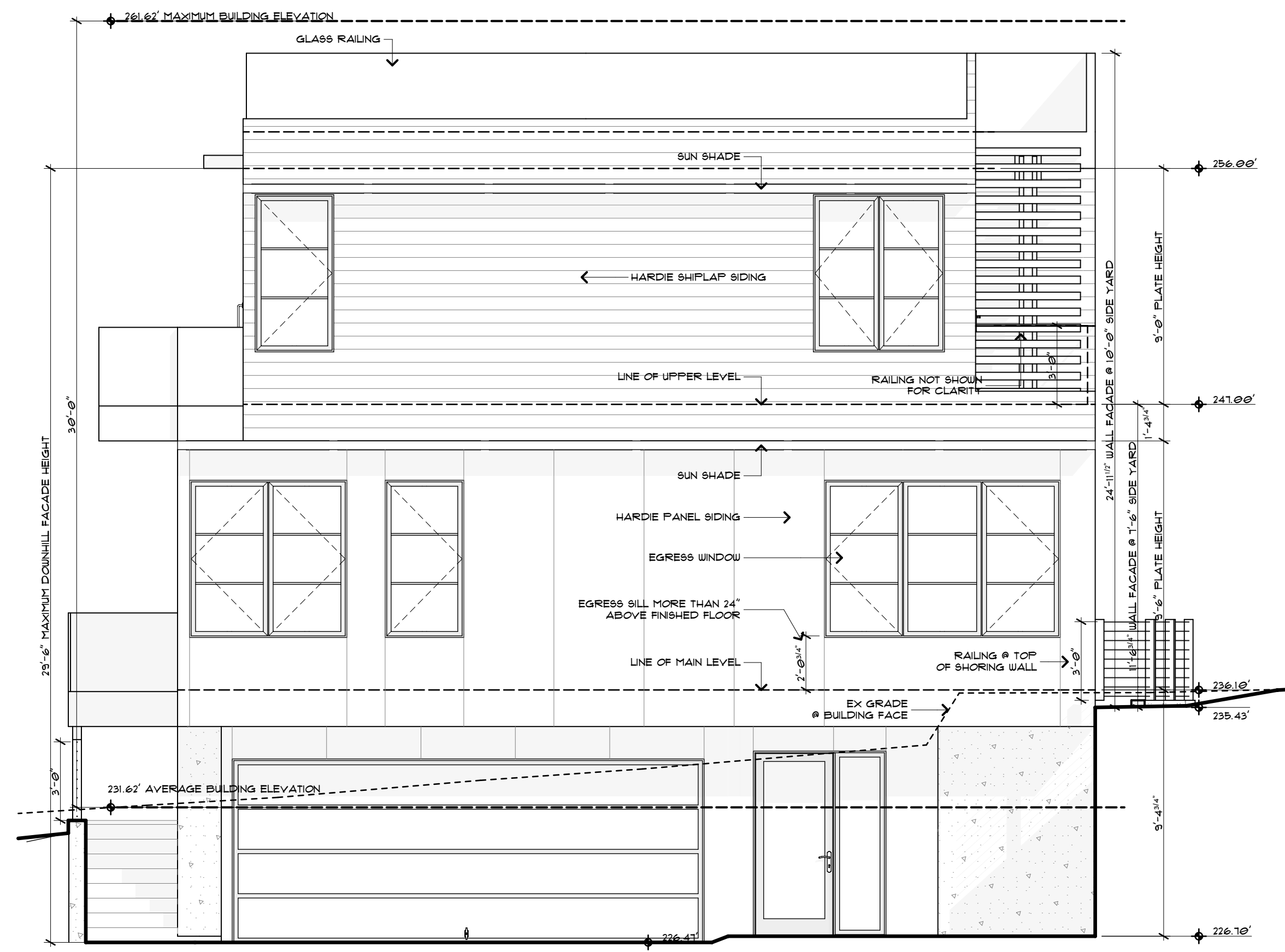

SOUTH ELEVATION

SCALE: 1/4" = 1'-0"

1

AVERAGE BUILDING ELEVATION CALCS:

SEGMENT "A" ELEVATION:	226.47'
SEGMENT "A" LENGTH:	35'
SEGMENT "A" ELEVATION x LENGTH:	7,926.45 FT ²
SEGMENT "B" ELEVATION:	231.25'
SEGMENT "B" LENGTH:	46'
SEGMENT "B" ELEVATION x LENGTH:	10,637.5 FT ²
SEGMENT "C" ELEVATION:	231.50'
SEGMENT "C" LENGTH:	35'
SEGMENT "C" ELEVATION x LENGTH:	8,102.50 FT ²
SEGMENT "D" ELEVATION:	236.00'
SEGMENT "D" LENGTH:	46'
SEGMENT "D" ELEVATION x LENGTH:	10,856.00 FT ²
TOTAL OF AGGREGATE ELEVATION:	37,522.45'
TOTAL OF SEGMENT LENGTHS:	162'
AVERAGE BUILDING ELEVATION:	231.62'

REVIEW AND APPROVAL OF THE DEFERRED SUBMITTAL FOR THE GLASS GUARD SYSTEM AND ATTACHMENTS IS REQUIRED BY THE CITY PRIOR TO FABRICATION OF THE COMPONENTS.

NOTE: ALL EXTERIOR WATERPROOFING OF WALLS INCLUDING DOOR + WINDOW OPENINGS SHALL BE BY GENERAL CONTRACTOR

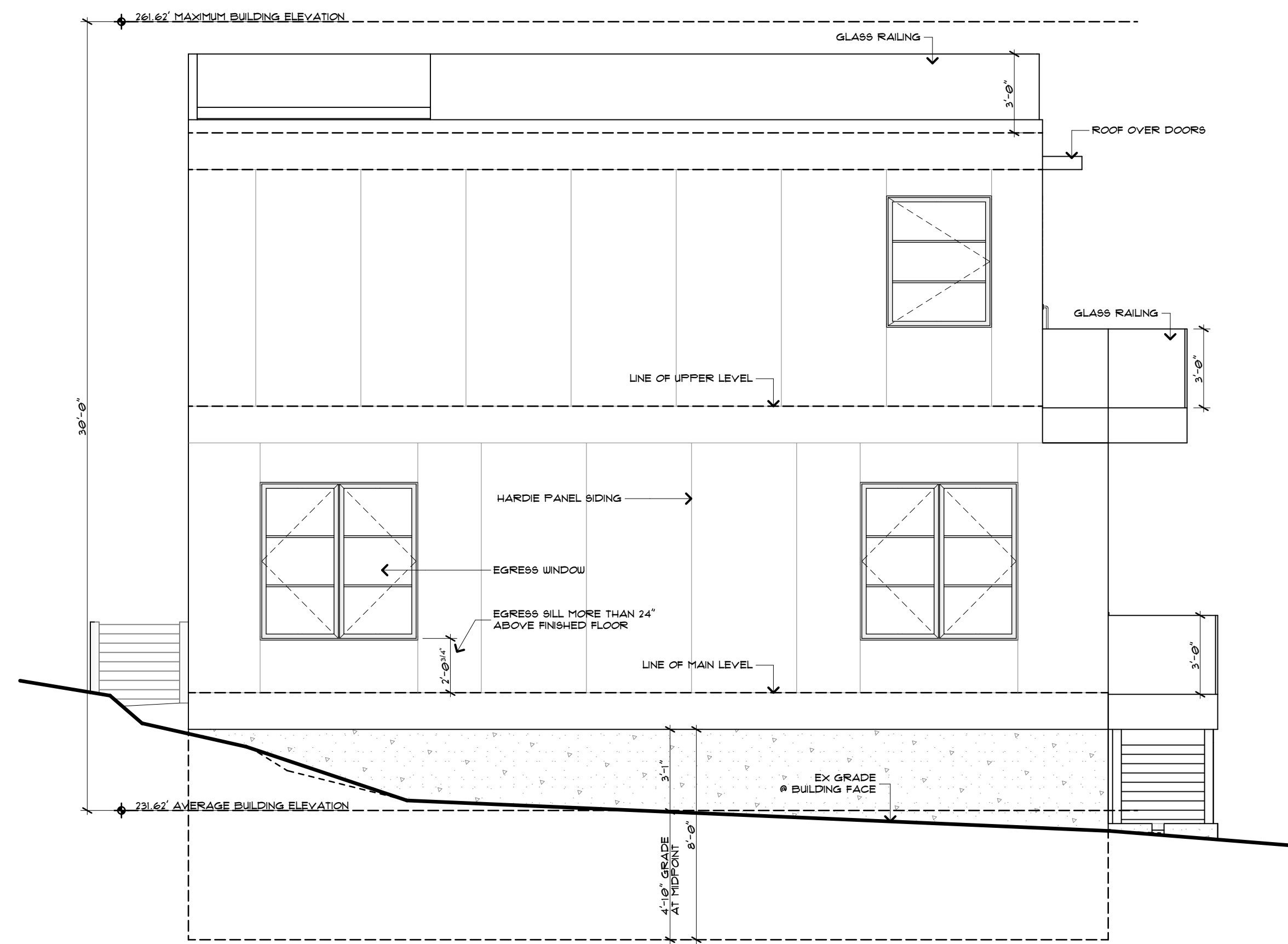

NORTH ELEVATION

SCALE: 1/4" = 1'-0"

4

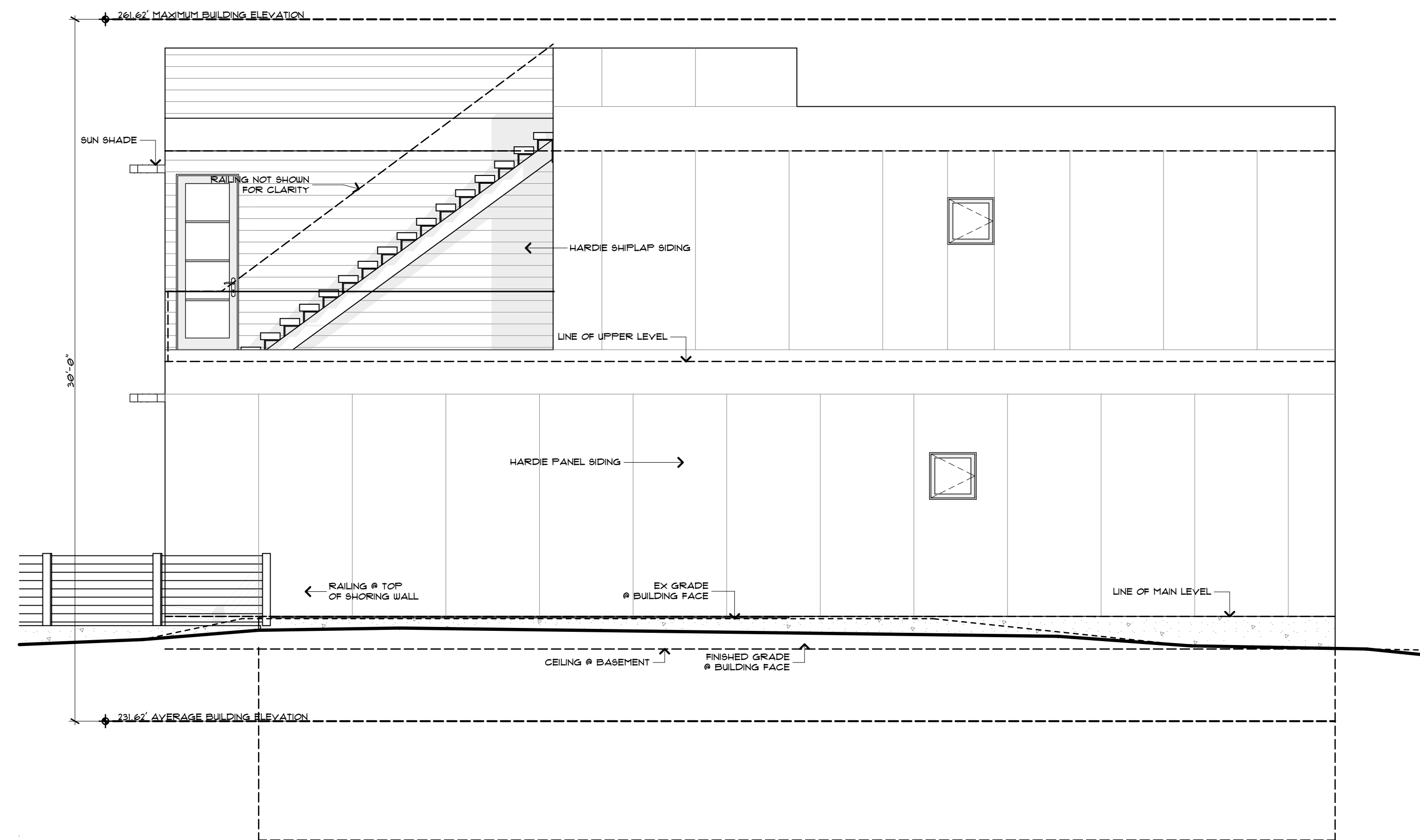

EAST ELEVATION

SCALE: 1/4" = 1'-0"

3



MERCER RESIDENCE
6950 SE MAKER ST MERCER ISLAND, WA

BUILDING ELEVATIONS

RELEASE
21 MARCH 2022
PERMIT CORRECTIONS
20 FEBRUARY 2023
PERMIT CORRECTIONS
2 JUNE 2023

A 3.1

MAKER AVE
REVISED 2/2023

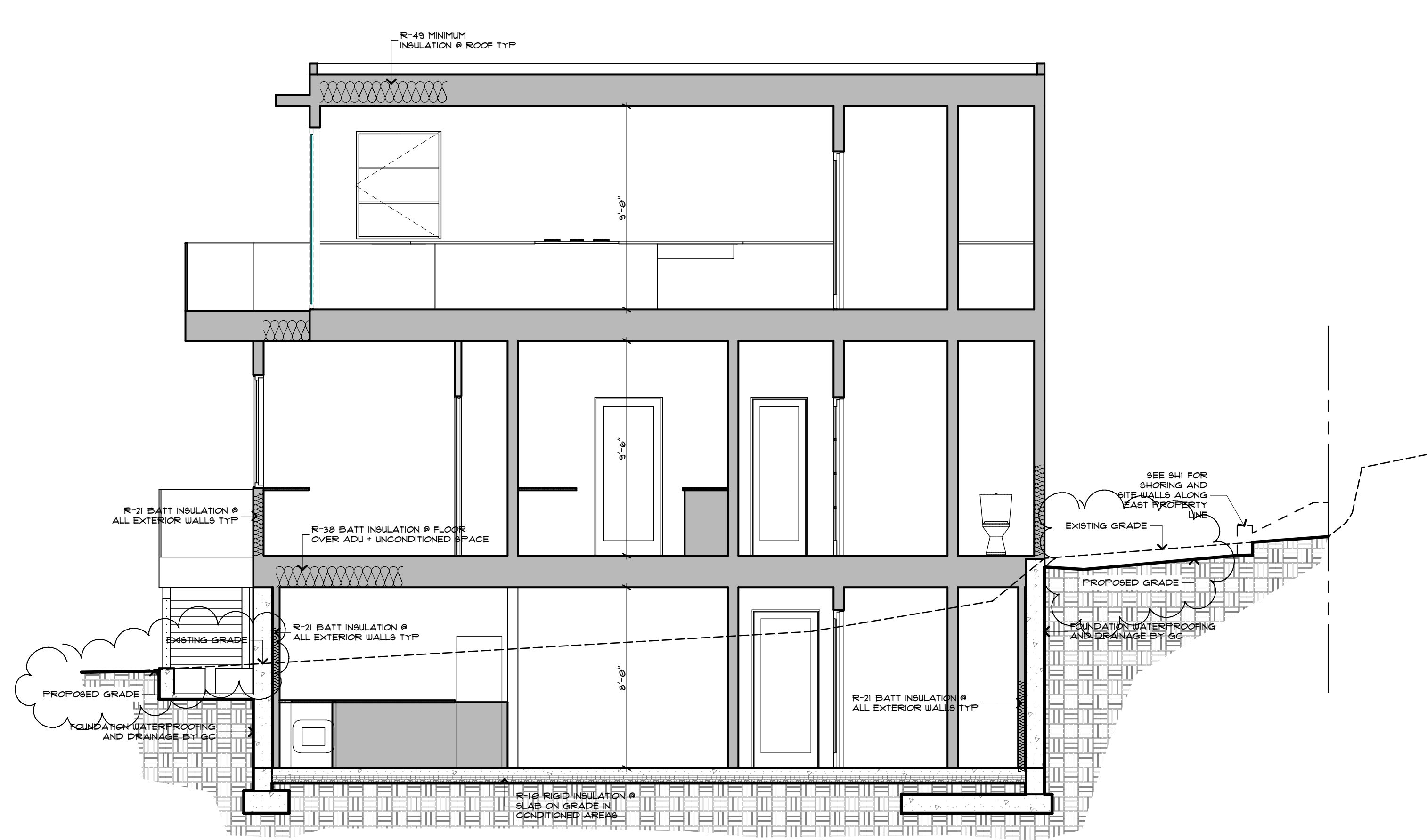

SECTION B - B

SCALE: 1/4" = 1'-0"

B

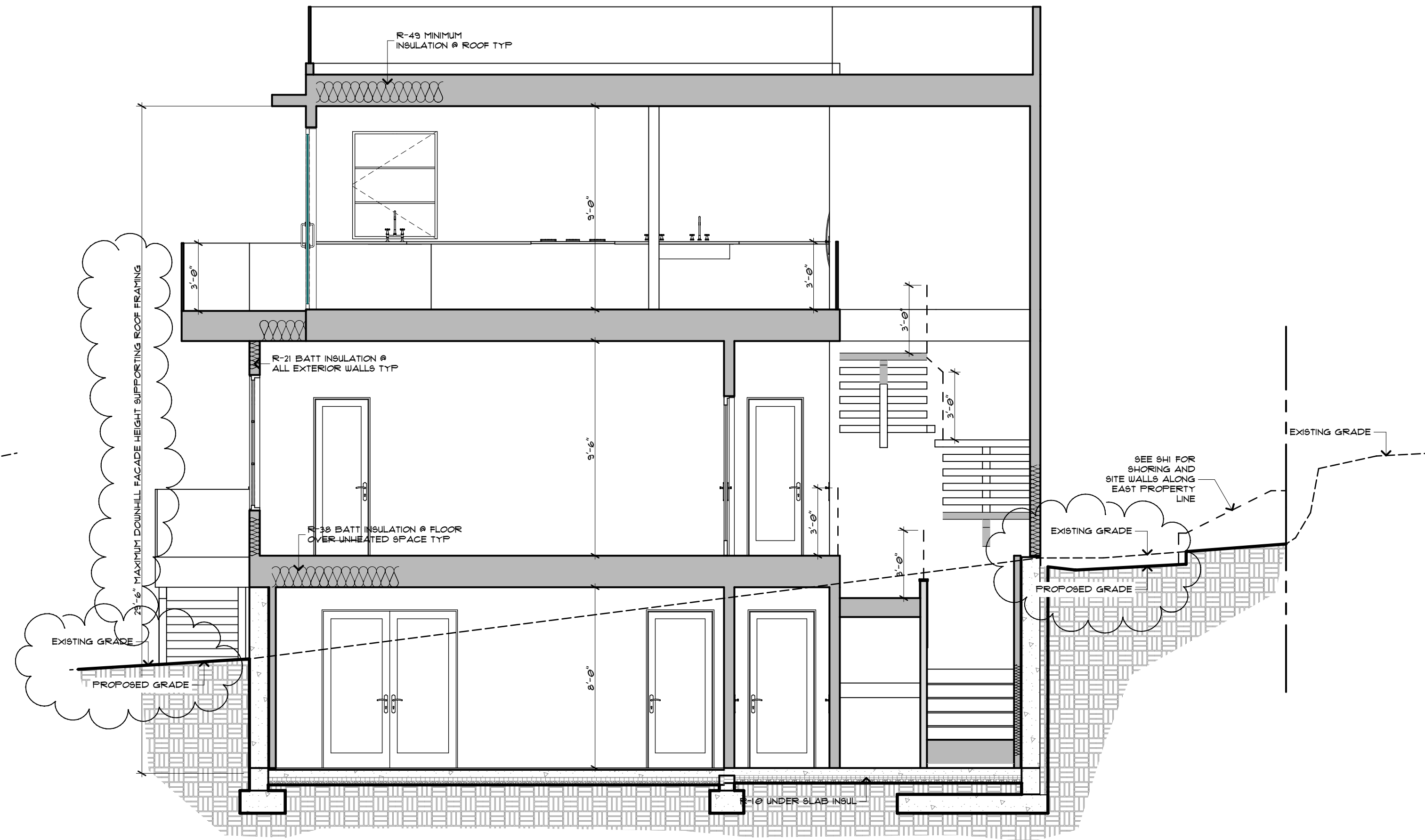

SECTION A - A

SCALE: 1/4" = 1'-0"

A

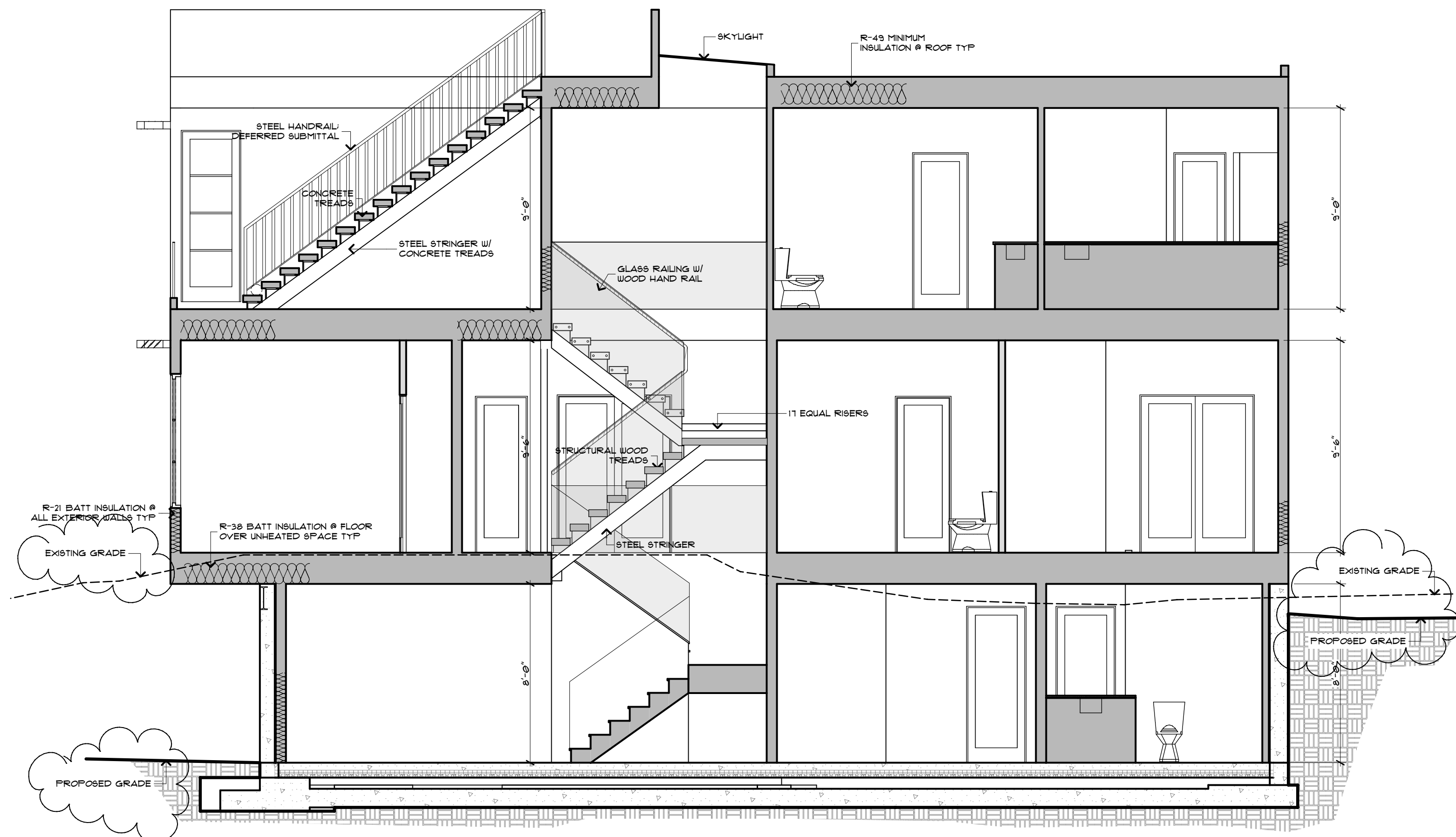

SECTION D - D

SCALE: 1/4" = 1'-0"

D

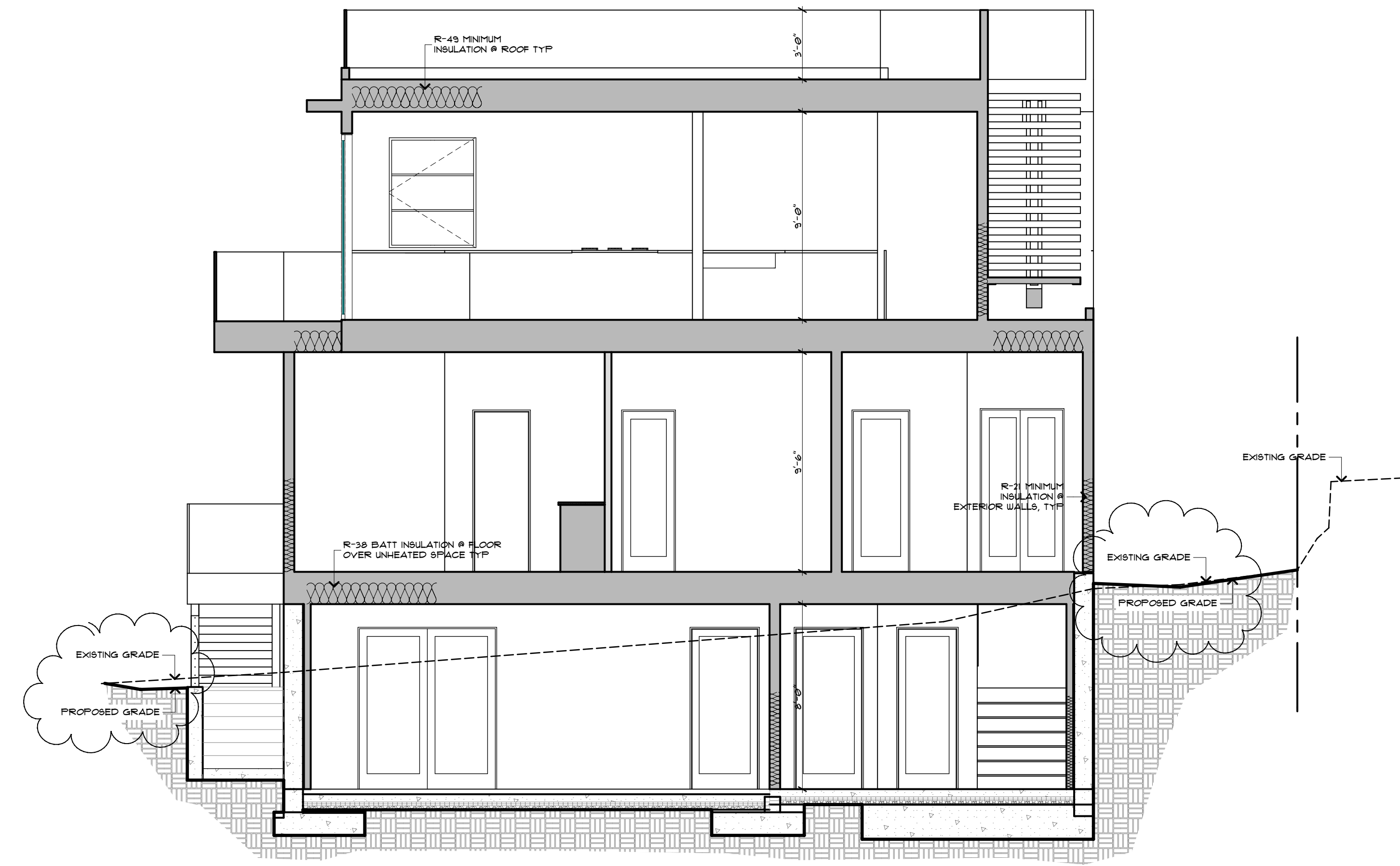

SECTION C - C

SCALE: 1/4" = 1'-0"

C

REVIEW AND APPROVAL OF THE DEFERRED SUBMITTAL FOR THE GLASS GUARD SYSTEM AND ATTACHMENTS IS REQUIRED BY THE CITY PRIOR TO FABRICATION OF THE COMPONENTS.

WSEC 2018 NOTES:

- THIS PROJECT IS ELIGIBLE AND COMPLIANT W/ WSEC 2018 PRESCRIPTIVE METHOD.
- INSULATION VALUES SHALL BE AS FOLLOWS:
 - ALL VERTICAL GLAZING SHALL BE 0.30 U-FACTOR MAX.
 - ALL OVERHEAD GLAZING SHALL BE 0.50 U-FACTOR MAX.
 - ALL EXTERIOR DOORS (INCLUDING DOORS FROM CONDITIONED SPACE TO UNCONDITIONED SPACE) SHALL BE 0.20 U-FACTOR MIN.
 - ALL CEILINGS OVER CONDITIONED SPACE SHALL RECEIVE R-49 BLOWN-IN INSULATION MIN.
 - ALL VAULTED CEILINGS SHALL RECEIVE R-38 BATT INSULATION MIN.
 - ALL ABOVE-GRADE EXTERIOR WALLS SHALL RECEIVE R-21 BATT INSULATION MIN.
 - ALL BELOW-GRADE EXTERIOR WALLS SHALL RECEIVE R-21 BATT INSULATION MIN @ INTERIOR FRAMED WALL.
 - ALL FLOORS OVER UNCONDITIONED SPACE SHALL RECEIVE R-30 BATT INSULATION MIN.
 - ALL SCAB-ON-GRADE WITHIN CONDITIONED SPACE SHALL RECEIVE R-10 RIGID INSULATION WITHIN 24" OF SLAB PERIMETER.
 - ALL HEADERS @ EXTERIOR WALLS SHALL RECEIVE R-10 RIGID INSULATION @ INTERIOR SIDE OF WALL.
- RE: STRUCTURAL DRAWINGS FOR ALL FRAMING COMPLIANCE REQUIREMENTS.
- PROVIDE 100 CFM INTERMITTENTLY OPERATING POINT-OF-USE VENTILATION @ KITCHEN.
- PROVIDE 50 CFM INTERMITTENTLY OPERATING POINT-OF-USE VENTILATION @ ALL BATHS + LAUNDRY.
- NATURAL GAS, PROPANE OR OIL WATER HEATER SHALL HAVE A MINIMUM EF OF 0.91 (WSEC 406.2, CREDIT 5c).
- AT CRAWLSPACES THE MIN NET AREA OF VENTILATION OPENINGS SHALL NOT BE LESS THAN 1 FT² FOR EACH 300 FT² OF UNDER-FLOOR AREA. ONE VENTILATION OPENING SHALL BE WITHIN 3'-0" OF EACH CORNER OF THE BUILDING AT CRAWLSPACE, EXCEPT ONE SIDE OF THE BUILDING SHALL BE PERMITTED TO HAVE NO VENTILATION OPENINGS, OR CRAWLSPACE SHALL BE MECHANICALLY VENTED.
- THE BUILDING THERMAL ENVELOPE SHALL BE CONSTRUCTED TO LIMIT AIR LEAKAGE IN ACCORDANCE WITH THE REQUIREMENTS OF SECTIONS R402.41 THROUGH R402.4.4. WHERE REQUIRED BY THE CODE OFFICIAL, TESTING SHALL BE CONDUCTED BY AN APPROVED THIRD PARTY AND A WRITTEN REPORT OF THE TESTING RESULTS SHALL BE SIGNED BY THE TESTING PARTY AND PROVIDED TO THE CODE OFFICIAL.
- AT LEAST ONE THERMOSTAT PER DWELLING UNIT SHALL BE CAPABLE OF CONTROLLING THE HEATING AND COOLING SYSTEM ON A DAILY SCHEDULE.

DOOR SCHEDULE: (ALL GLAZING TO BE NFRC CERTIFIED)

DOOR NO.	WIDTH	HEIGHT	TYPE	MATERIAL	FINISH	HARDWARE	NOTES / REMARKS
001A	3'-0"	7'-0"	ENTRY	CLAD WOOD	PAINTED	TBD	WITH 2'-0" SIDELIGHT
001B	2'-8"	7'-0"	SWING	WOOD	PAINTED	TBD	
001C	3'-0"	7'-0"	SWING	WOOD	PAINTED	TBD	20-MIN RATED, AUTO-CLOSE
001D	2'-8"	7'-0"	SWING	WOOD	PAINTED	TBD	LOCKING, ELEVATOR
002A	18'-0"	7'-0"	OVERHEAD	WOOD	PAINTED	TBD	
002B	6'-0"	7'-0"	SWING	WOOD	PAINTED	TBD	
003A	3'-0"	7'-0"	SWING	WOOD	PAINTED	TBD	20 MIN RATED, AUTO-CLOSE
004A	2'-8"	7'-0"	SWING	WOOD	PAINTED	TBD	LOCKING, 1-HR RATED
005A	3'-0"	7'-0"	SWING	WOOD	PAINTED	TBD	LOCKING, 1-HR RATED
005B	4'-0"	7'-0"	SWING	WOOD	PAINTED	TBD	
005C	9'-0"	7'-0"	BI-FOLD	CLAD WOOD	PAINTED	TBD	3-PANEL
005C	9'-0"	8'-0"	BI-FOLD	CLAD WOOD	PAINTED	TBD	3-PANEL, SAFETY GLAZING
006A	2'-8"	7'-0"	SWING	WOOD	PAINTED	TBD	
101A	2'-4"	7'-0"	SWING	WOOD	PAINTED	TBD	
101B	2'-8"	7'-0"	SWING	WOOD	PAINTED	TBD	ELEVATOR, LOCKING
102A	5'-0"	7'-0"	SWING	WOOD	PAINTED	TBD	PAIR
102B	8'-0"	7'-0"	SLIDER	CLAD WOOD	PAINTED	TBD	LOCKING, SAFETY GLAZING
102C	2'-8"	7'-0"	SWING	WOOD	PAINTED	TBD	
103A	2'-8"	7'-0"	SWING	WOOD	PAINTED	TBD	
104A	2'-4"	7'-0"	SWING	WOOD	PAINTED	TBD	
105A	2'-6"	7'-0"	SWING	WOOD	PAINTED	TBD	
105B	3'-6"	7'-0"	BYPASS	WOOD	PAINTED	TBD	CLOSET
106A	2'-6"	7'-0"	SWING	WOOD	PAINTED	TBD	
106B	4'-0"	7'-0"	BI-FOLD	WOOD	PAINTED	TBD	
106C	2'-6"	7'-0"	SWING	WOOD	PAINTED	TBD	
107A	3'-0"	7'-0"	POCKET	WOOD	PAINTED	TBD	
108A	2'-6"	7'-0"	SWING	WOOD	PAINTED	TBD	
108B	2'-6"	7'-0"	SWING	WOOD	PAINTED	TBD	
109A	2'-6"	7'-0"	SWING	WOOD	PAINTED	TBD	
109B	5'-0"	7'-0"	BYPASS	WOOD	PAINTED	TBD	CLOSET
110A	2'-6"	7'-0"	SWING	WOOD	PAINTED	TBD	
110B	2'-6"	7'-0"	SWING	WOOD	PAINTED	TBD	
111A	2'-6"	7'-0"	SWING	WOOD	PAINTED	TBD	
111B	6'-0"	8'-0"	SLIDER	CLAD WOOD	PAINTED	TBD	2-PANEL, WITH SCREEN
111C	5'-0"	7'-0"	BYPASS	WOOD	PAINTED	TBD	CLOSET
202A	12'-0"	8'-0"	BI-FOLD	CLAD WOOD	PAINTED	TBD	4-PANEL, SAFETY GLAZING
202B	2'-8"	7'-8"	SWING	WOOD/GLASS	PAINTED	TBD	SAFETY GLAZING
204A	2'-8"	7'-0"	SWING	WOOD	PAINTED	TBD	ELEVATOR, LOCKING
204A	16'-4"	8'-0"	BI-FOLD	CLAD WOOD	PAINTED	TBD	6-PANEL, SAFETY GLAZING
204B	11'-0"	7'-0"	SWING	WOOD	PAINTED	TBD	
204B	2'-6"	7'-0"	SWING	WOOD	PAINTED	TBD	
206A	2'-6"	7'-0"	SWING	WOOD	PAINTED	TBD	
207A	2'-4"	7'-0"	POCKET	WOOD	PAINTED	TBD	

WINDOW SCHEDULE: (ALL GLAZING TO BE NFRC CERTIFIED)

WINDOW NO.	WIDTH	HEIGHT	HEADER	TYPE	MATERIAL	FINISH	NOTES / REMARKS
102A	9'-0"	6'-0"	6'-0"	CASEMENT	CLAD WOOD	PAINTED	TRIPLE, EGRESS
103A	3'-0"	6'-0"	6'-0"	CASEMENT	CLAD WOOD	PAINTED	
103B	6'-0"	6'-0"	6'-0"	CASEMENT	CLAD WOOD	PAINTED	PAIR
103C	3'-0"	6'-0"	6'-0"	CASEMENT	CLAD WOOD	PAINTED	
103D	2'-0"	2'-0"	6'-0"	CASEMENT	CLAD WOOD	PAINTED	
105A	9'-0"	6'-0"	6'-0"	CASEMENT	CLAD WOOD	PAINTED	TRIPLE, EGRESS
106A	6'-0"	5'-0"	6'-0"	CASEMENT	CLAD WOOD	PAINTED	PAIR
108A	2'-0"	2'-0"	7'-0"	CASEMENT	CLAD WOOD	PAINTED	
109A	6'-0"	6'-0"	6'-0"	CASEMENT	CLAD WOOD	PAINTED	PAIR, EGRESS
111A	6'-0"	6'-0"	6'-0"	CASEMENT	CLAD WOOD	PAINTED	PAIR
202A	3'-0"	6'-0"	6'-0"	CASEMENT	CLAD WOOD	PAINTED	
202B	5'-0"	6'-0"	6'-0"	CASEMENT	CLAD WOOD	PAINTED	PAIR
205A	4'-0"	5'-0"	6'-0"	FIXED	CLAD WOOD	PAINTED	
206A	2'-0"	2'-0"	7'-0"	CASEMENT	CLAD WOOD	PAINTED	

NANAWALL SYSTEM CPD INFO

CPD #	U-factor	SHGC	VT	Condensation Resistance	Air Leakage	Ventilation Rating (Standard Screen)	Ventilation Rating (Enhanced Screen)			
NAN-M-1-03122-00001	0.30	0.21	0.39	59						
Group ID	Manufacturer Product Code	Frame/Sash Type	Glazing Layers	Low-E	Gap Widths	Spacer	Gap Fill	Grid	Divider	Tint
1	*Outswing-Floor Mounted-Flush Sill: SKN 165 / Arg / Clear - 1" (1/4"-5/32")	WAWA	2	0.019(2)	0.625	TP-D	Fill 1: ARG/AIR(90/10)	N	-	CL

PELLA SLIDING DOOR CPD INFO

CPD #	U-factor	SHGC	VT	Condensation Resistance	Air Leakage	Ventilation Rating (Standard Screen)	Ventilation Rating (Enhanced Screen)			
PEL-N-237-00945-00001	0.28	0.17	0.39	57						
Group ID	Manufacturer Product Code	Frame/Sash Type	Glazing Layers	Low-E	Gap Widths	Spacer	Gap Fill	Grid	Divider	Tint
1	*Pine - 3mm 366 Arg 3mm - 13/16"	WAWA	2	0.02(2)	0.58	SS-D	Fill 1: ARG/AIR(90/10)	N	-	CL



MERCER RESIDENCE
6050 SE MAKER ST
MERCER ISLAND, WA

DOOR + WINDOW SCHEDULES

RELEASE
21 MARCH 2022
PERMIT CORRECTIONS
20 FEBRUARY 2023
PERMIT CORRECTIONS
2 JUNE 2023

A 4 . 1

MAKER AVE
REVISED 8/20/21

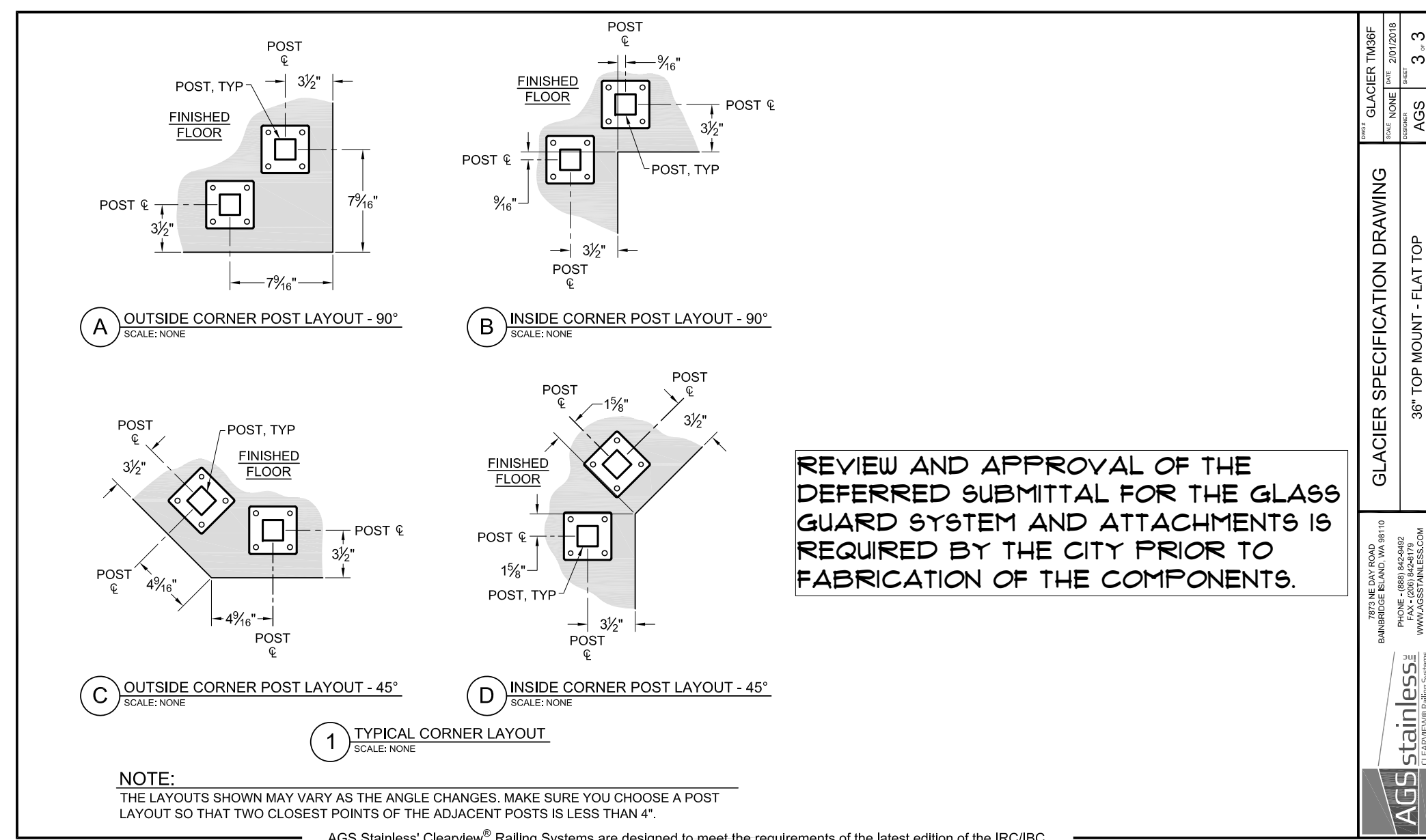
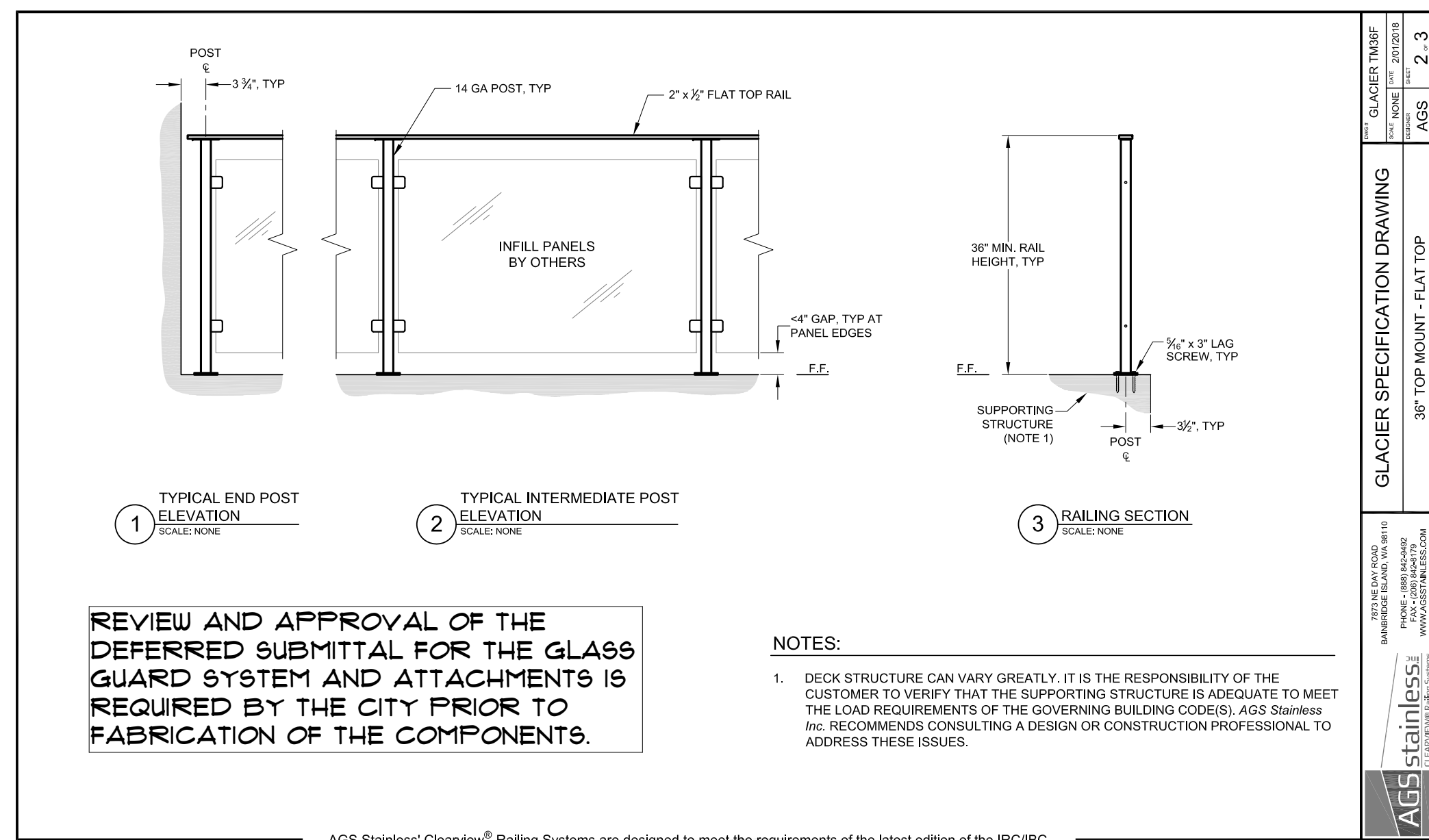
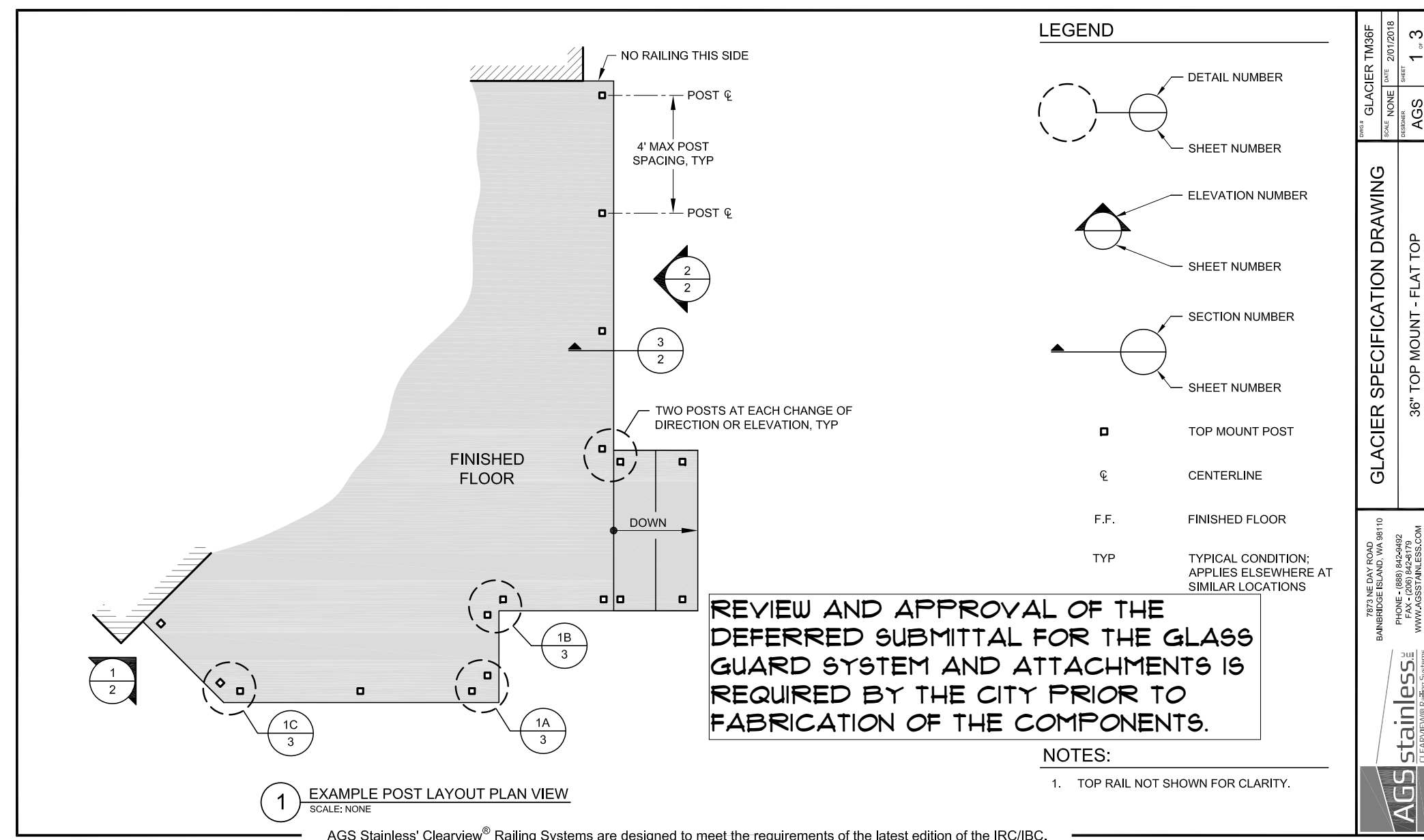

GLASS RAILING DETAIL

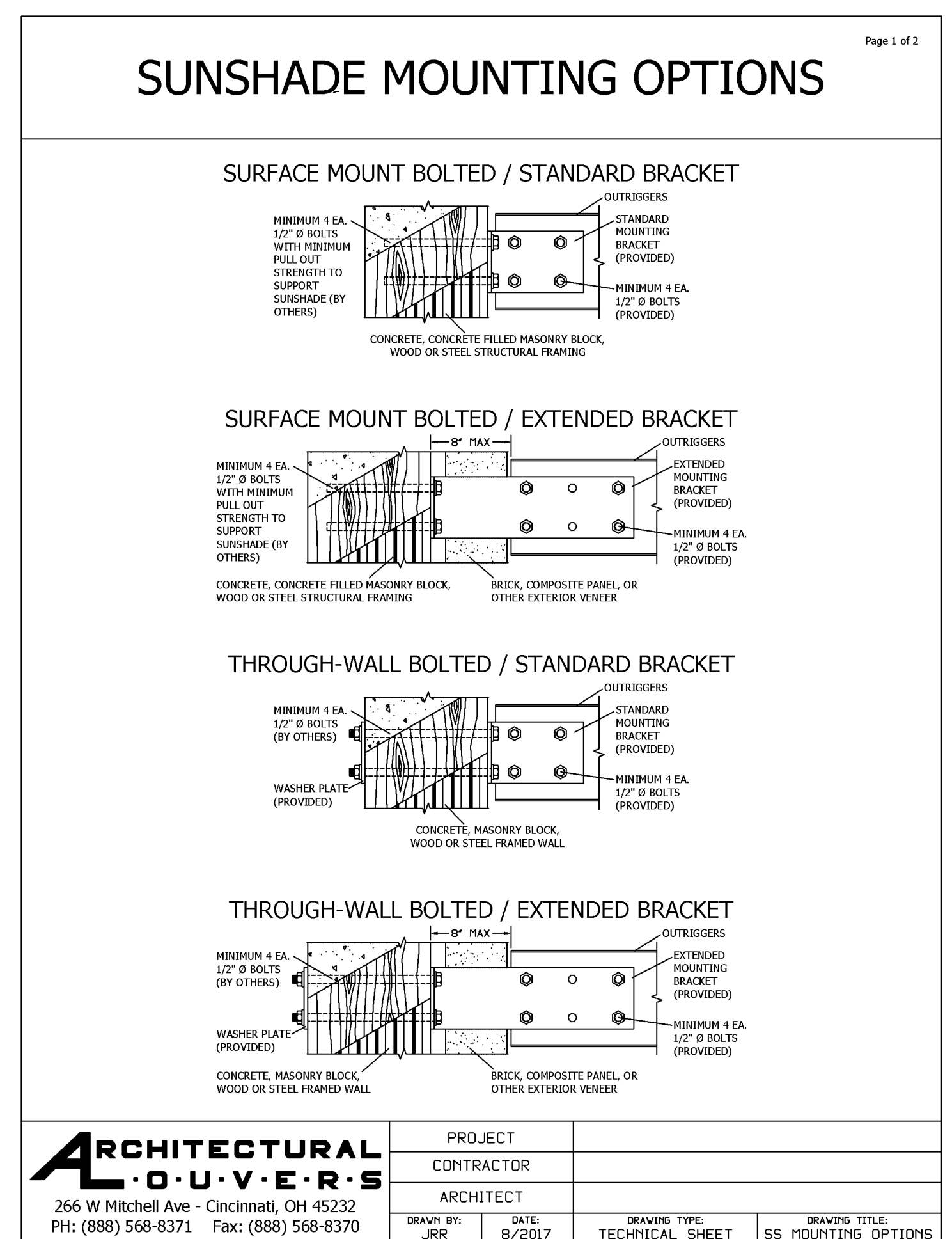
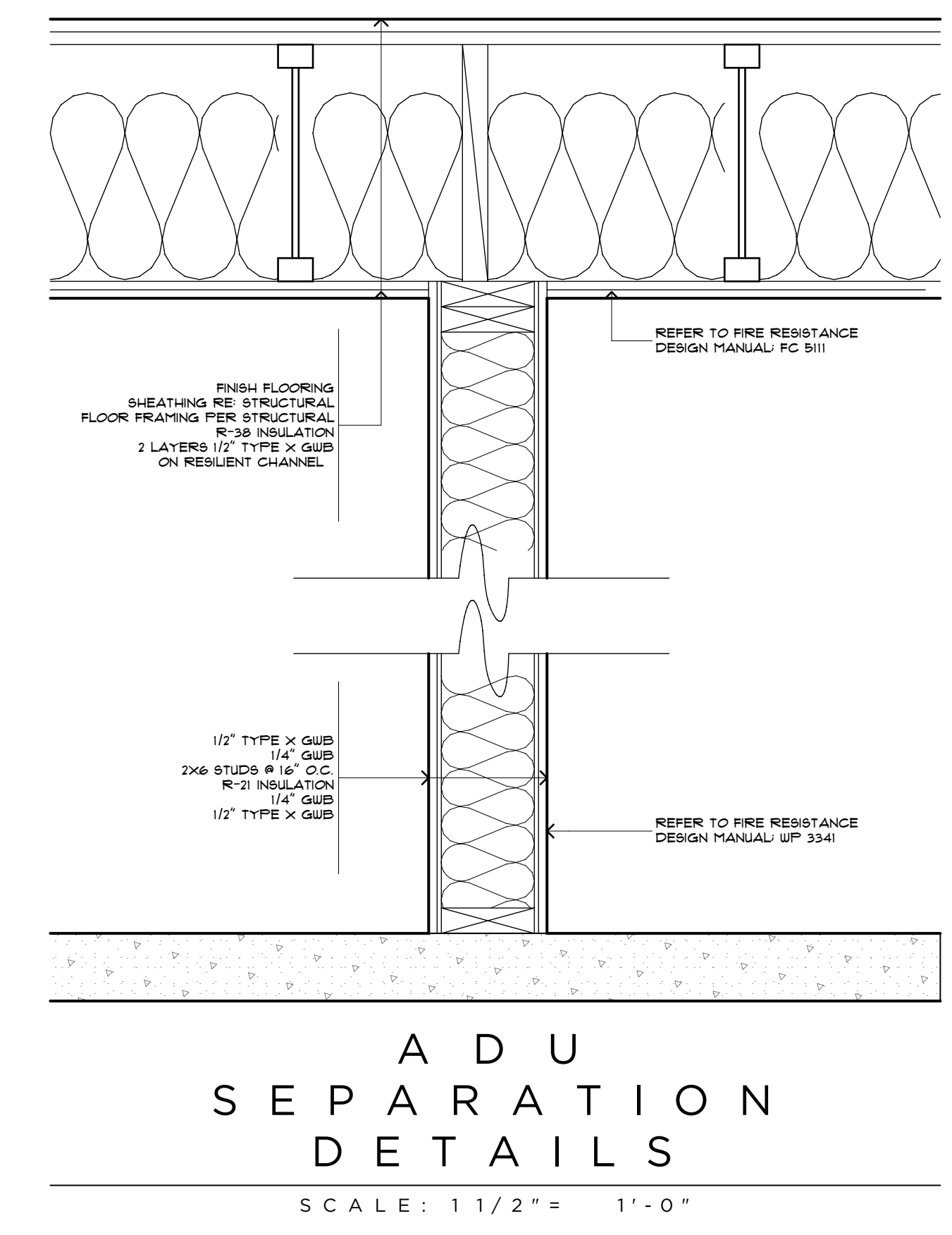
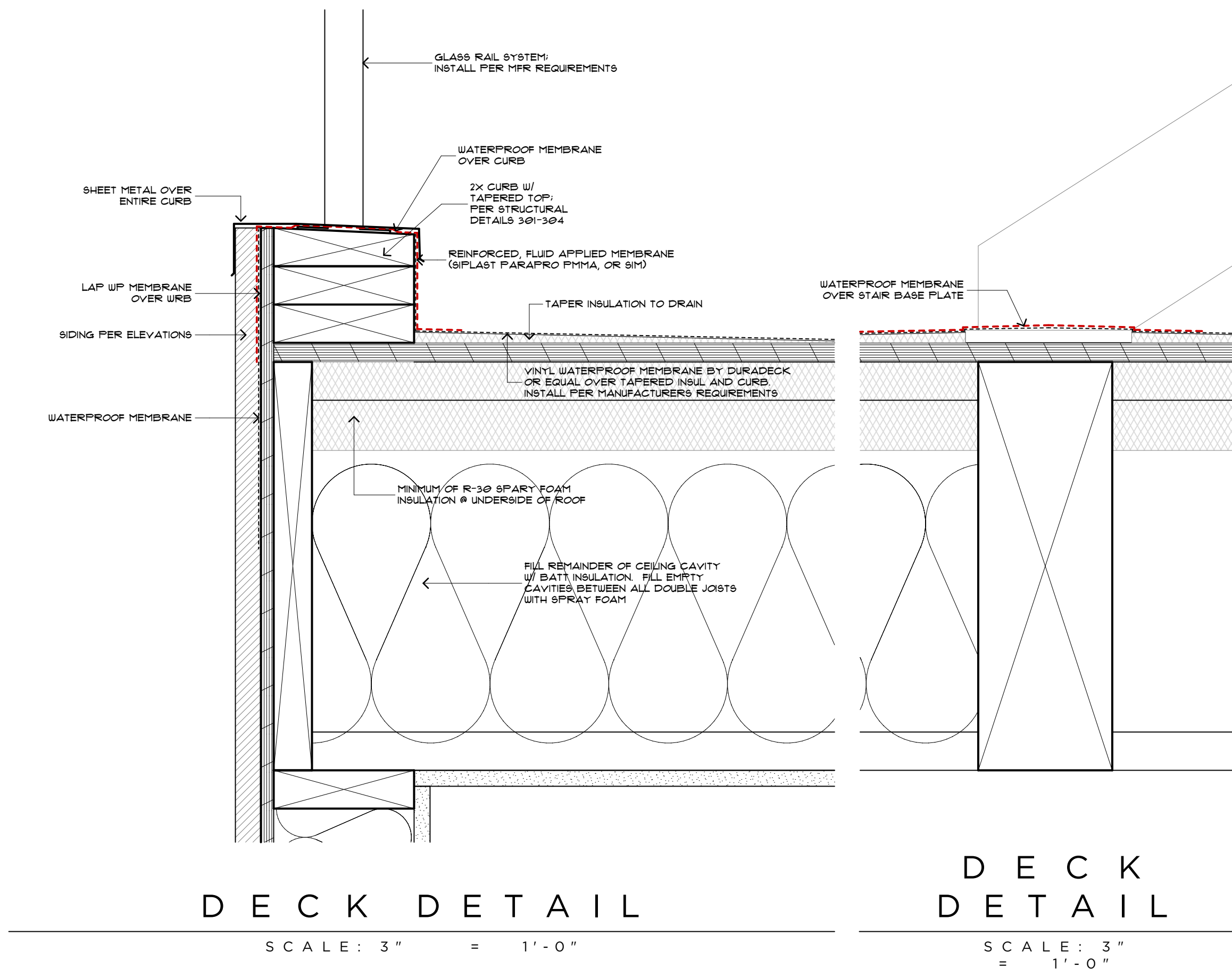

ARCHITECTURAL OUVERS 266 W Mitchell Ave - Cincinnati, OH 45232 PH: (888) 568-8371 Fax: (888) 568-8370	PROJECT CONTRACTOR		DRAWING TYPE	TECHNICAL SHEET	DRAWING TITLE	SS MOUNTING OPTIONS
	ARCHITECT		DATE	9/2017		

SUNSHADE DETAIL

SCALE: 1" = 1'-0"

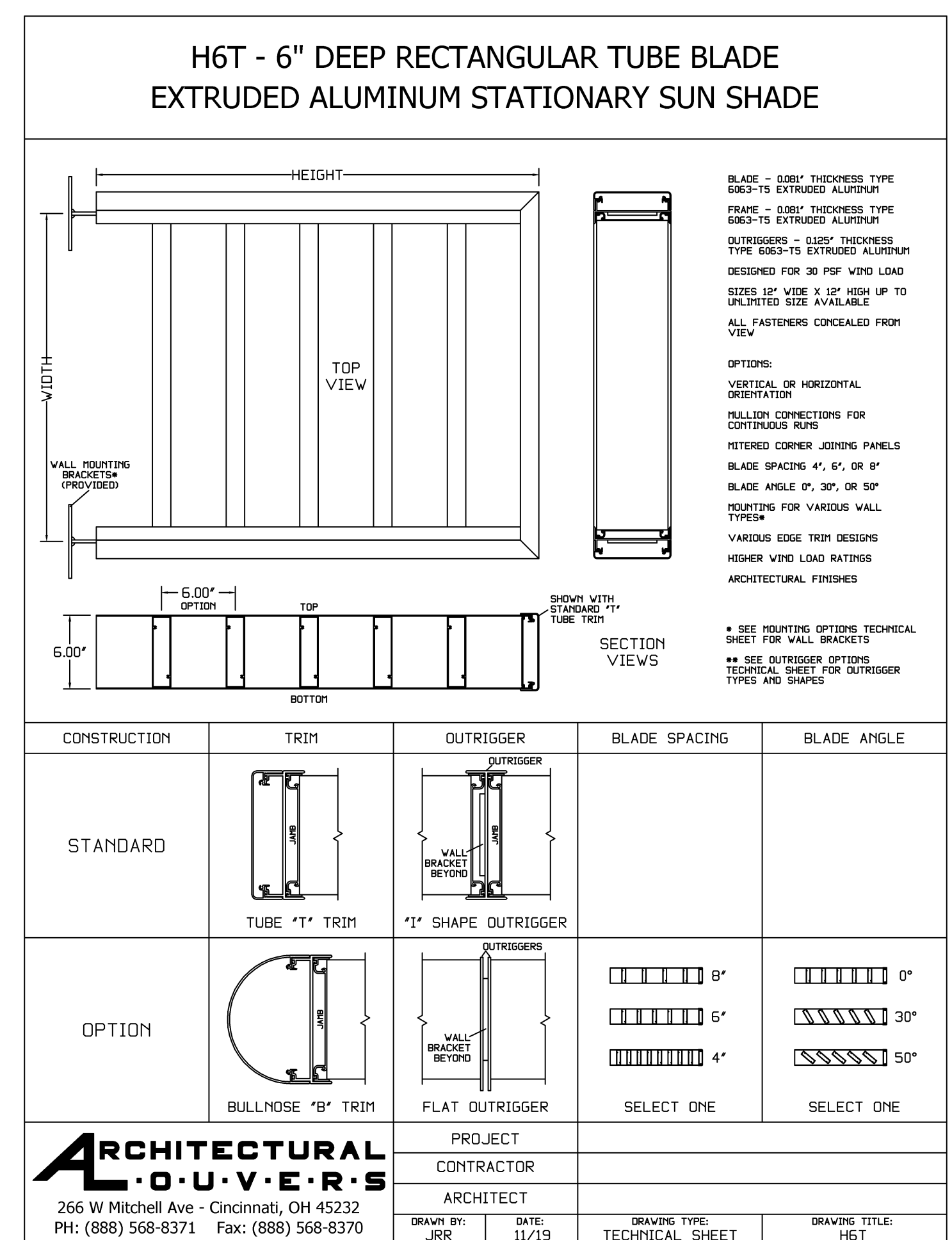

ARCHITECTURAL OUVERS 266 W Mitchell Ave - Cincinnati, OH 45232 PH: (888) 568-8371 Fax: (888) 568-8370	PROJECT CONTRACTOR		DRAWING TYPE	TECHNICAL SHEET	DRAWING TITLE	H6T
	ARCHITECT		DATE	11/19		

SUNSHADE DETAIL

SCALE: 1" = 1'-0"



MERCER RESIDENCE
6950 SE MAKER ST
MERCER ISLAND, WA

DETAILS

RELEASE
21 MARCH 2022
PERMIT CORRECTIONS
20 FEBRUARY 2023
PERMIT CORRECTIONS
2 JUNE 2023

A 4.2

MAKER AVE
MERCER ISLAND, WA

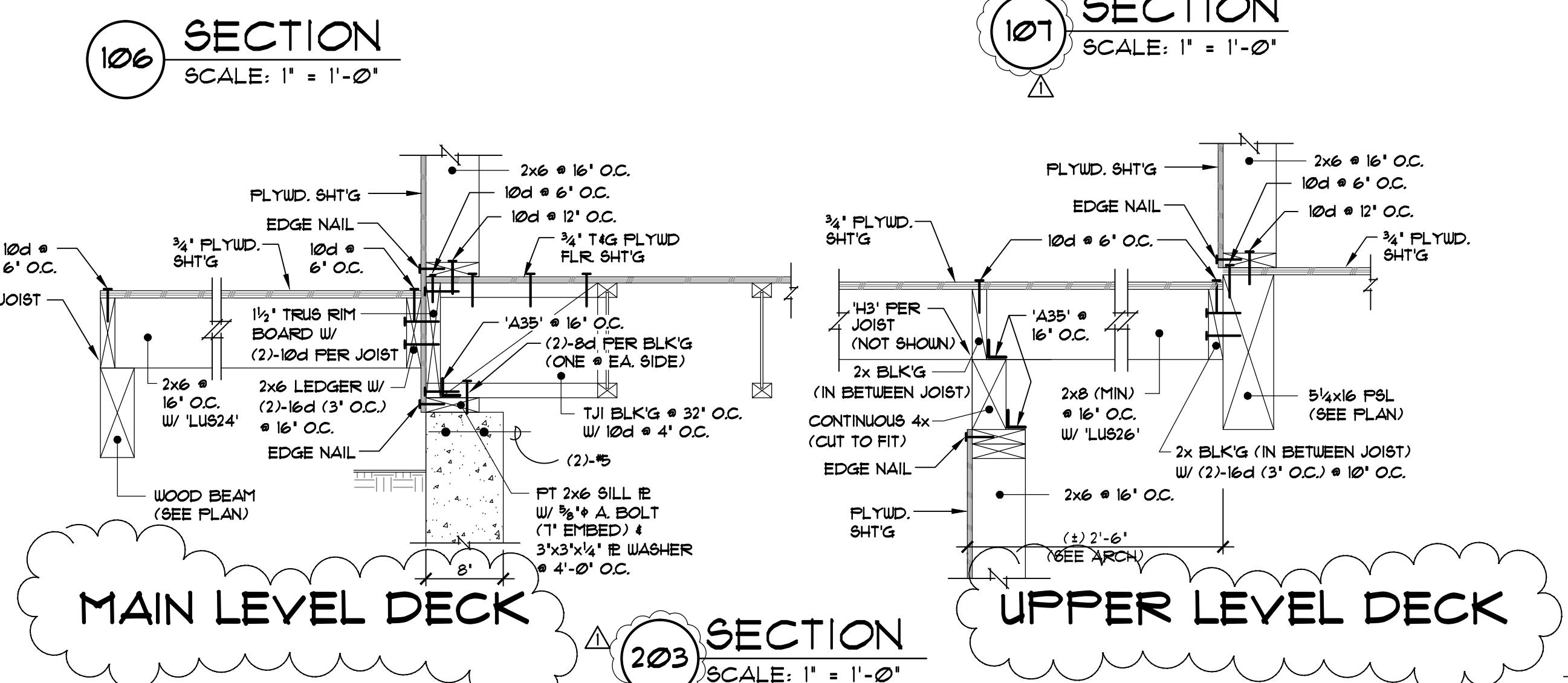
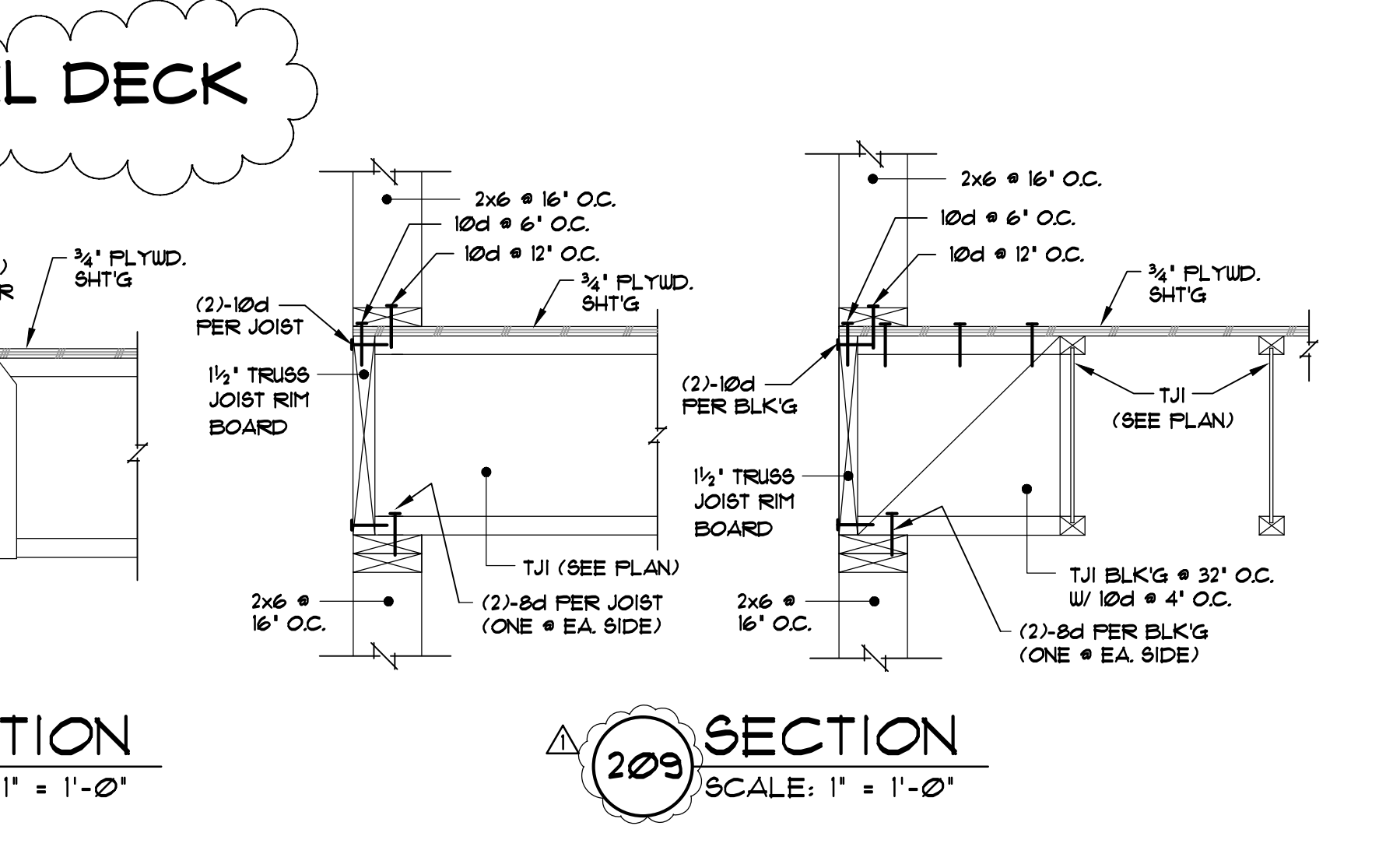
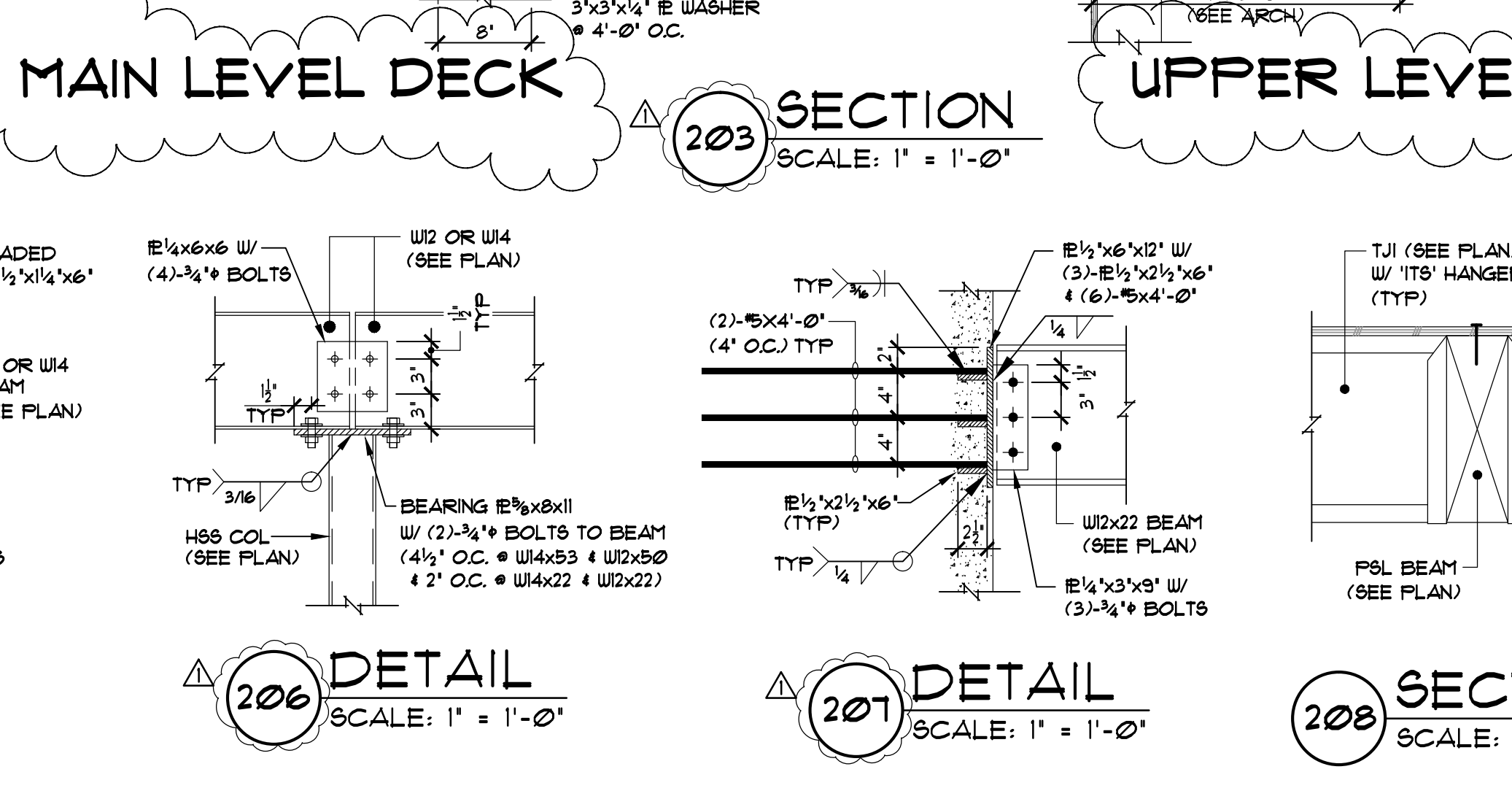
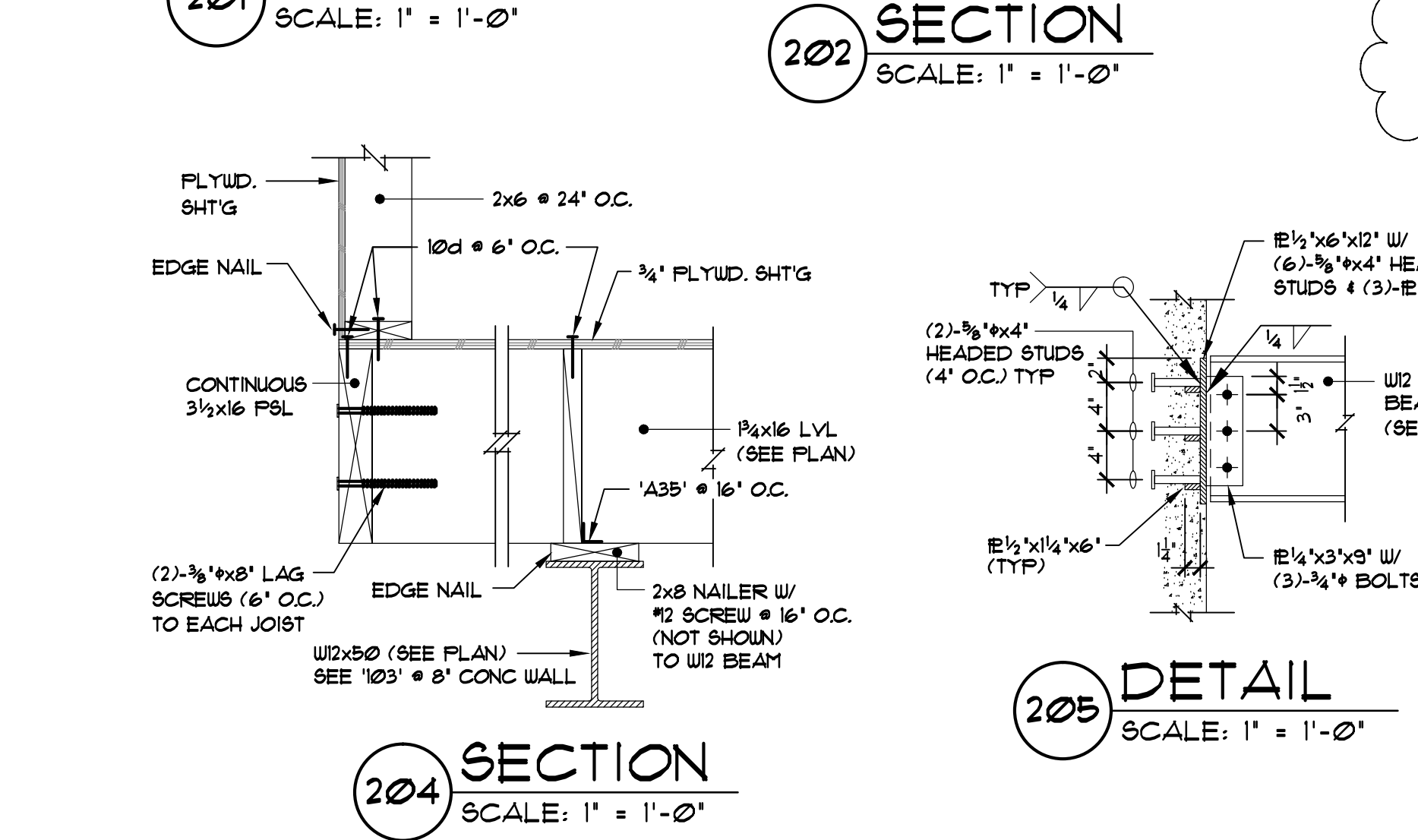
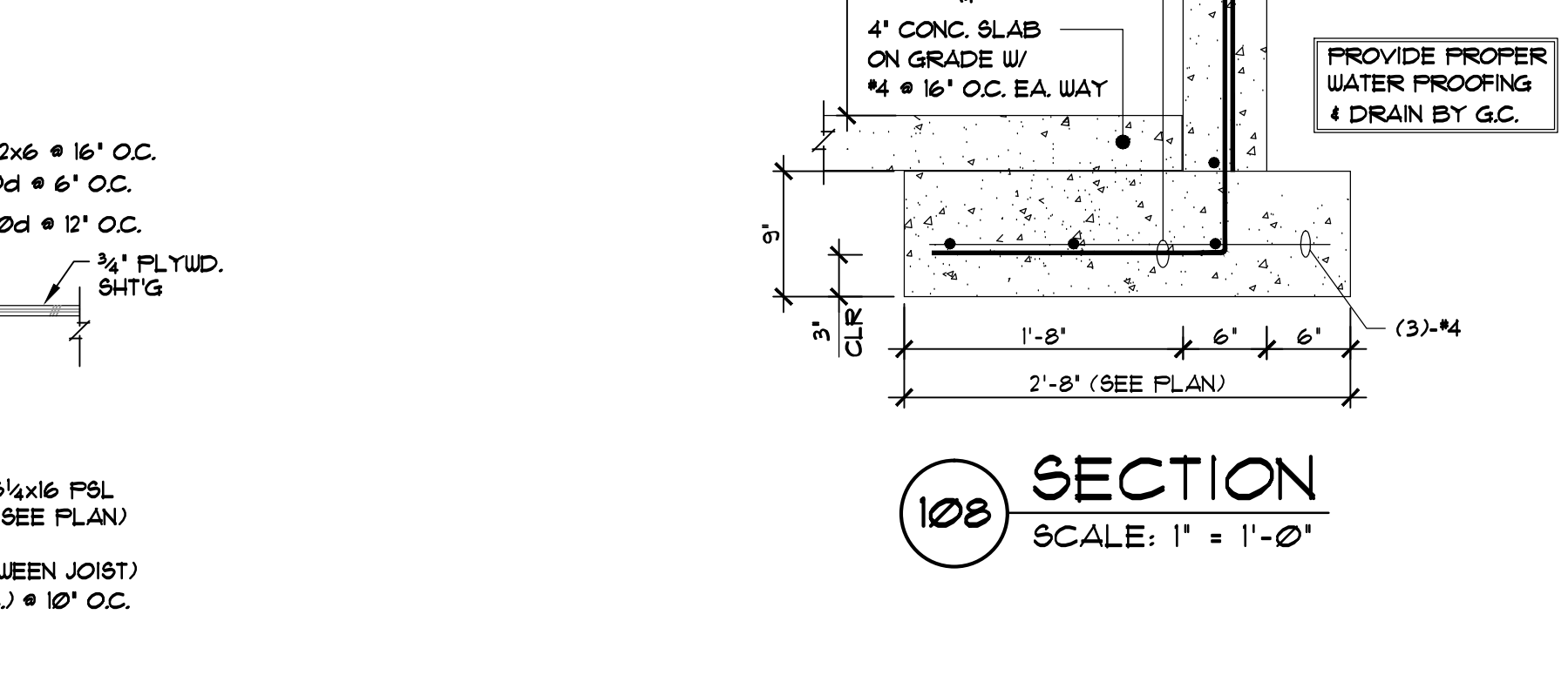
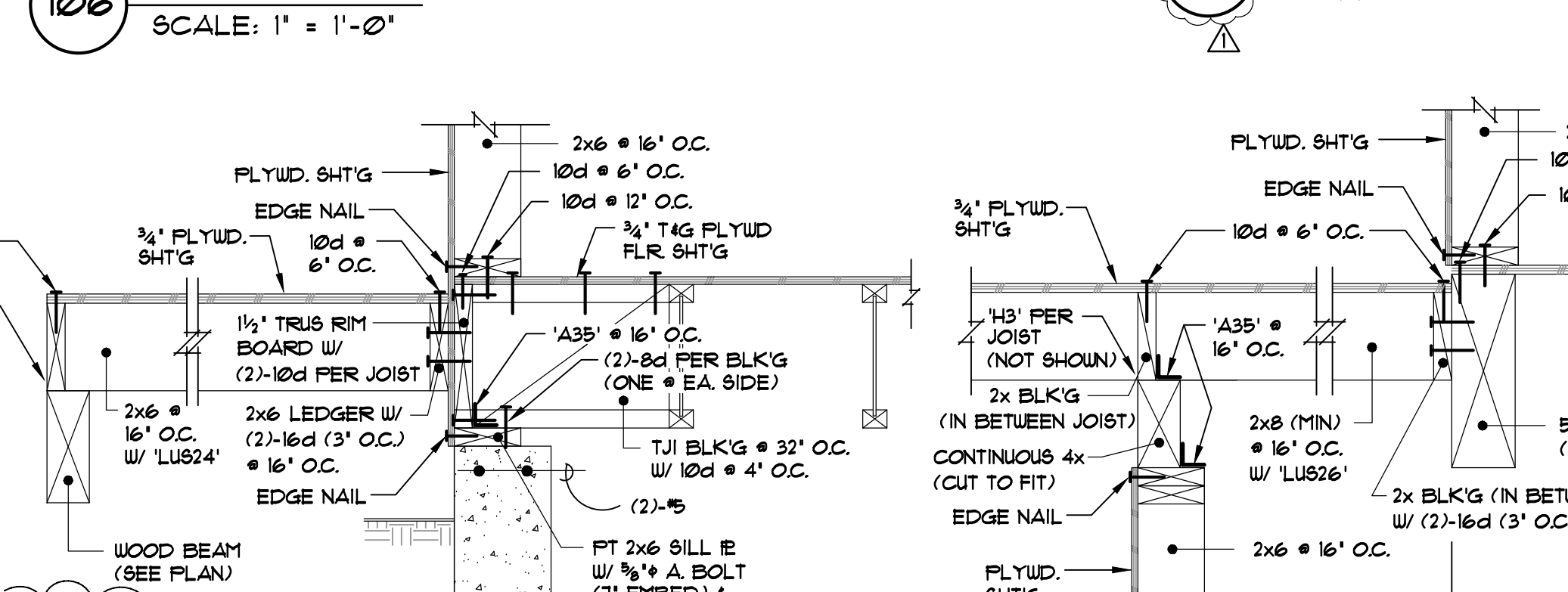
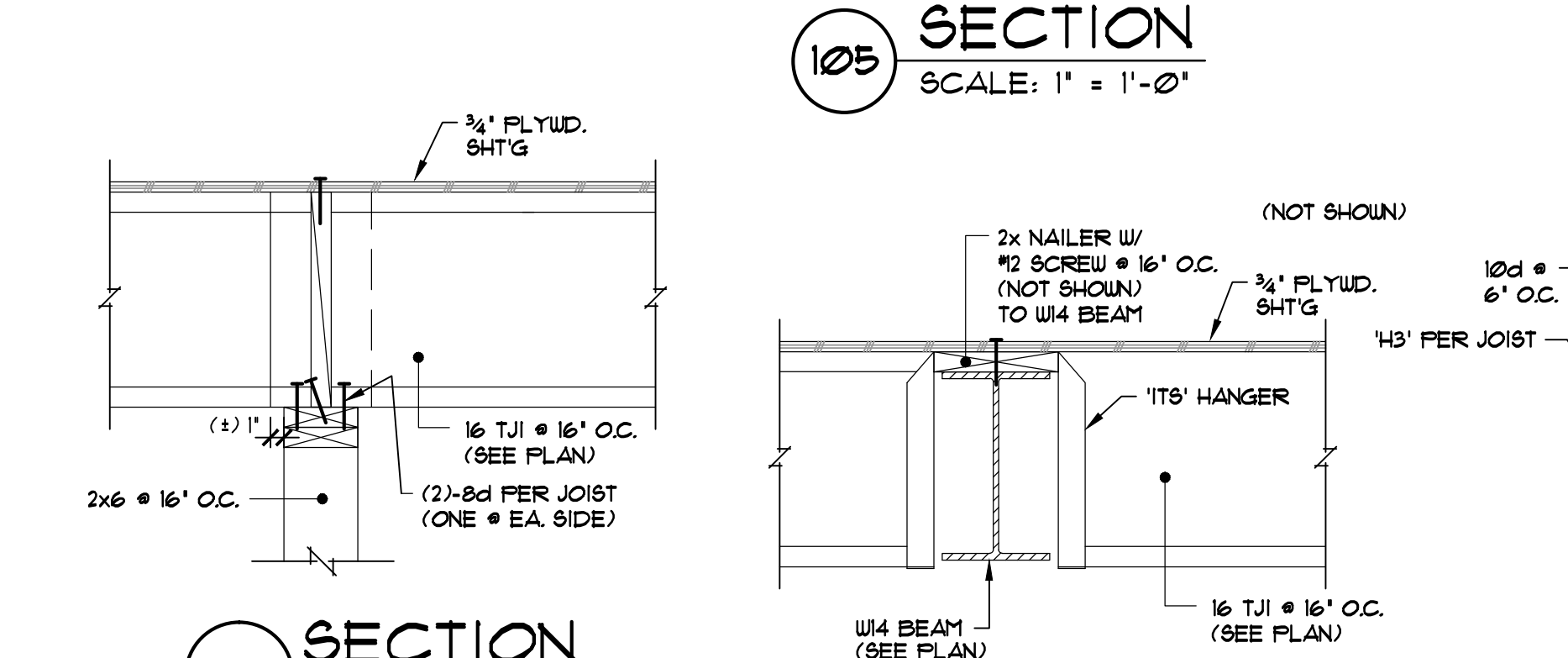
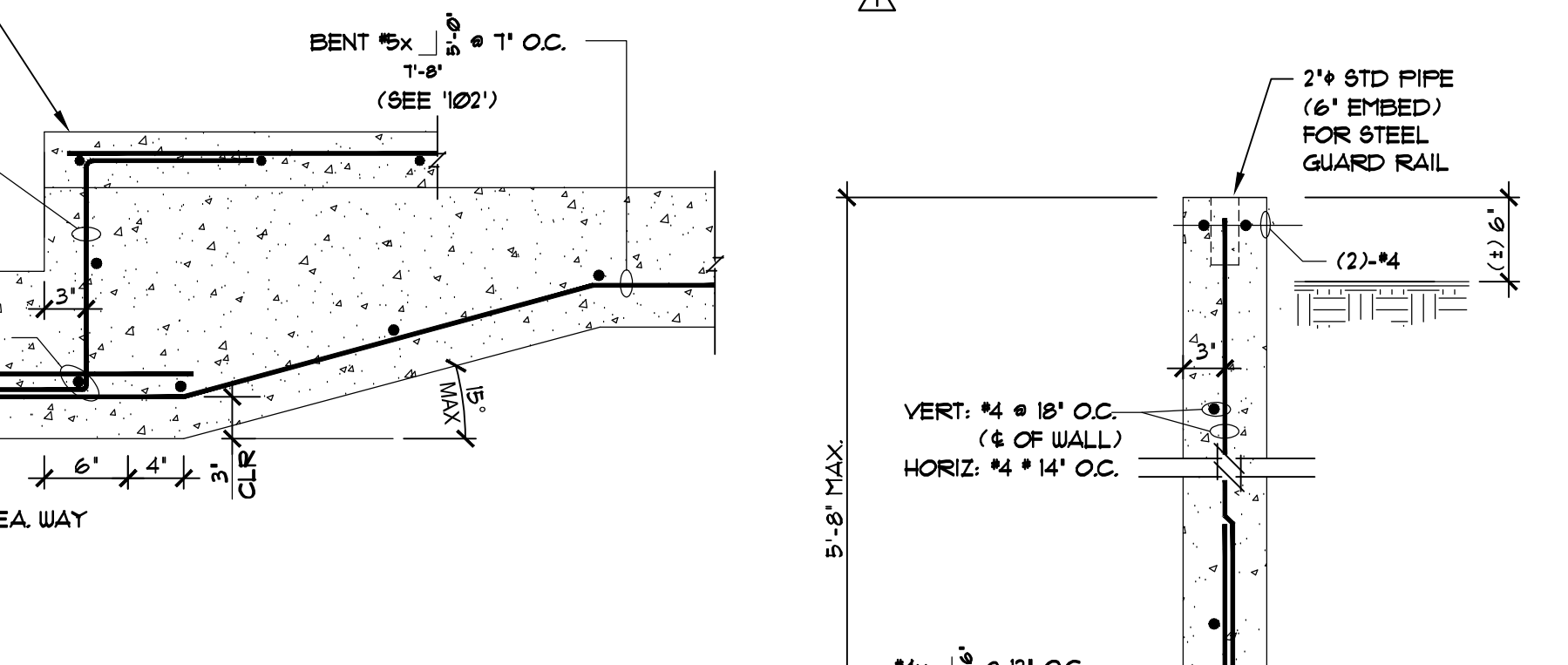
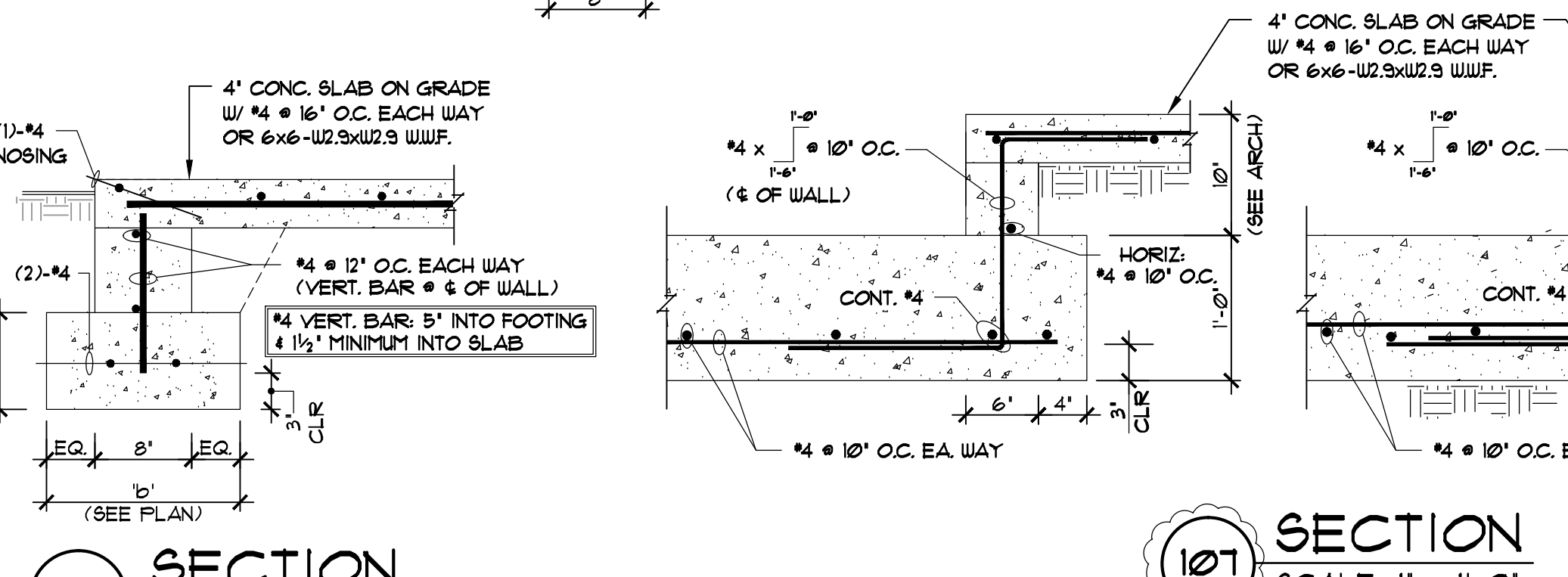
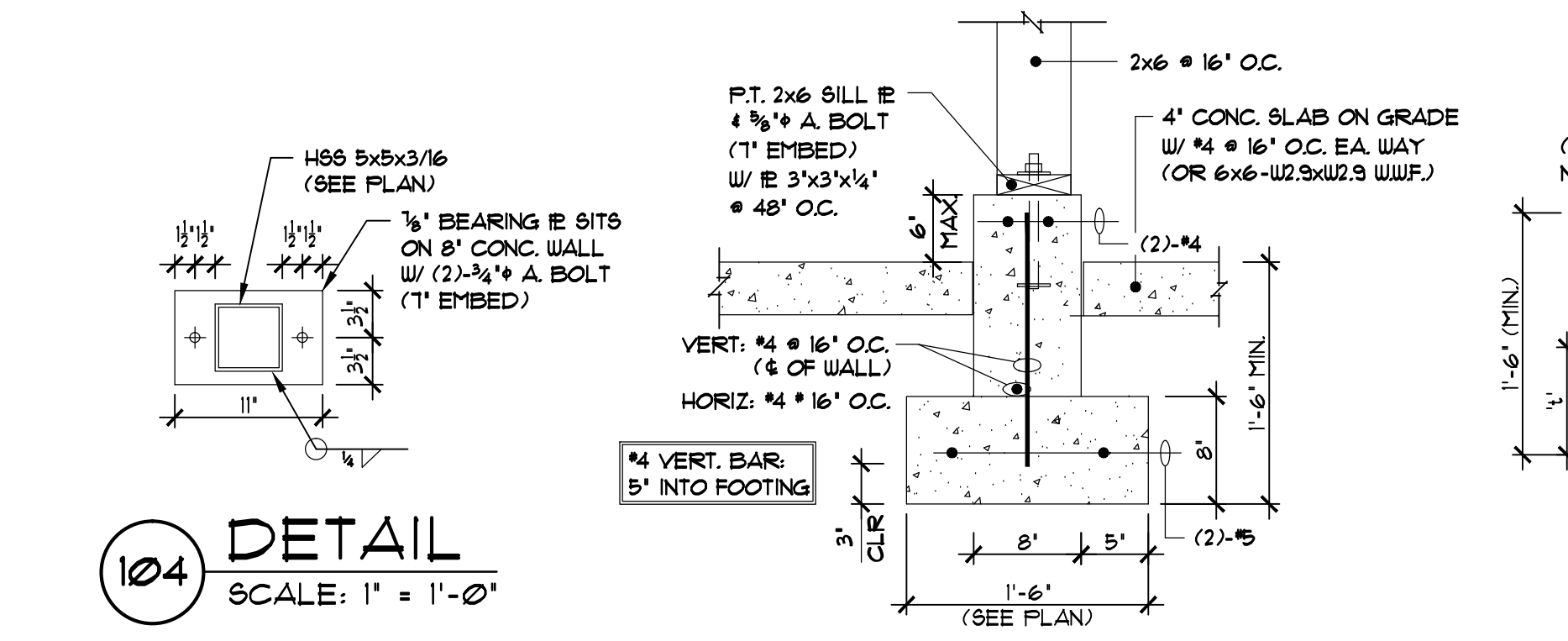
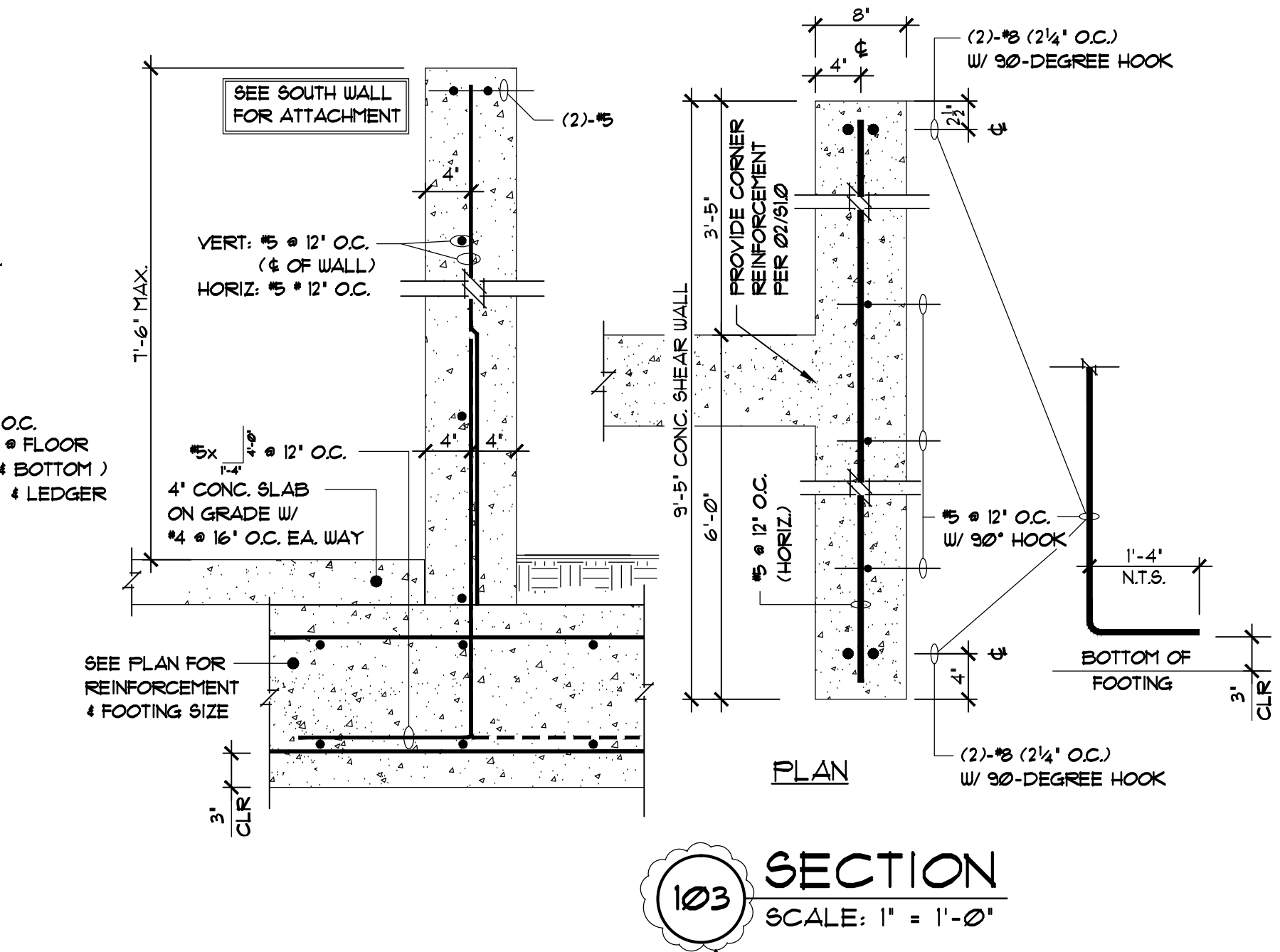
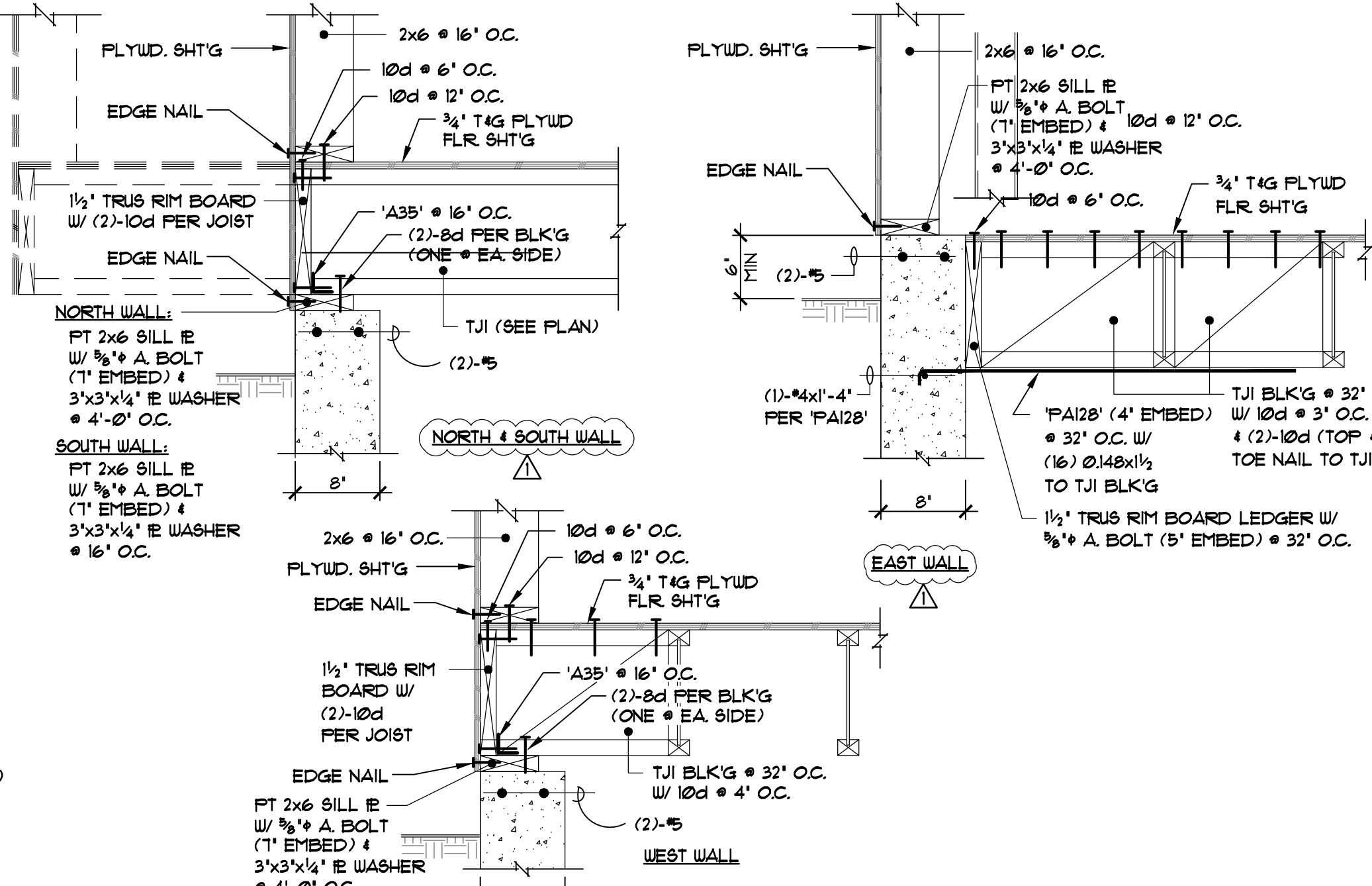
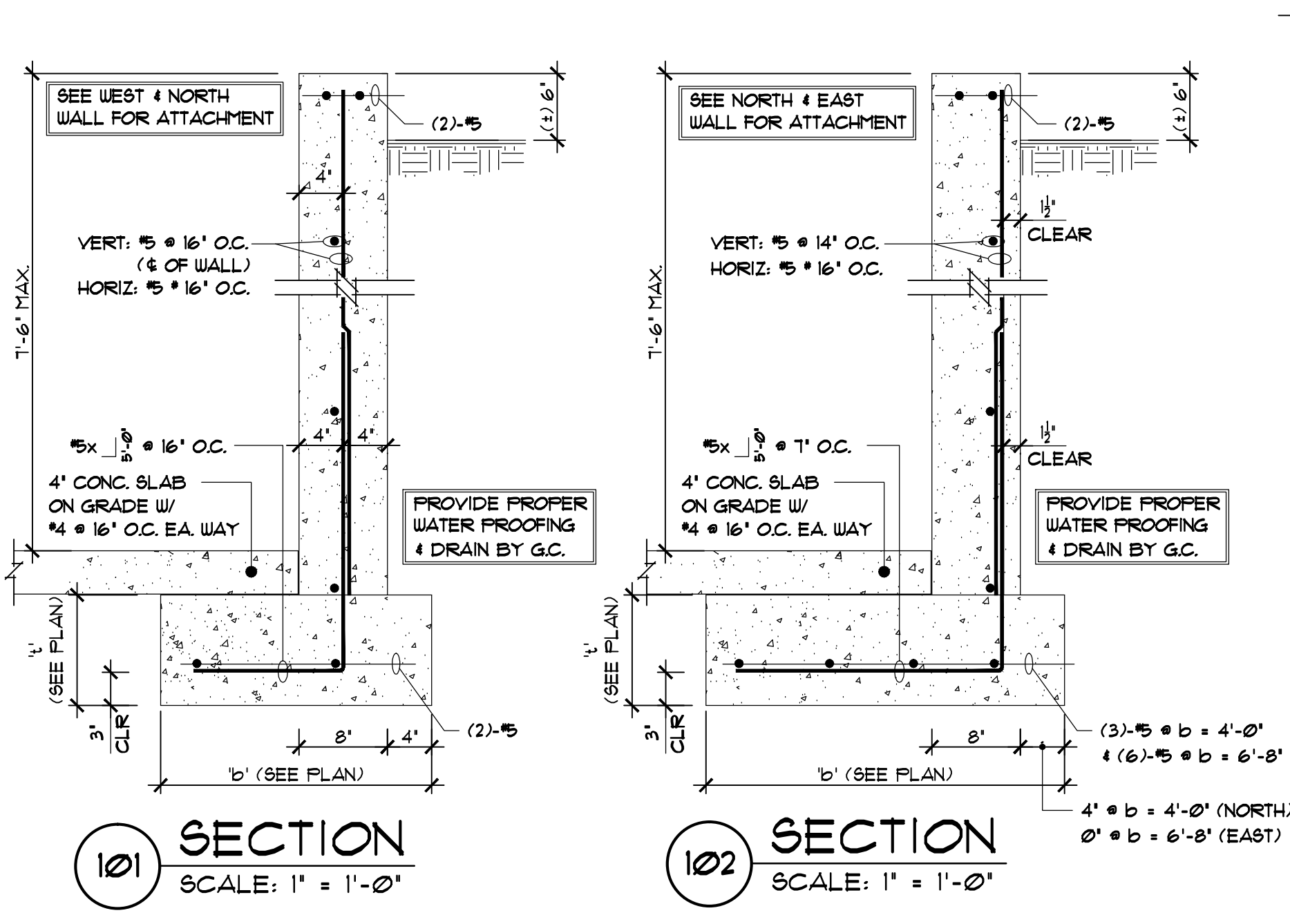

REVISIONS:

NO.	DATE	DESCRIPTIONS
1	2/2/2023	CORRECTIONS

D.S Engineering
Consulting Structural Engineers
3121 147th Place SE
Mill Creek, WA 98012
T: 425-338-4776

06/22/2022

PROJECT:
MERCER RESIDENCE
6950 SE MAKER STREET
MERCER ISLAND, WA 98040

DATE: June 22, 2022
SCALE: SEE PLAN
JOB NO.: 22-300
DRAWN: D.S.
CHECK: D.S.

SHEET TITLE
SECTIONS & DETAILS

SHEET
S1.1

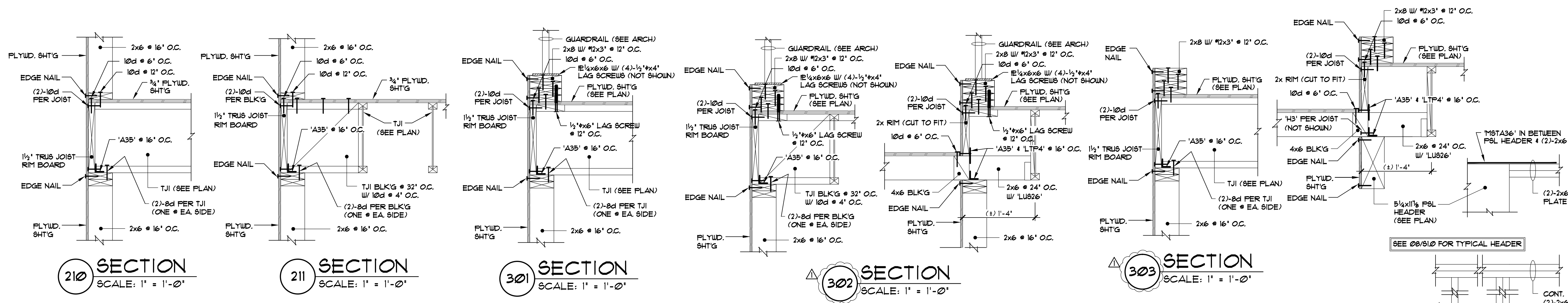

210 SECTION
SCALE: 1" = 1'-0"

211 SECTION
SCALE: 1" = 1'-0"

301 SECTION
SCALE: 1" = 1'-0"

302 SECTION
SCALE: 1" = 1'-0"

303 SECTION
SCALE: 1" = 1'-0"

304 SECTION
SCALE: 1" = 1'-0"

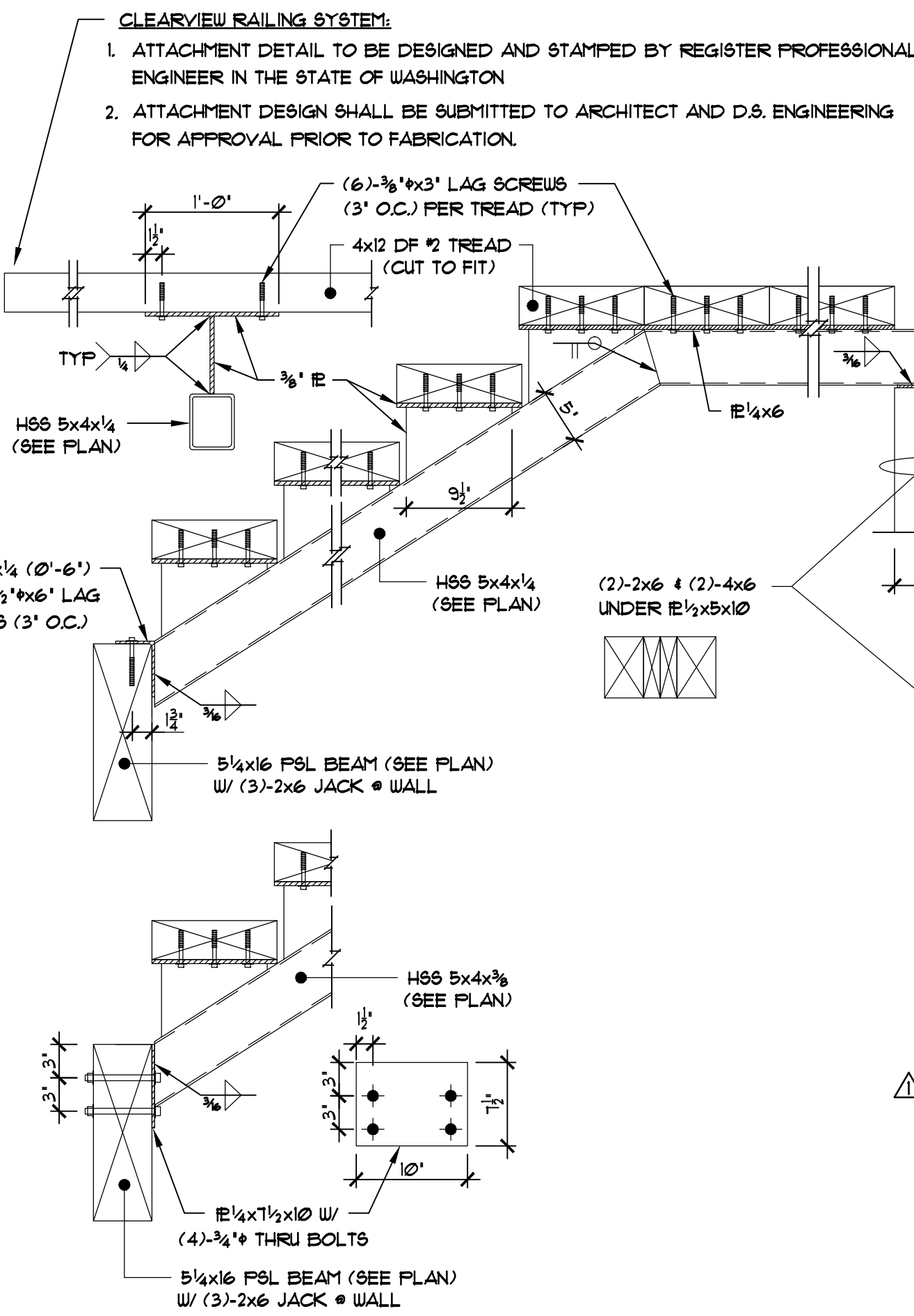

STAIR (INTERIOR)
SCALE: 1" = 1'-0"

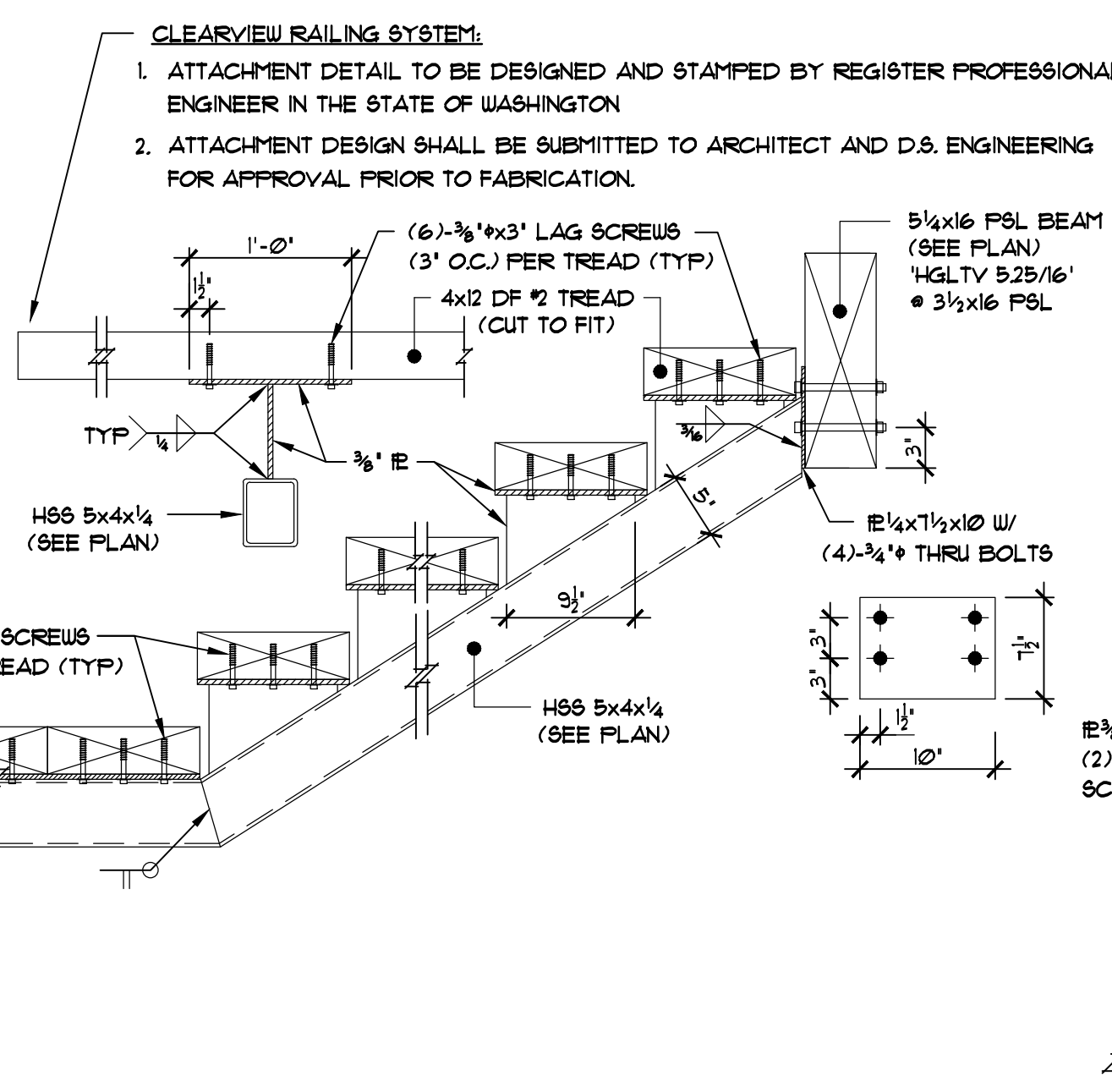

STAIR (EXTERIOR)
SCALE: 1" = 1'-0"

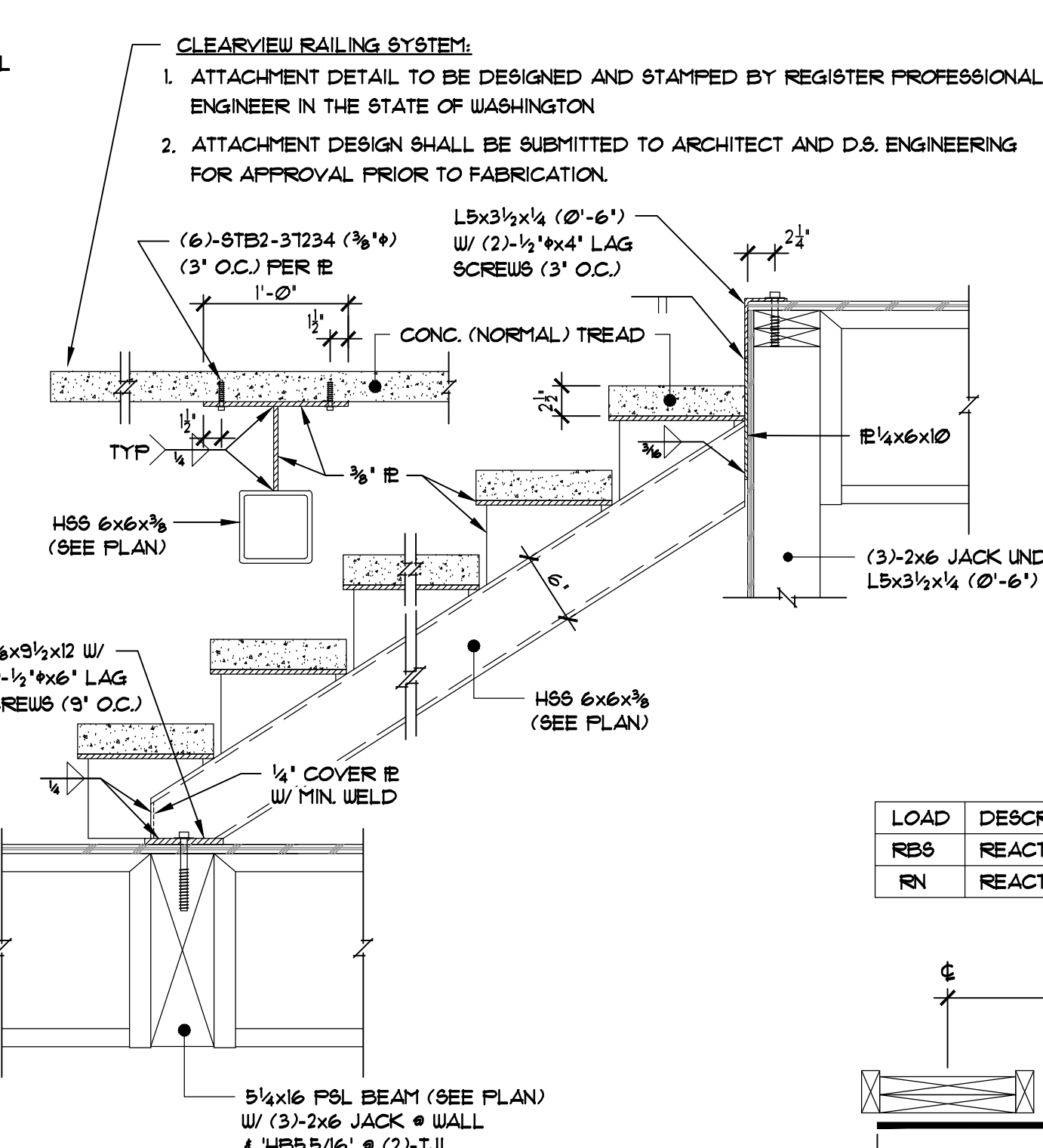

ATTCHMENT @ ELEVATOR
SCALE: 1" = 1'-0"

LOAD	DESCRIPTION	Lbf
RBS	REACTION TO BUFFER OR SAFETY ENGAGEMENT	4,671 •
RN	REACTION DUE TO NORMAL OPERATION	7,886 •

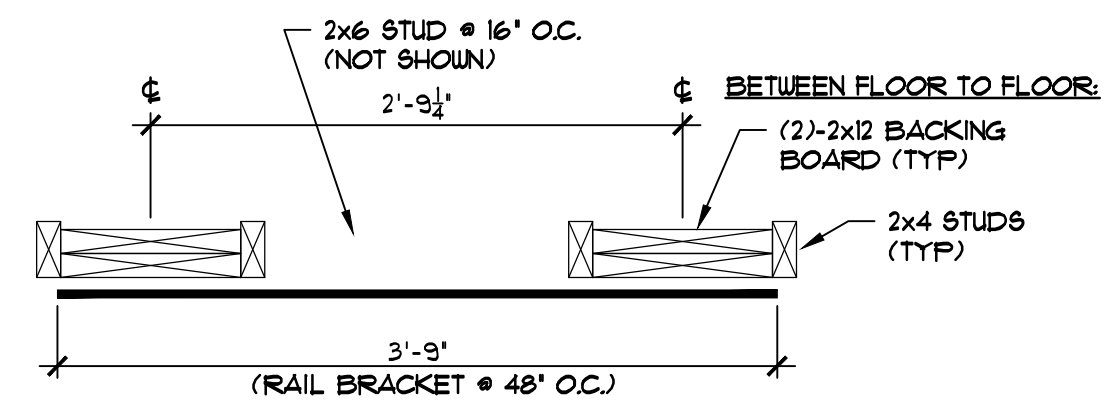

REVISIONS:

NO.	DATE	DESCRIPTIONS
2	2/2/2023	CORRECTIONS
3	3/14/2023	CORRECTIONS

D.S. Engineering
Consulting Structural Engineers
3121 147th Place SE
Mill Creek, WA 98012
T: 425-338-4776



PROJECT:
MERCER RESIDENCE
6950 SE MAKER STREET
MERCER ISLAND, WA 98040

DATE: June 22, 2022
SCALE: SEE PLAN
JOB NO.: 22-300
DRAWN: D.S.
CHECK: D.S.

SHEET TITLE
SECTIONS
& DETAILS

SHEET
S1.2

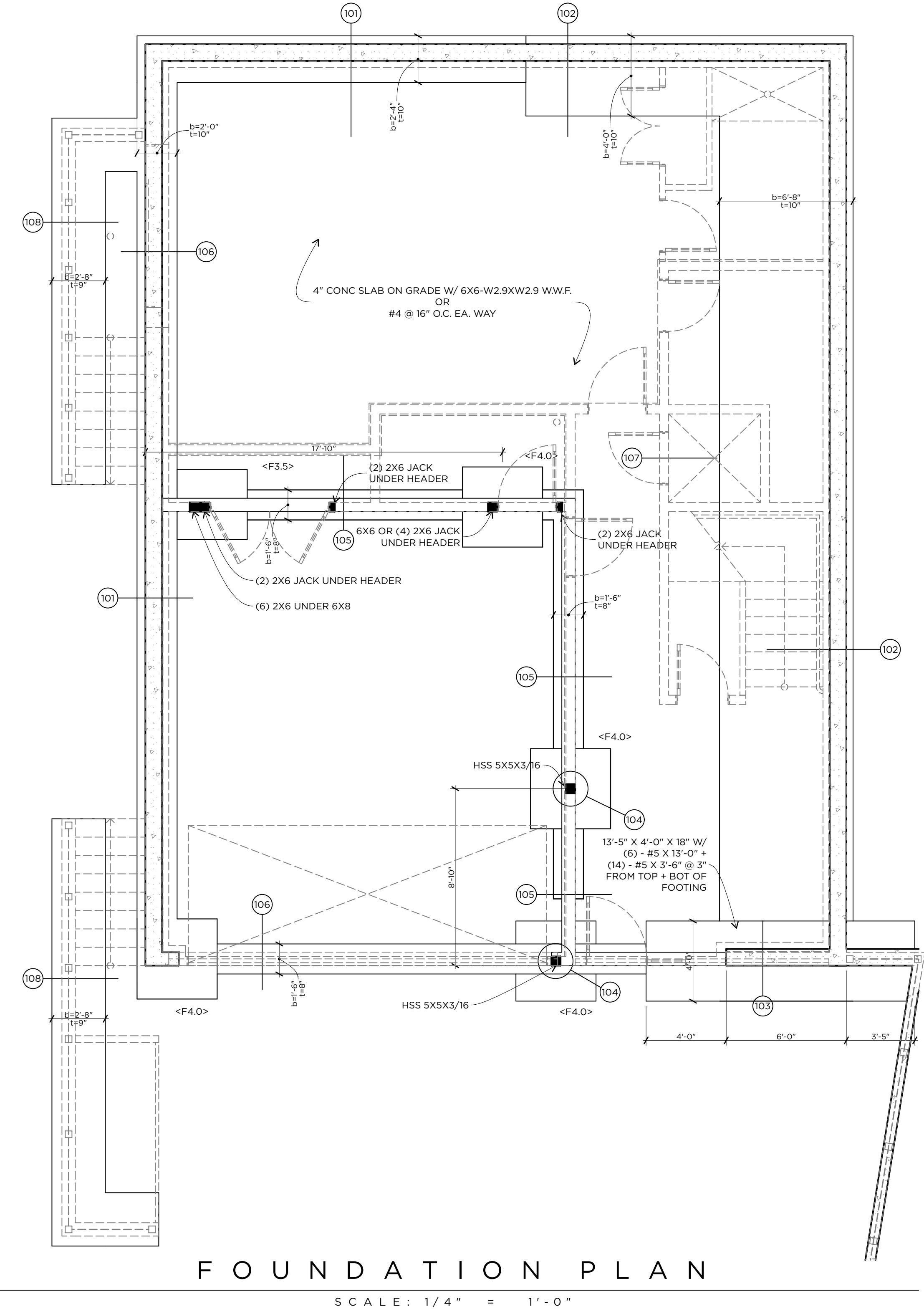
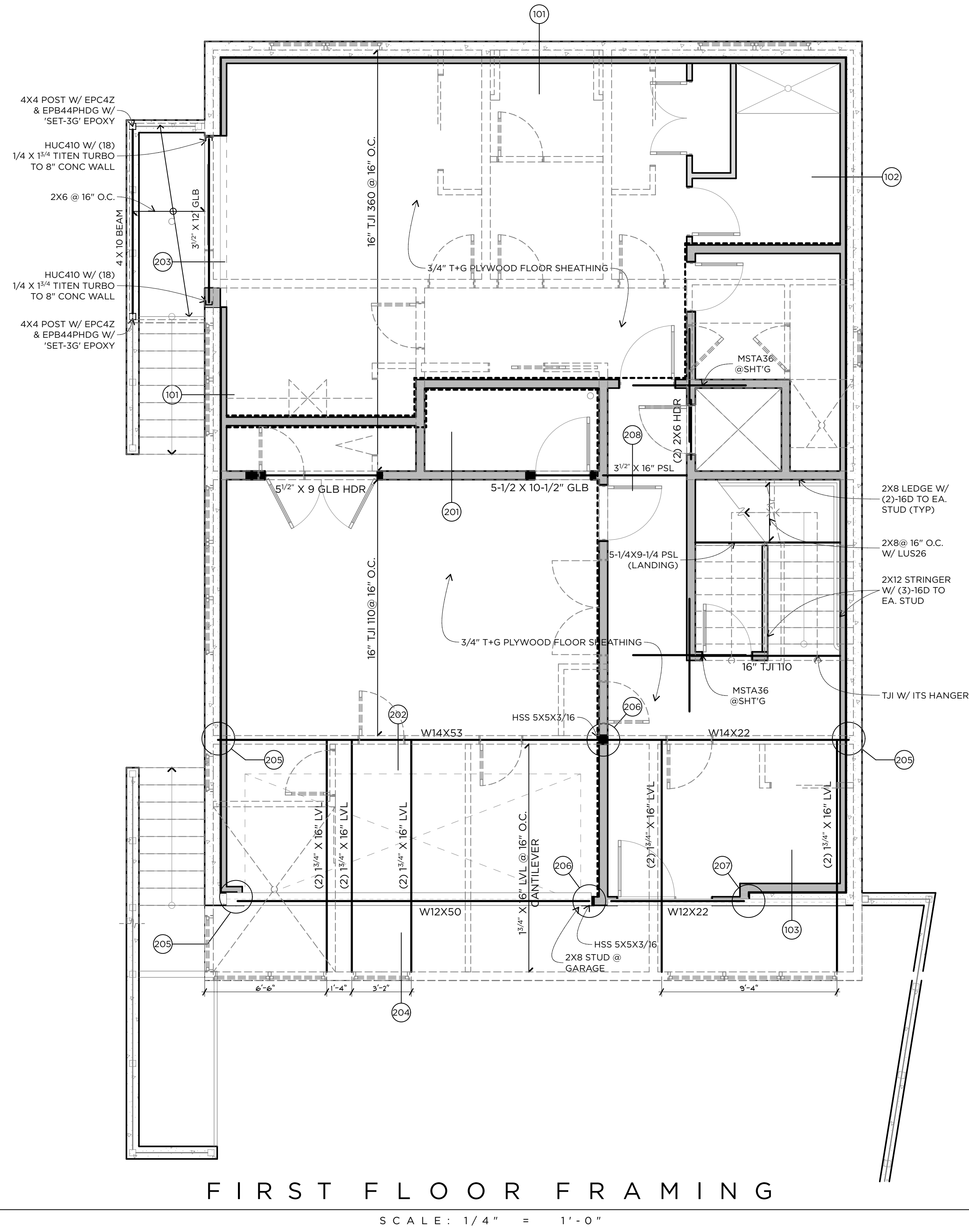

MERCER RESIDENCE
6950 SE MAKER ST MERCER ISLAND, WA

FOUNDATION + FIRST FLOOR FRAMING PLANS

RELEASE
10 MAY 2022
20 FEBRUARY 2023
PERMIT CORRECTIONS
2 JUNE 2023



MERCER RESIDENCE
6950 SE MAKER ST MERCER ISLAND, WA

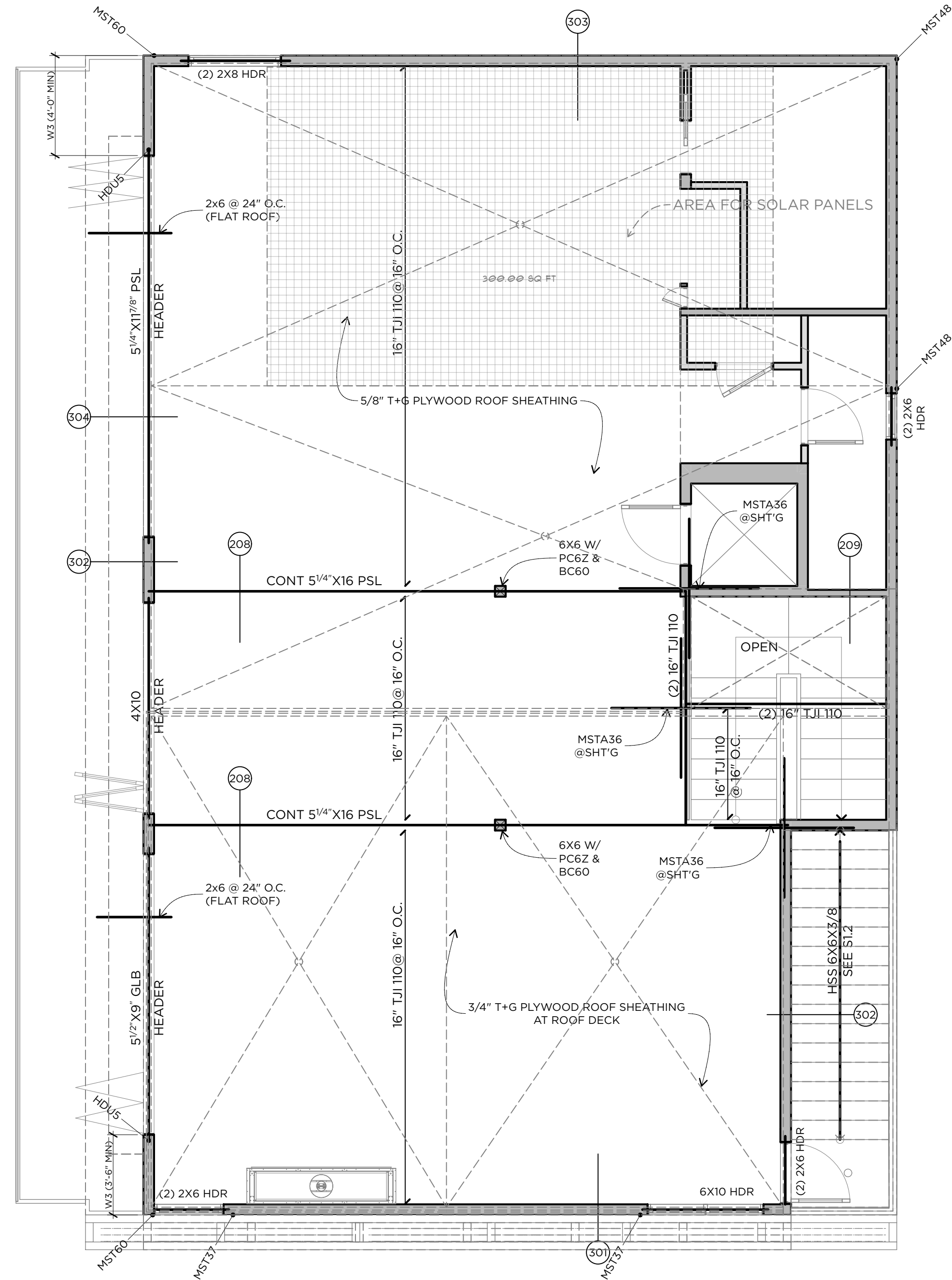

ROOF FRAMING

SCALE: 1/4" = 1'-0"

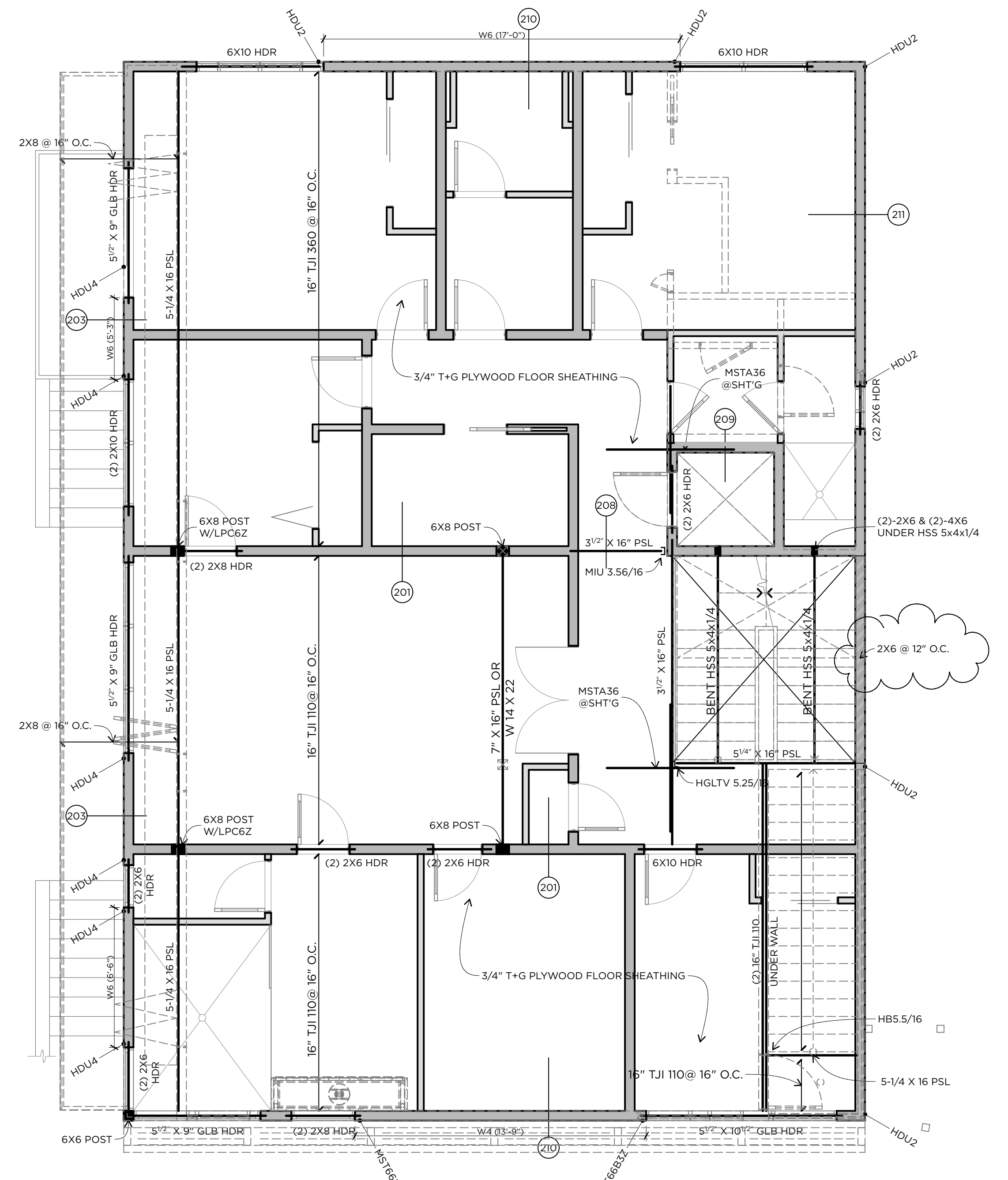

SECOND FLOOR FRAMING

SCALE: 1/4" = 1'-0"

SECOND FLOOR +
ROOF FRAMING
PLANS

RELEASE
10 MAY 2022
20 FEBRUARY 2023
PERMIT CORRECTIONS
2 JUNE 2023

EXHIBIT E

DSG Policy Memorandum
Administrative Interpretation
#DCI12-004



DEVELOPMENT SERVICES GROUP

9611 SE 36TH ST., MERCER ISLAND, WA 98040
(206) 275-7605

TO: DSG Staff
FROM: Scott Greenberg, Development Services Group Director
DATE: January 9, 2013
RE: Interpretation of Existing Grade for Calculation of Basement Area Exclusion
CC: City Attorney

ISSUES

The Mercer Island City Code allows for the exclusion from gross floor area calculations of basement areas below existing grade. When a lot has been developed, it is difficult to establish existing grade, which is the grade prior to development. Administrative Code Interpretation #04-04 addresses this issue as it relates to Average Building Elevation. The purpose of this Administrative Code Interpretation is to clarify existing grade as it pertains to basement area exclusion from Gross Floor Area calculations.

FINDINGS

1. The Code Official, pursuant to MICC 19.15.010(C)(5)(a) of the Mercer Island City Code (MICC), is authorized to make this administrative interpretation subject to the procedures established by MICC 19.15.020(L).
2. Pursuant to Mercer Island City Code (MICC) 19.02.010(E)(1), "the gross floor area of a single-family structure shall not exceed 45 percent of the lot area." MICC 19.16.010(G) defines "gross floor area" as:

The total square footage of floor area bounded by the exterior faces of the building.

1. *The gross floor area of a single-family dwelling shall include:*
 - a. *The main building, including but not limited to attached accessory buildings.*
 - b. *All garages and covered parking areas, and detached accessory buildings with a gross floor area over 120 square feet.*
 - c. *That portion of a basement which projects above existing grade as defined and calculated in Appendix B of this development code.*
3. Appendix B to Title 19 allows an applicant to exclude "that portion of the basement floor area from the Gross Floor Area which is below grade." Appendix B clarifies that

the basement exclusion area must be below “existing grade.” Existing grade is defined by MICC 19.16.010(E) as “the surface level at any point on the lot prior to alteration of the ground surface.”

4. MICC 19.16.010(A) defines “alteration” as “any human-induced action which adversely impacts the existing condition of the area, including grading, filling, dredging, draining, channeling and paving (including construction and application of gravel).”
5. The phrase “prior to alteration” is problematic. As discussed in Administrative Code Interpretation #04-04, in the absence of a survey of the original condition of the lot, it may be impossible to determine the degree of alteration. Complicating this issue is that many lots were altered (grading, tree removal) years prior to the original development.
6. Portions of a property typically remain undeveloped during single family residential construction, and therefore, are likely to retain the contour present before the most recent development. While it may be impossible to establish grade prior to all lot alterations, it is feasible to interpolate the approximate topographic elevations of the lot previous to the most recent development.
7. MICC 19.16.010(E) stipulates that existing grade is measured from the surface level at any point on the ground surface. While the MICC does not define “ground”, the Merriam-Webster dictionary states that “ground” can be defined as “the surface of the earth.”
8. Appendix B of the MICC states that for the purpose of establishing basement area exclusion, “wall segment coverage” is measured on the exterior walls.

CONCLUSIONS

1. Without concrete evidence or verification from a previous survey document, as accepted by the City Code Official, the existing grade underlying the existing structure will be used as the elevation for the proposed development.
2. Existing grade, for the purpose of calculating basement area exclusion without a survey of the pre-development conditions, shall be interpreted as the elevation of a point on the surface of the earth immediately adjacent to or touching a point on the exterior wall of a proposed structure.
3. If a current survey document is available, the applicant may establish existing grade by interpolating elevations within the proposed footprint from existing elevations outside of the proposed footprint. The survey document must be prepared by either a Washington registered civil engineer or land surveyor, and must be accepted by the City Code Official.
4. The final determination for existing grade on a lot shall be the decision of the Code Official.

DSG Policy Memorandum
Administrative Interpretation
#04-04



DEVELOPMENT SERVICES GROUP
9611 SE 36TH St., Mercer Island, WA 98040
(206) 236-5300

TO: DSG Staff

FROM: Richard Hart, AICP, Development Services Director

DATE: August 9, 2004

RE: Interpretation of average building elevation prior to any development

The Code Official under section 19.15.010 (D) (5) (a) of the Unified Land Development Code makes this administrative policy determination and interpretation of the Code of Mercer Island.

The purpose of this administrative interpretation is to clarify how the City interprets the code definition of average building elevation prior to any development.

MICC 19.16 governs definitions, including "Average Building Elevation"

After a thorough review of the existing City Unified Land Development Code (ULDC), Title 19, including definitions and references to "average building elevation", I am formally establishing the following policy relating to interpretation of "average building elevation" and interpretation of the phrase in that definition: "prior to any development", as stated in 19.16 Definitions-Average Building Elevation. This original interpretation, established in the 1990's, has been past practice of the City Development Services Department.

According to the current Title 19.16 of the ULDC, average building elevation is measured from the average grade at the midpoint of every individual wall segment, prior to any development. Determination of what point in time represents "prior to any development" becomes difficult without prior survey documents identifying topographic elevations of the land that has not been disturbed with grading, cuts or fill to place existing structures on lots. Many of these structures have existed on lots for 30-60 years or longer. In addition it is difficult to determine what, if any, grading, cut or fill has taken place 20, 30, 50 or 80 years prior to existing conditions on a lot that contains any structural development or any grading or tree cutting that might have been performed in the early 1900's when land was originally subdivided or platted, or roads were originally constructed.

Determination of existing grade “prior to any development” becomes critical when an existing structure is demolished for replacement with a new structure, and the existing grade must be established for measuring the newly allowed height of the new structure. This becomes more critical when there appears to have been some minor grading, cut or fill, including construction of some retaining walls on site to provide level surfaces for a building pad or useable outdoor yard areas.

Thus, the City will interpret the existing code language and definitions to mean that, without concrete evidence or verification from a previous survey document, as determined by the City Building Official, the existing grade of an existing structure or its various wall segments on a site will be used as the elevation for measuring average building elevation “prior to any development”.

EXHIBIT F

EXHIBIT F
CONSTRUCTION PHOTOS

PHOTO 1:

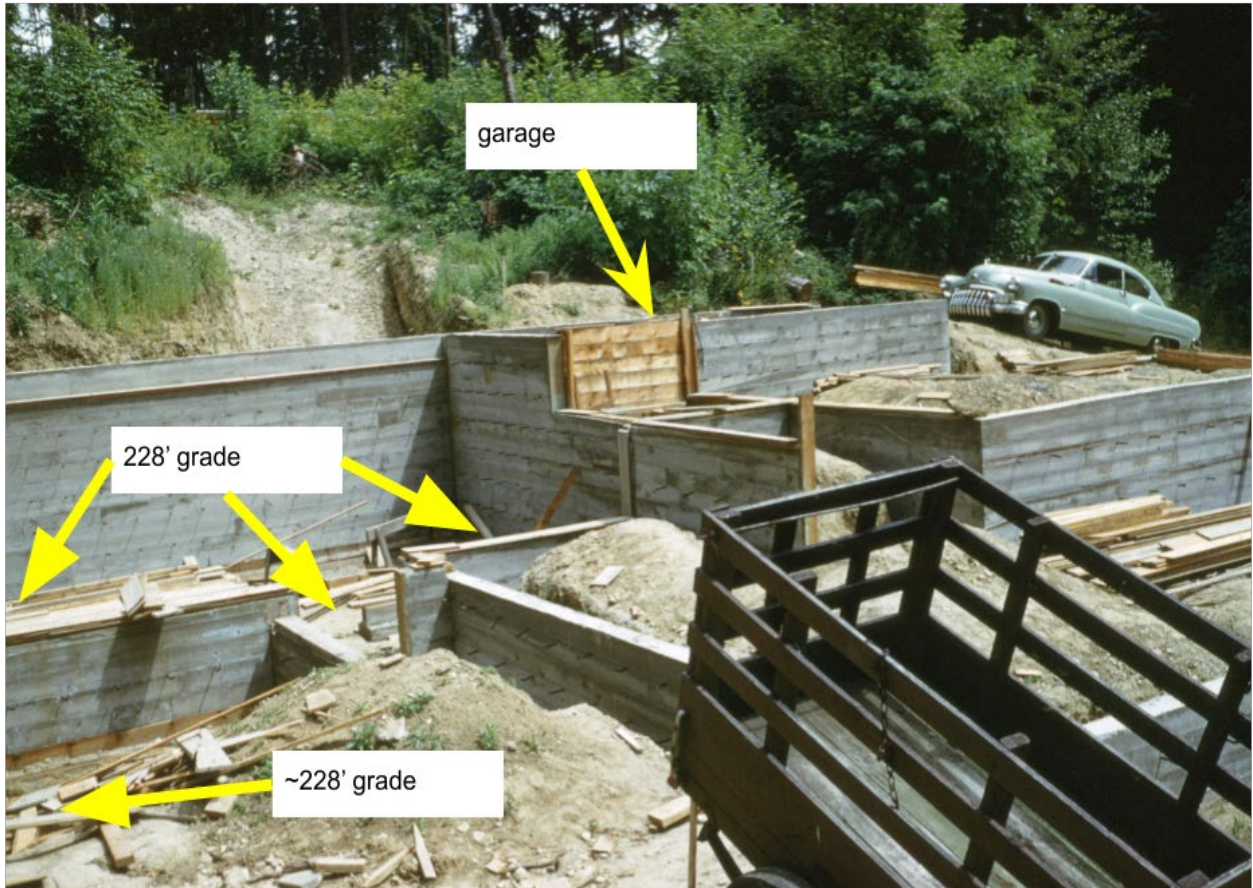

Photo taken by Greg Allen, son of the original builder of the existing home at 6950 SE Maker Street, Mercer Island, WA between 1952 and 1955, notated by Dan Grove.

PHOTO 2



Photo taken by Greg Allen, son of the original builder of the existing home at 6950 SE Maker Street, Mercer Island, WA between 1952 and 1955, notated by Dan Grove.

PHOTO 3

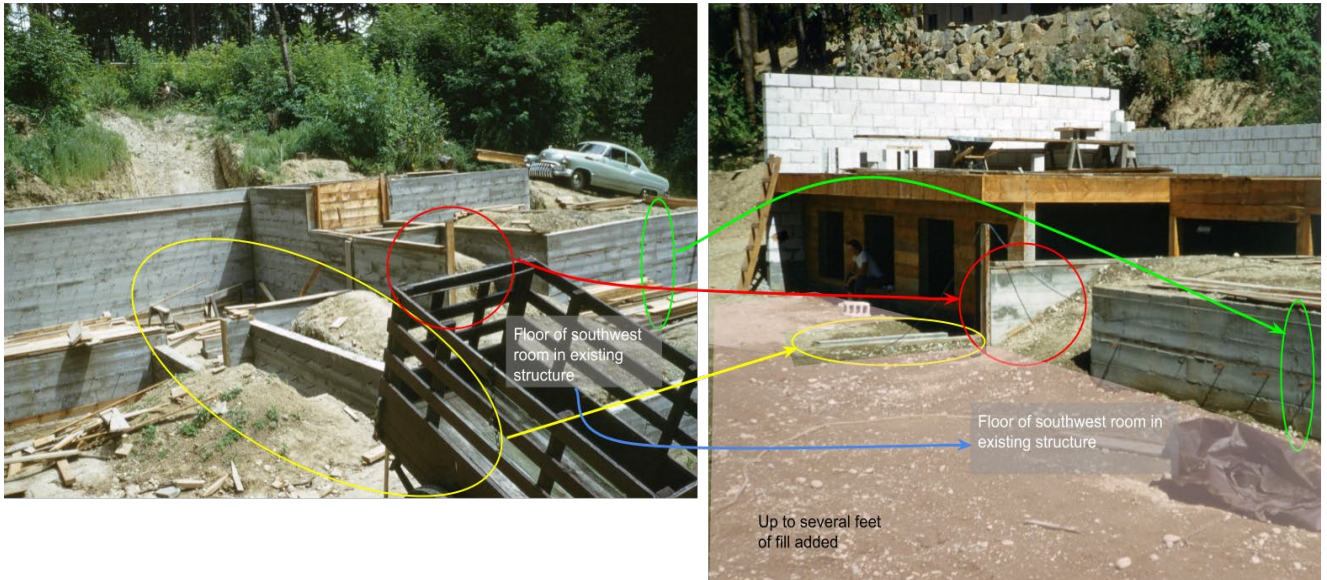

Photo taken by Greg Allen, son of the original builder of the existing home at 6950 SE Maker Street, Mercer Island, WA between 1952 and 1955, notated by Dan Grove.

These images show construction of the existing house, looking towards the west. They show large amounts of fill added between the image on the left (earlier) and the image on the right (later).

EXHIBIT G



August 14, 2023

Molly McGuire, Planner
City of Mercer Island – Community Planning & Development
9611 Southeast 36th Street
Mercer Island, Washington 98040
Via: Email

RE: 6950 Southeast Maker Street, Mercer Island, WA 98040

Dear Molly,

As requested, I have reviewed the following surveys:

- Topographic & Boundary survey of 6950 SE Maker Street, performed by Terrane under job number 2100007, dated August 28, 2022.
- Topographic Survey of “Pederson Residence”, performed by D.R. Strong Consulting Engineers, drawing number 89-848, dated May 1989, for property abutting to the north of 6950 SE Maker Street.
- Topographic Survey of 7075 SE Maker Street, performed by W.M. Marshall under job number 4222, dated August 21, 2005, for property to the south and opposing side of SE Maker Street from 6950.

The Terrane Survey and the W.M. Marshall Survey show the improved state of Southeast Maker Street. While the limit of study of the D.R. Strong survey did not include Southeast Maker Street, one must consider that the performance of that survey in 1989 was decades after those grading actions taken to develop Southeast Maker Street, having occurred sometime in the 1950’s.

Each survey appears to reflect a high level of diligence and there are no observable deficiencies that might bring their reliability into question.

As with any survey drawing, these can only illustrate conditions in existence at that specific time of performance and cannot illustrate conditions that *may have existed* previously. Therefore, one cannot *assume* that *any* mapping element from these surveys reflect conditions prior to alterations of any kind. These surveys do not serve as a “snapshot” of original grade conditions and cannot be relied on for interpolation or other such formulaic determinations of any *past, original grade*.

In review of all application materials and public comments provided, no documentation seems to exist establishing the *original* grade of 6950 Maker Street. Additionally, no grading plans, road construction permitting, or as-build document sets exist within King County Roads Division records for SE Maker Street.

Therefore, considering the lack of concrete evidence of any original grade which may have preceded the current existing conditions, it is my opinion that *existing* grade, for the purposes of permitting considerations, should be the surface elevation immediately adjacent to, or touching a point on the exterior wall of a proposed structure, in accord with Conclusion 2 of Administrative Interpretation 12-004.

Thank you,

BUSH, ROED & HITCHINGS, INC.

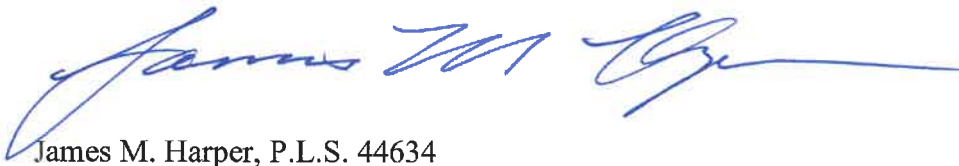

James M. Harper, P.L.S. 44634
Senior Associate / Senior Project Manager
15400 SE 30th Place, Suite 100
Bellevue, Washington 98007-6546
(206) 323-4144

EXHIBIT H

**Before THE HEARING EXAMINER for the
CITY of MERCER ISLAND**

ORDER of SUMMARY DISMISSAL

FILE NUMBER: APL23-009

APPELLANTS: Dan Grove *et al.* ¹
C/o Zachary E. Davison
Perkins Coie LLP
Seattle, WA 989101-3099
zdavison@perkinscoie.com
SERVICE BY E-MAIL (First class mail service if requested)

RESPONDENT: City of Mercer Island
Community Planning & Development
C/o Kim Adams Pratt
Madrona Law group, PLLC
14205 SE 36th Street
Suite 100, PMB 440
Bellevue, WA 98006
kim@madronalaw.com
SERVICE BY E-MAIL (First class mail service if requested)

AND

C/o Bio F. Park, City Attorney
9611 SE 36th Street
Mercer Island, WA 98040
bio.park@mercergov.org
SERVICE BY E-MAIL (First class mail service if requested)

APPLICANT: Jeffrey Almeter/Dorothy Strand
C/o David J. Lawyer
Inslee, Best, Doezie & Ryder, P.S.
10900 NE 4th Street, Suite 1500
Bellevue, WA 98004
dlawyer@insleebest.com
SERVICE BY E-MAIL (First class mail service if requested)

¹ The other appellants, listed alphabetically, are Pam Faulkner, Jim Mattison, Susan Mattison, Lynn Michael, Martin Snoey, and Brigid Stackpool.

TYPE OF CASE: Appeal from approval of a Critical Area Review 2 (Ref. file no. CAO23-011)

WHEREAS, on November 17, 2023, Respondent City of Mercer Island Community Planning & Development (“CP&D”) filed a Motion to Dismiss (“Motion”) in the above entitled matter. Pursuant to Hearing Examiner Rule of Procedure (“RoP”) 204 the City of Mercer Island Hearing Examiner (“Examiner”) granted Appellants Grove *et al.* (collectively “Grove”) and Applicants Dorothy Strand and Jeffrey Almeter (collectively “Strand”) 10 days in which to submit written responses to the Motion. Both filed timely responses; and

WHEREAS, the Examiner has considered the Motion based upon the following documents, submitted during the Motion procedure, which the Examiner has marked as exhibits for identification:

- Exhibit 9001: City of Mercer Island’s Motion to Dismiss, filed November 17, 2023, with Exhibits A – G attached
- Exhibit 9001.A: CP&D’s “Staff Report” (Decision) in CAO23-011, issued October 9, 2023
- Exhibit 9001.B: Grove Appeal, filed October 23, 2023
- Exhibit 9001.C: Tree Health Assessment by Scott Selby, Certified Arborist, prepared for Dan Grove, dated October 21, 2023
- Exhibit 9001.D: 6950 SE Maker Street report by James M. Harper, PLS, prepared for Molly McGuire, CP&D Planner, dated August 14, 2023
- Exhibit 9001.E: Administrative Interpretation 12-004, issued January 9, 2013
- Exhibit 9001.F: Administrative Interpretation 04-04, issued August 9, 2004
- Exhibit 9001.G: Review of Revised Plans for 6950 SE Maker Street by Geotech Consultants, Inc., prepared for Strand, dated June 6, 2023
- Exhibit 9002: Interlocutory Order Establishing Deadline for Responses to Motion to Dismiss, issued November 19, 2023
- Exhibit 9003: Grove et al. Response to the City of Mercer Island’s Motion to Dismiss, filed November 27, 2023, with Exhibits A – C attached
- Exhibit 9003.A: Original Grade Determination, Tseng Residence, 2720 71st Avenue SE by Liu & Associates, Inc., prepared for Sherry Tseng, dated August 3, 2017
- Exhibit 9003.B: Strand Residence – 2207-019, 6950 SE Maker Street by Lee Nyquist, PLS, prepared for CP&D, dated July 7, 2023
- Exhibit 9003.C: Geotechnical Consultation, Proposed Residence, 7100 Block, SE 35th Street by GeoEngineers, prepared for Art Pederson, dated May 9, 1989
- Exhibit 9004: Applicant Dorothy Strand’s Response in Support of Motion to Dismiss, filed November 27, 2023
- Exhibit 9005: Response Declaration of Dorothy Strand’s in Support of Motion to Dismiss, filed November 27, 2023, with Exhibits A – E attached
- Exhibit 9005.A: Arborist Report by Douglas Herrmann, Certified Arborist, prepared for Strand, June 29, 2021
- Exhibit 9005.B: Pre-construction Assessment 6950 SE Maker Street by Anthony Moran, Certified Arborist, prepared for Strand, dated August 16, 2022
- Exhibit 9005.C: Geotechnical Engineering Study and Critical Area Study by Geotech Consultants, Inc., prepared for Strand, dated March 21, 2022

Exhibit 9005.D: Photograph, 6950 SE Maker Street, February 21, 1955
Exhibit 9005.E: Existing Rockery Memo by Jeffrey Almeter, prepared on Strand's behalf for Molly McGuire, CP&D Planner, July 6, 2023

and;

WHEREAS, Washington's appellate courts recognize the right of quasi-judicial bodies to act summarily in appropriate situations.

Since Const. art. 4 and the Superior Court Civil Rules do not exclusively reserve summary procedures to the judiciary, there is no logic that compels us to consider separation of powers as a roadblock to the use of efficient judicial procedures in the field of administrative law. If there does not exist a genuine issue of material fact, there is no reason why an administrative board or agency should be denied an opportunity to handle the matter summarily, passing on the issue of law presented.

[*ASARCO, Inc. v. Air Quality Coalition*, 92 Wn.2d 685, 696-97, 601 P.2d 501 (1979), citations omitted] In *Eastlake Community Council v. City of Seattle* [64 Wn. App. 273, 276, 823 P.2d 1132 (1992)] Division I of the Court of Appeals held that even where a quasi-judicial body's regulating procedures do "not contain any provisions authorizing agencies to grant summary judgment", they may do so when acting in a quasi-judicial role under the principle set down in *ASARCO*; and

WHEREAS, summary dismissal requests in the quasi-judicial realm are akin to summary judgment requests in the judicial realm. Washington's appellate courts have explained the standard of review to be applied in summary judgment requests.

When reviewing a summary judgment order, we engage in the same inquiry as the trial court, affirming summary judgment only if there is no genuine issue as to any material fact and the moving party is entitled to judgment as a matter of law. *City of Sequim v. Malkasian*, 157 Wn.2d 251, 261, 138 P.3d 943 (2006). All facts and reasonable inferences must be considered in the light most favorable to the nonmoving party, and summary judgment is appropriate only if reasonable minds could reach but one conclusion. *Dowler v. Clover Park Sch. Dist. No. 400*, 172 Wn.2d 471, 484, 258 P.3d 676 (2011).

Staples v. Allstate Insurance Co., __ Wn.2d __, __ P.3d __ (2013)

A nonmoving party in a summary judgment may not rely on speculation, argumentative assertions that unresolved factual issues remain, or in having its affidavits considered at face value; for after the moving party submits adequate affidavits, the nonmoving party must set forth specific facts that sufficiently rebut the moving party's contentions and disclose that a genuine issue as to a material fact exists.

Seven Gables Corp. v. MGM/UA Entertainment Co., 106 Wn.2d 1, 13, 721 P.2d 1 (1986); and

WHEREAS, City ordinances are subject to the same rules of interpretation and construction as apply to statutes. [*Neighbors v. King County*, 88 Wn. App. 773, 778, 946 P.2d 1188 (1997)] Courts, and by extension quasi-judicial decision makers, “do not construe a statute that is clear and unambiguous on its face. We assume that the legislature means exactly what it says, and we give words their plain and ordinary meaning. Statutes are construed as a whole, to give effect to all language and to harmonize all provisions.” [*Ockerman v. King Cy.*, 102 Wn. App. 212, 6 P.3rd 11214 (2000); see also: *Western Petroleum v. Freidt*, 127 Wn.2d 420, 424, 899 P.2d 792 (1995), holding that intent is relevant only if ambiguity exists in the language of the code; *State v. Azpitarte*, 140 Wn.2d 138, 141, 995 P.2d 31 (2000), holding that clear and unambiguous codes are not subject to judicial construction] Legislative history cannot override an unambiguous code provision. [*Kirtley v. State*, 49 Wn. App. 894, 898, 748 P.2d 1148 (1987)]; and

WHEREAS, the City is required to base its land use decisions upon duly adopted laws and ordinances, and may not consider equitable defenses. [*Chaussee v. Snohomish County*, 38 Wn. App. 630, 638, 689 P.2d 1084 (1984)]; and

WHEREAS, the Grove appeal challenges CP&D’s approval of a Critical Area Review 2 (“CAR 2”) for Strand’s proposed demolition and replacement of the existing residence at 6950 SE Maker Street; and

WHEREAS, there is no genuine issue regarding the following facts, derived from the documents listed above:

1. This appeal relates to a parcel whose mailing address is 6950 SE Maker Street, Mercer Island (“6950”). (Exhibit 9001.A, PDF 4)
2. 6950 is substantially, if not entirely, encumbered by regulated critical areas (steep slopes) and their required buffers. (Exhibit 9001.A, PDF 8)
3. Appellant Grove lives at 3515 72nd Avenue SE (“3515”), abutting 6950 on the east. (Exhibit 1, PDF 1)
4. The lots in this portion of Mercer Island were first platted in the 1890s. (Exhibit 9003.B, PDF 1)
5. The existing single-story, single-family residence was built in or around 1952. (Exhibit 9003.B, PDF 1)
6. The City of Mercer Island was incorporated on July 5, 1960. (Official notice)
7. 6950 was terraced before the residence was built, resulting in a fill slope along the west side of the lot. The fill slope was not initially rocked. (Exhibit 9005.D) The fill slope rises about 14.5 feet over a horizontal distance of about 30 feet, for an average slope of about 49 percent. (Exhibit 9005.C, PDF 5)
8. The western fill slope has since been rocked. (Exhibit 9005.B, PDF 5)
9. The western fill slope has a total maximum height (from toe to top) of about 14.5 feet. (Exhibit 9005.C, PDF 5)
10. 3515 also appears to have been terraced at some time in the past. The west edge of 3515, immediately east of the common boundary line with 6950, consists of a 5-foot tall Keystone wall topped by up to a 5-foot rockery. (Exhibit 9005.B, PDF 10)
11. The trunk of a Red oak tree (“Tree #5”) having a DSH (a.k.a. DBH) of approximately 45 inches and a height of 50 – 70 feet is rooted on 3515 approximately 10 feet east of the

- common boundary between 6950 and 3515. Some of Tree #5's branches hang over the common 6950/3515 property line. (Exhibits 9001.C; 9001.D; 9005.A; 9005.B)
12. Tree #5 meets the Mercer Island City Code ("MICC") definition of an "exceptional" tree. (Exhibit 9001.C, PDF 3)
 13. Strand first lived at 6950 in or around 2020. Strand purchased 6950 in 2021. (Exhibit 9005, PDF 1 & 2)
 14. In November 2021, Strand had a professional tree service remove all that portion of a large limb on Tree # 5 which overhung the common property line between 6950 and 3515. Grove was aware of and observed the removal of the branch. (Exhibit 9005, PDF 4)

; and

WHEREAS, the Grove appeal (Exhibit 9001.B) presents two issues (labeled as "Parts"). "Part 1" is discussed from PDF 3 – 8; "Part 2" is discussed from PDF 9 – 14. Issue 1 ("Part 1") asserts that Strand performed unpermitted exceptional tree removal within a critical area which must be addressed and resolved through the CAR 2 process. Issue 2 ("Part 2") asserts that the current topography of 6950 cannot be accepted as the existing lot grade for the purpose of building height calculation; and

WHEREAS, Issue 1 depends upon Grove's assertion that removal of the limb from Tree #5 constituted "cutting" (as opposed to "pruning"). Issue 1 can be resolved by applying applicable law to the agreed facts. Issue 1 is, thus, appropriate for summary dismissal consideration; and

WHEREAS, Tree #5 is located on Grove's 3515, not Strand's 6950. The CAR 2 was an application by Strand to perform certain work on 6950; a CAR 2 is not a code enforcement proceeding. A permit for work on 6950 cannot require Strand to do anything on a different lot which she doesn't own. For example, CP&D could not require Strand to preserve Tree #5 because Tree #5 is not Strand's tree on Strand's property. Nor, for the same reason, CP&D could not require Strand to physically remove Tree #5 in its entirety. For the simple reason that Tree #5 is not within the jurisdiction of the CAR 2 review under challenge, Issue 1 must be dismissed for lack of jurisdiction; and

WHEREAS, Issue 2 asserts that 6950's topographic configuration which has existed for at least the last 68 years cannot be considered as the "existing grade" of the lot. Grove argues that one must go back in history to pre-development times (whenever that might be), with the topography of the lot at that time constituting "existing grade" for current building height calculation purposes. Grove further asserts that the current rockery on the west side of 6950 was constructed after 1963 and was illegal when constructed. Issue 2 can be resolved by applying applicable law to the agreed facts. Issue 2 is, thus, appropriate for summary dismissal consideration; and

WHEREAS, the 1955 photograph (Exhibit 9005.D) shows clearly that the slope on the west side of 6950 has existed in its current configuration since at least 1955, five years before the City became incorporated. The slope was created before any Mercer Island zoning existed. It is clear from the current topography and the 1955 photograph that the rocks covering the western slope were placed on the slope as it existed in 1955. The rocks may well be protecting the slope from erosion, but they are not retaining the slope in the normal sense of a typical, near-vertical retaining wall; they are not a wall. Further, years ago CP&D

issued two Administrative Interpretations regarding the determination of “existing grade.” (Exhibits 9001.E; 9001.F) Both reach essentially the same conclusion:

without concrete evidence or verification from a previous survey document, as determined by the City Building Official, the existing grade of an existing structure or its various wall segments on a site will be used as the elevation for measuring average building elevation “prior to any development”.

(Exhibit 9001.F, PDF 3) No ancient survey has been presented to show what the terrain on 6950 was before any development occurred on the lot. (The lack of any such ancient survey is not unexpected given that the lot was developed before the City was incorporated.) The code interpretation controls: The existing grade is the grade to be used. Issue 2 must be dismissed based upon application of applicable law to the undisputed facts; and

WHEREAS, any Recital herein deemed to be either a Finding of Fact or a Conclusion of Law is hereby adopted as such.

NOW, THEREFORE, the Hearing Examiner issues the following:

ORDER

The appeal from CAO23-011 filed by Grove *et al.* on October 23, 2023 (Appeal APL23-009), is herewith **SUMMARILY DISMISSED** for the reasons set forth above.

The previously scheduled hearing, being moot, is herewith **CANCELED**.

This Order constitutes the Examiner’s final disposition of this appeal.

ORDER issued December 2, 2023.

\s\ John E. Galt

JOHN E. GALT
Hearing Examiner

NOTICE of RIGHT of RECONSIDERATION

This Order is final subject to the right of any party of record to file with the Department of Community Planning & Development a written request for reconsideration within ten calendar days following the issuance of this Order in accordance with the procedures of MICC 3.40.110. Any request for reconsideration must allege one or more of the following errors: “1. The decision was based in whole or in part on erroneous facts or information; 2. The decision when taken failed to comply with existing laws or

regulations applicable thereto; or 3. An error of procedure occurred that prevented consideration of the interests of persons directly affected by the decision.” [MICC 3.40.110(A)] See MICC 3.40.110 for additional information and requirements regarding reconsideration.

NOTICE of RIGHT of APPEAL

“Any judicial appeal of the hearing examiner’s decision shall be filed in King County superior court pursuant to Chapter 36.70C RCW, the Land Use Petition Act (‘LUPA’). The land use petition must be filed within 21 days of the issuance of the hearing examiner’s decision.” [MICC 3.40.100, ¶ 2]

The following statement is provided pursuant to RCW 36.70B.130: “Affected property owners may request a change in valuation for property tax purposes notwithstanding any program of revaluation.”

EXHIBIT I

June 6, 2023

JN 22007

Dorothy Strand
6950 Southeast Maker Street
Mercer Island, Washington 98040
via email: kcra2005@yahoo.com

Subject: **Review of Revised Plans**
Proposed New Residence
6950 Southeast Maker Street
Mercer Island, Washington

Dear Ms. Strand:

As required by the City of Mercer Island, we have completed a review of the geotechnical aspects of the revised plans for your proposed new residence. This revision to the plans addresses not only stabilization of the filled rockery on the west side of the site, but also providing protection for your residence in the event of future movement of the filled modular wall located on your eastern neighbor's lot.

Following discussions with you and your project team, partial removal of the western rockery combined with the installation of closely-spaced soldier piles behind the remaining portion of the rockery was chosen as the method to stabilize the fill located on the western portion of your property. This method substantially reduces the amount of site disturbance and earthwork, while providing stability for the filled rockery in the event of the Maximum Considered Earthquake (MCE). The design recommendations for this stabilization system are presented in our May 8, 2023 *Slope Stability Update*, which is attached for reference.

During this process, we were informed that it would not be possible to obtain permission to place fill against the eastern neighbor's filled modular block wall. We had previously recommended placing this fill buttress against the wall, as the wall was obviously not reinforced with geogrids, and would be inadequate to withstand a large earthquake. After discussing alternatives with your project team, it was decided to build a sloping fill up to the eastern property line, with a wall constructed at the property line to retain the fill within the site boundaries. This bermed fill will serve to absorb the impact from a potential future failure of the eastern neighbor's modular block wall.

Review of Plans:

We have been provided with the revised plans, which include the architectural plans (Jeffrey Almeter; June 2, 2023), shoring plans (Jeffrey Almeter and Buker Engineering; June 2, 2023), civil plans (Goldsmith Land Development Services; June 2, 2023), and the structural drawings (DS Engineering; February 2, 2023).

The shoring (SH) drawings correctly depict the partial removal of the existing western rockery, combined with the installation of closely-spaced soldier piles immediately behind the remaining lower portion of the rockery. The remaining lower approximately 5 feet of the rockery will no longer have to resist any lateral soil load, as this will be accomplished by the stabilization piles. This

system incorporates our recommendations to provide stability for the existing fill located on the west side of the lot.

The Site Plan and sections on SH1, as well as sheets C-2 and C-3, properly illustrate the fill berm and modular block wall to be constructed as protection against a potential failure of the eastern neighbor's modular block wall.

Where the new storm outfall pipe will extend to S.E. Maker Street, the existing rockery will be removed, and the ground will be lowered and regraded to a sloping condition between the end of the stabilization wall and the new driveway.

The plans that we reviewed have incorporated our recommendations for shoring, foundations, and permanent stability.

Statement of Risk: In order to satisfy the City of Mercer Island's requirements, a statement of risk is needed. As such, we make the following statement:

The landslide hazard area or seismic hazard area will be modified or the development has been designed so that the risk to the site and adjacent property is eliminated or mitigated such that the site is determined to be safe;

Please contact us if you have any questions regarding this letter.

Respectfully submitted,

GEOTECH CONSULTANTS, INC.



6/6/2023

Marc R. McGinnis, P.E.
Principal

Attachment: May 8, 2023 Slope Stability Update

cc: **Jeffrey Almeter**
via email: jeffrey.almeter@gmail.com

MRM:kg

May 8, 2023

JN 22007

Dorothy Strand
6950 Southeast Maker Street
Mercer Island, Washington 98040
via email: kcra2005@yahoo.com

Subject: **Slope Stability Update**
Proposed New Residence
6950 S.E. Maker Street
Mercer Island, Washington

Dear Ms. Strand:

As a part of the 2207-019-SUB1-PLANS REVIEW by City of Mercer Island, their geotechnical third-party reviewer made the following comment:

The geotechnical engineering report indicates "...due to the loose nature of the upper fill soils behind the rockery, it would only be considered moderately stable, and likely has a current factor of safety of 1.0 or slightly higher with regards to slope stability." Indicate how this hazard is being mitigated (MICC 19.07.160).

As we discussed in our previous response to this comment, the rockery in question existed before development of the adjacent western property. The planned redevelopment of your lot with a new home would not adversely impact the stability of this filled rockery, and may actually improve its stability slightly by collecting all runoff from impervious surfaces and discharging it to the storm sewer.

No mitigation of this potential hazard was included in the neighboring construction. It is likely that excavation for that house would have extended into the influence zone of that rockery, and the front entry and entry walk were placed close to the base of the rockery.

Following our meeting with City of Mercer Island staff, we understand that they are interpreting Mercer Island Code to require that the risk of potential future failure of the old filled rockery located along the western side of your lot is to be mitigated for the planned redevelopment of your property. The most likely cause of any potential future movement of the filled rockery would be a moderate to large earthquake.

With you and your design team, we have discussed several different methods to provide stability of the fill behind the western rockery under both static and seismic (Maximum Considered Earthquake with a 2% chance of occurring in 50 years) conditions. Based on these discussions, and our review of the site conditions for equipment and truck access, it appears most practical to install a line of closely-spaced stabilization piles immediately behind the western rockery. These piles would retain the loose fill soils behind the rockery and provide stability for the fill in the event of an earthquake. In conjunction with the construction of this stabilization wall, the uppermost 4 to 5 feet of the existing rockery would be removed. This will create a level bench for the installation of the drilled piles. The upper 4 to 5 feet of the stabilization piles would then be lagged and backfilled to restore the ground surface elevation in the western yard area.

Based on our previous stability assessments, a theoretical failure could have extended through the toe of the existing rockery in the event of the low probability Maximum Considered Earthquake. The stabilization piles should be designed to resist active and seismic earth pressures to that depth, with passive soil pressure in the competent glacial till resisting the lateral earth loads below that depth.

The following section has design recommendations for the stabilization wall consisting of closely-spaced soldier piles.

STABILIZATION WALL

The stabilization wall should consist of closely spaced, drilled soldier piles spaced no further apart than 3 feet edge-to-edge. The soil within the stabilization zone will arch between the piles if a failure does in fact occur on the eastern slope. The piles could be installed by drilling them to depth. It is likely that a debris barrier, potentially consisting of plywood spanning between metal posts, with need to be installed along the western side of the work area to prevent drill spoils from falling onto the neighboring property.

There will be no need for a subsurface drain behind the stabilization wall. Any small amounts of groundwater that currently travel laterally below the ground surface will pass between the piles.

The stabilization wall should be designed for an active soil pressure equal to that pressure exerted by an equivalent fluid with a unit weight of 40 pounds per cubic foot (pcf) if it retains level soil. A seismic surcharge of $8H$ pounds per square foot (psf) should be applied also. In this case H is the effective design retention height, which extends to the base of the existing rockery. An ultimate (no safety factor included) passive soil pressure equal to that pressure exerted by a fluid with a density of 450 pcf will resist the lateral movement of the piles below the stabilization depth. This passive resistance can be assumed to act over twice the width of the wide-flange beams. Typically, a safety factor of 1.5 is applied to the ultimate passive resistance for static conditions, and 1.1 to 1.2 for seismic loading conditions.

Please contact us if you have any questions regarding this letter.

Respectfully submitted,
GEOTECH CONSULTANTS, INC.



5/8/2023

Marc R. McGinnis, P.E.
Principal

Attachments:

- Slope Stability Analyses

cc: **Jeffrey Almeter** - via email: jeffrey.almeter@gmail.com

22007 - Strand

Cross Section

Materials	
	Loose FILL
	Medium-Dense Silty SAND
	Dense GLACIAL TILL

Name: Loose FILL
 Unit Weight: 120 pcf
 Cohesion: 0 psf
 Phi: 30 °

Name: Medium-Dense Silty SAND
 Unit Weight: 125 pcf
 Cohesion: 0 psf
 Phi: 34 °

Name: Dense GLACIAL TILL
 Unit Weight: 140 pcf
 Cohesion: 100 psf
 Phi: 40 °

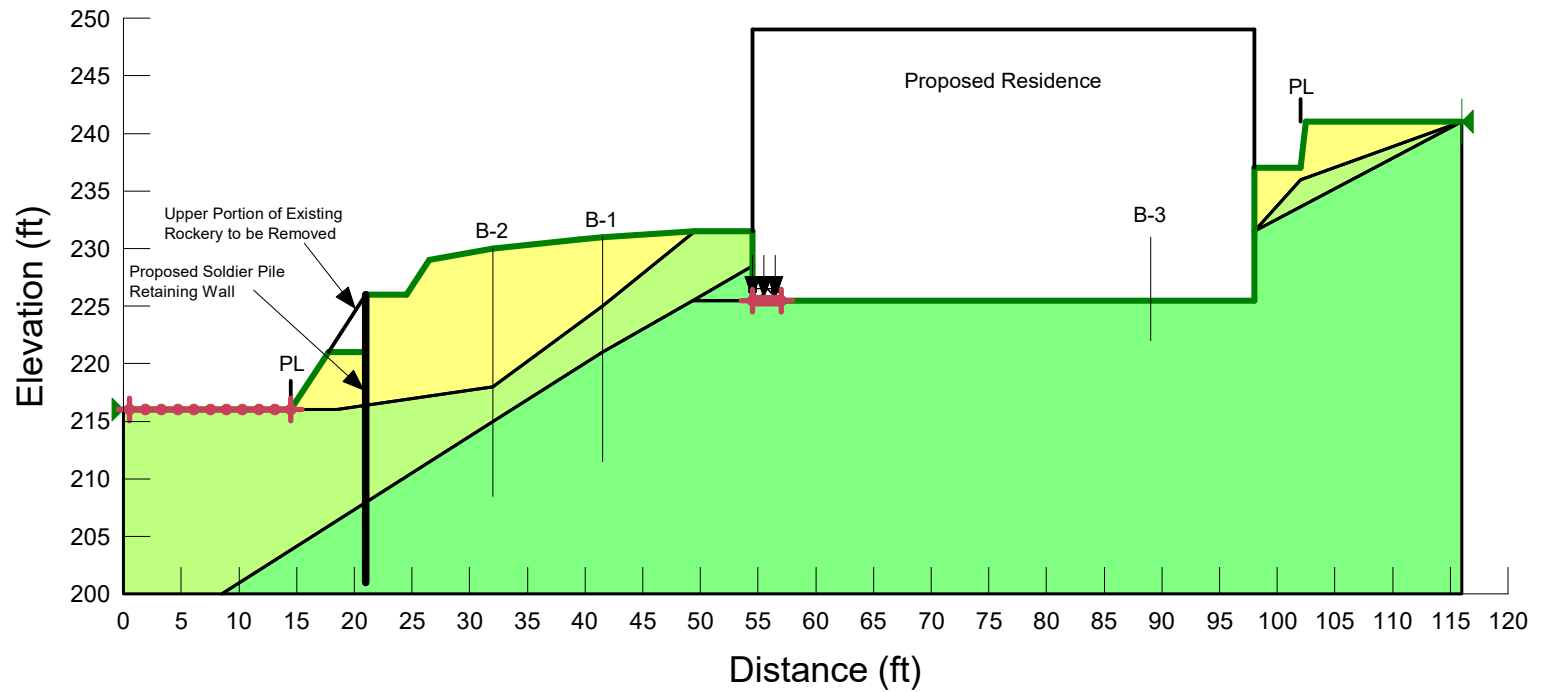

22007 - Strand

Static

Materials	
	Loose FILL
	Medium-Dense Silty SAND
	Dense GLACIAL TILL

Name: Loose FILL
 Unit Weight: 120 pcf
 Cohesion: 0 psf
 Phi: 30 °

Name: Medium-Dense Silty SAND
 Unit Weight: 125 pcf
 Cohesion: 0 psf
 Phi: 34 °

Name: Dense GLACIAL TILL
 Unit Weight: 140 pcf
 Cohesion: 100 psf
 Phi: 40 °

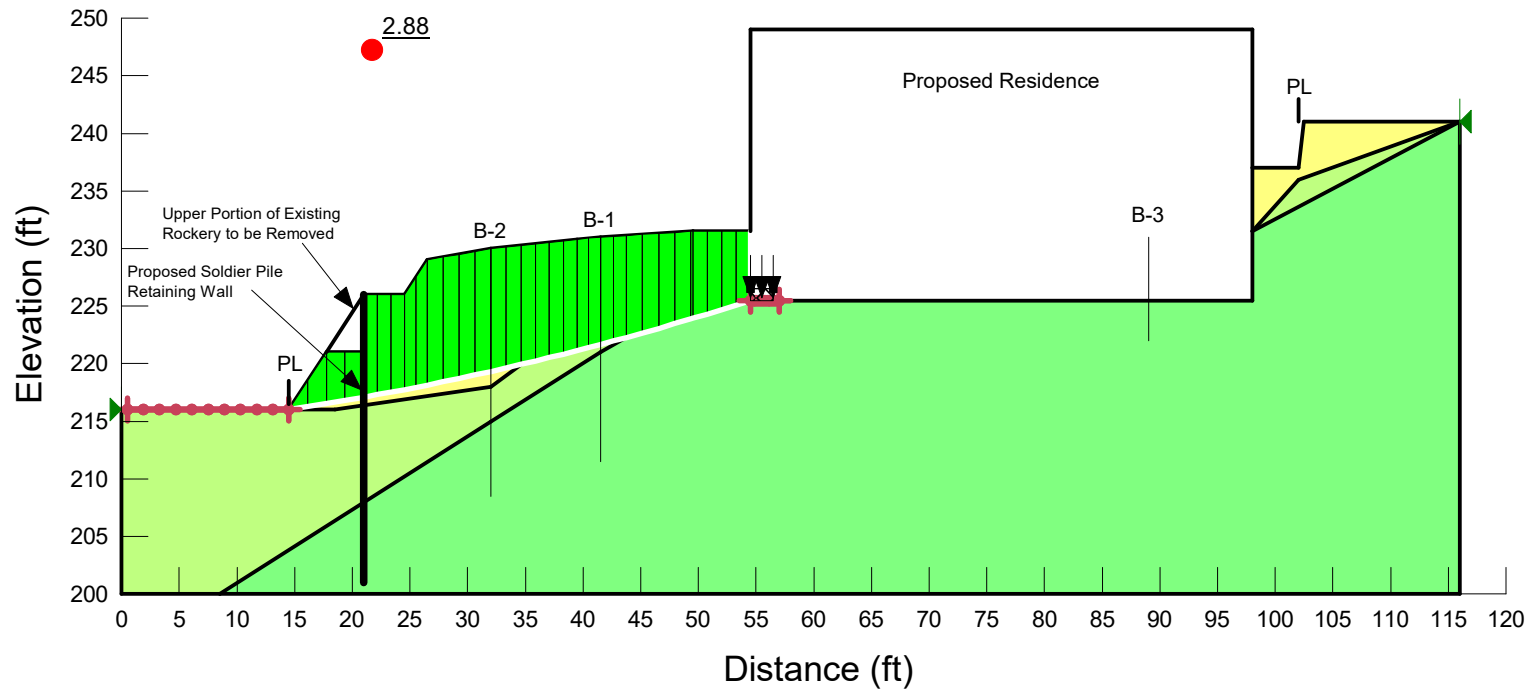

Static

Report generated using GeoStudio 2012. Copyright © 1991-2016 GEO-SLOPE International Ltd.

File Information

File Version: 8.15

Title: 22007 Slope Stability Analysis

Created By: Adam Moyer

Last Edited By: Adam Moyer

Revision Number: 64

Date: 5/3/2023

Time: 6:17:03 PM

Tool Version: 8.15.6.13446

File Name: 22007 Slope Stability Analysis - Strand (Soldier Piles).gsz

Directory: C:\Users\AdamM\Geotech Consultants\Shared Documents - Documents\2022 Jobs\22007 Strand (MRM)\

Last Solved Date: 5/3/2023

Last Solved Time: 6:17:05 PM

Project Settings

Length(L) Units: Feet

Time(t) Units: Seconds

Force(F) Units: Pounds

Pressure(p) Units: psf

Strength Units: psf

Unit Weight of Water: 62.4 pcf

View: 2D

Element Thickness: 1

Analysis Settings

Static

Kind: SLOPE/W

Method: Morgenstern-Price

Settings

Side Function

Interslice force function option: Half-Sine

PWP Conditions Source: (none)

Slip Surface

Direction of movement: Right to Left

Use Passive Mode: No

Slip Surface Option: Entry and Exit

Critical slip surfaces saved: 1

Resisting Side Maximum Convex Angle: 1 °

Driving Side Maximum Convex Angle: 5 °

Optimize Critical Slip Surface Location: [No](#)

Tension Crack

Tension Crack Option: [\(none\)](#)

F of S Distribution

F of S Calculation Option: [Constant](#)

Advanced

Number of Slices: [30](#)

F of S Tolerance: [0.001](#)

Minimum Slip Surface Depth: [0.1 ft](#)

Search Method: [Root Finder](#)

Tolerable difference between starting and converged F of S: [3](#)

Maximum iterations to calculate converged lambda: [20](#)

Max Absolute Lambda: [2](#)

Materials

Loose FILL

Model: [Mohr-Coulomb](#)

Unit Weight: [120 pcf](#)

Cohesion': [0 psf](#)

Phi': [30 °](#)

Phi-B: [0 °](#)

Medium-Dense Silty SAND

Model: [Mohr-Coulomb](#)

Unit Weight: [125 pcf](#)

Cohesion': [0 psf](#)

Phi': [34 °](#)

Phi-B: [0 °](#)

Dense GLACIAL TILL

Model: [Mohr-Coulomb](#)

Unit Weight: [140 pcf](#)

Cohesion': [100 psf](#)

Phi': [40 °](#)

Phi-B: [0 °](#)

Slip Surface Entry and Exit

Left Projection: [Range](#)

Left-Zone Left Coordinate: [\(0.5, 216\) ft](#)

Left-Zone Right Coordinate: [\(14.5, 216\) ft](#)

Left-Zone Increment: [10](#)

Right Projection: [Range](#)

Right-Zone Left Coordinate: [\(54.5, 225.5\) ft](#)

Right-Zone Right Coordinate: [\(57, 225.5\) ft](#)

Right-Zone Increment: [10](#)

Radius Increments: 10

Slip Surface Limits

Left Coordinate: (0, 216) ft

Right Coordinate: (116, 241) ft

Surcharge Loads

Surcharge Load 1

Surcharge (Unit Weight): 3,000 pcf

Direction: Vertical

Coordinates

	X (ft)	Y (ft)
	54.5	226.5
	56.5	226.5

Points

	X (ft)	Y (ft)
Point 1	0	216
Point 2	14.5	216
Point 3	18.5	216
Point 4	21	226
Point 5	24.5	226
Point 6	26.5	229
Point 7	32	230
Point 8	41.5	231
Point 9	54.5	231.5
Point 10	89	231.5
Point 11	98	231.5
Point 12	98	237
Point 13	102	237
Point 14	102.5	241
Point 15	116	241
Point 16	0	200
Point 17	116	200
Point 18	41.5	225
Point 19	41.5	221
Point 20	41.5	211.5
Point 21	32	218
Point 22	32	215
Point 23	32	208.5
Point 24	89	228
Point 25	89	222

Point 26	8.5	200
Point 27	102	236
Point 28	54.5	225.5
Point 29	49.35714	225.5
Point 30	98	225.5
Point 31	49.5	231.5
Point 32	54.5	228.5
Point 33	39.5	230.78947
Point 34	39.5	226
Point 35	24.5	221
Point 36	17.75	221
Point 37	21	221

Regions

	Material	Points	Area (ft ²)
Region 1	Dense GLACIAL TILL	26,22,19,29,28,30,11,15,17	2,422.8
Region 2	Loose FILL	11,12,13,14,15,27	47
Region 3	Medium-Dense Silty SAND	11,27,15	21.5
Region 4	Medium-Dense Silty SAND	1,16,26,22,19,29,32,9,31,18,21,3,2	444.46
Region 5	Dense GLACIAL TILL	29,28,32	7.7143
Region 6	Loose FILL	2,36,37,4,5,6,7,33,8,31,18,21,3	252.62

Current Slip Surface

Slip Surface: 1,211

F of S: 2.88

Volume: 326.12155 ft³

Weight: 39,826.943 lbs

Resisting Moment: 7,039,834.2 lbs-ft

Activating Moment: 2,442,671.4 lbs-ft

Resisting Force: 26,195.096 lbs

Activating Force: 9,086.373 lbs

F of S Rank (Analysis): 1 of 1,331 slip surfaces

F of S Rank (Query): 1 of 1,331 slip surfaces

Exit: (14.5, 216) ft

Entry: (54.5, 225.5) ft

Radius: 260.50867 ft

Center: (-25.508672, 473.41809) ft



Slip Slices

	X (ft)	Y (ft)	PWP (psf)	Base Normal Stress (psf)	Frictional Strength (psf)	Cohesive Strength (psf)
Slice 1	15.3125	216.12891	0	130.3198	75.24017	0
Slice 2	16.9375	216.392	0	389.65597	224.96798	0
Slice 3	18.5625	216.66564	0	502.09014	289.88188	0
Slice 4	20.1875	216.94987	0	468.40576	270.43419	0
Slice 5	21.583333	217.20186	0	1,016.9121	587.11447	0

Slice 6	22.75	217.41904	0	990.97995	572.14254	0
Slice 7	23.916667	217.64172	0	964.57018	556.89485	0
Slice 8	25	217.85326	0	1,026.1775	592.46385	0
Slice 9	26	218.05293	0	1,175.7195	678.80196	0
Slice 10	27.1875	218.29579	0	1,248.0613	720.56852	0
Slice 11	28.5625	218.58367	0	1,243.1162	717.71349	0
Slice 12	29.9375	218.8793	0	1,237.3377	714.37727	0
Slice 13	31.3125	219.18272	0	1,230.6767	710.53152	0
Slice 14	32.66155	219.48792	0	1,217.4169	702.87598	0
Slice 15	33.984649	219.79465	0	1,197.5562	691.4094	0
Slice 16	35.252924	220.09536	0	1,166.3245	786.69579	0
Slice 17	36.466374	220.38949	0	1,149.4162	775.29099	0
Slice 18	37.679825	220.6898	0	1,131.7434	763.37059	0
Slice 19	38.893275	220.99629	0	1,113.2802	750.91698	0
Slice 20	40	221.281	0	1,095.7635	739.10185	0
Slice 21	41	221.54293	0	1,079.3145	728.00684	0
Slice 22	42.059146	221.82512	0	1,058.7441	714.13192	0
Slice 23	43.177438	222.12812	0	1,033.9776	697.4267	0
Slice 24	44.439154	222.47679	0	978.55527	821.10536	100
Slice 25	45.844293	222.87271	0	952.63834	799.35848	100
Slice 26	47.249432	223.27715	0	925.64169	776.7056	100
Slice 27	48.654571	223.69015	0	897.53754	753.12342	100
Slice 28	49.42857	223.92025	0	881.7284	739.85797	100
Slice 29	50.125	224.13133	0	860.41948	721.97767	100
Slice 30	51.375	224.51401	0	820.33679	688.3443	100
Slice 31	52.625	224.90357	0	779.3911	653.98678	100
Slice 32	53.875	225.30004	0	737.58834	618.9101	100

22007 - Strand

Seismic

Materials	
	Loose FILL
	Medium-Dense Silty SAND
	Dense GLACIAL TILL

Name: Loose FILL
 Unit Weight: 120 pcf
 Cohesion: 0 psf
 Phi: 30 °

Name: Medium-Dense Silty SAND
 Unit Weight: 125 pcf
 Cohesion: 0 psf
 Phi: 34 °

Name: Dense GLACIAL TILL
 Unit Weight: 140 pcf
 Cohesion: 100 psf
 Phi: 40 °

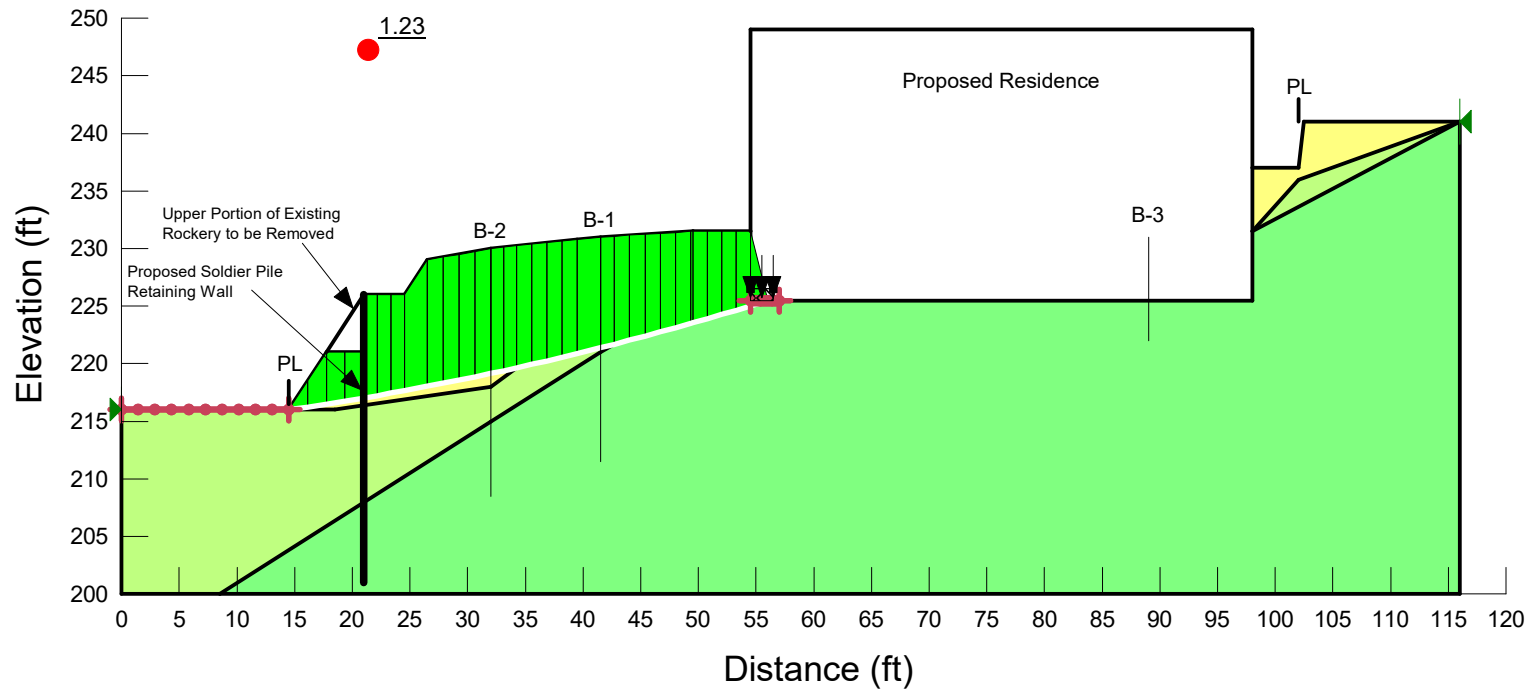

Seismic

Report generated using GeoStudio 2012. Copyright © 1991-2016 GEO-SLOPE International Ltd.

File Information

File Version: 8.15
Title: 22007 Slope Stability Analysis
Created By: Adam Moyer
Last Edited By: Adam Moyer
Revision Number: 64
Date: 5/3/2023
Time: 6:17:03 PM
Tool Version: 8.15.6.13446
File Name: 22007 Slope Stability Analysis - Strand (Soldier Piles).gsz
Directory: C:\Users\AdamM\Geotech Consultants\Shared Documents - Documents\2022 Jobs\22007 Strand (MRM)\
Last Solved Date: 5/3/2023
Last Solved Time: 6:17:07 PM

Project Settings

Length(L) Units: Feet
Time(t) Units: Seconds
Force(F) Units: Pounds
Pressure(p) Units: psf
Strength Units: psf
Unit Weight of Water: 62.4 pcf
View: 2D
Element Thickness: 1

Analysis Settings

Seismic

Kind: SLOPE/W
Method: Morgenstern-Price
Settings
Side Function
Interslice force function option: Half-Sine
PWP Conditions Source: (none)
Slip Surface
Direction of movement: Right to Left
Use Passive Mode: No
Slip Surface Option: Entry and Exit
Critical slip surfaces saved: 1
Resisting Side Maximum Convex Angle: 1 °
Driving Side Maximum Convex Angle: 5 °

Optimize Critical Slip Surface Location: [No](#)

Tension Crack

Tension Crack Option: [\(none\)](#)

F of S Distribution

F of S Calculation Option: [Constant](#)

Advanced

Number of Slices: [30](#)

F of S Tolerance: [0.001](#)

Minimum Slip Surface Depth: [0.1 ft](#)

Search Method: [Root Finder](#)

Tolerable difference between starting and converged F of S: [3](#)

Maximum iterations to calculate converged lambda: [20](#)

Max Absolute Lambda: [2](#)

Materials

Loose FILL

Model: [Mohr-Coulomb](#)

Unit Weight: [120 pcf](#)

Cohesion': [0 psf](#)

Phi': [30 °](#)

Phi-B: [0 °](#)

Medium-Dense Silty SAND

Model: [Mohr-Coulomb](#)

Unit Weight: [125 pcf](#)

Cohesion': [0 psf](#)

Phi': [34 °](#)

Phi-B: [0 °](#)

Dense GLACIAL TILL

Model: [Mohr-Coulomb](#)

Unit Weight: [140 pcf](#)

Cohesion': [100 psf](#)

Phi': [40 °](#)

Phi-B: [0 °](#)

Slip Surface Entry and Exit

Left Projection: [Range](#)

Left-Zone Left Coordinate: [\(0, 216\) ft](#)

Left-Zone Right Coordinate: [\(14.5, 216\) ft](#)

Left-Zone Increment: [10](#)

Right Projection: [Range](#)

Right-Zone Left Coordinate: [\(54.53697, 225.5\) ft](#)

Right-Zone Right Coordinate: [\(57, 225.5\) ft](#)

Right-Zone Increment: [10](#)

Radius Increments: 20

Slip Surface Limits

Left Coordinate: (0, 216) ft

Right Coordinate: (116, 241) ft

Surcharge Loads

Surcharge Load 1

Surcharge (Unit Weight): 3,000 pcf

Direction: Vertical

Coordinates

	X (ft)	Y (ft)
	54.5	226.5
	56.5	226.5

Seismic Coefficients

Horz Seismic Coef.: 0.333

Points

	X (ft)	Y (ft)
Point 1	0	216
Point 2	14.5	216
Point 3	18.5	216
Point 4	21	226
Point 5	24.5	226
Point 6	26.5	229
Point 7	32	230
Point 8	41.5	231
Point 9	54.5	231.5
Point 10	89	231.5
Point 11	98	231.5
Point 12	98	237
Point 13	102	237
Point 14	102.5	241
Point 15	116	241
Point 16	0	200
Point 17	116	200
Point 18	41.5	225
Point 19	41.5	221
Point 20	41.5	211.5
Point 21	32	218

Point 22	32	215
Point 23	32	208.5
Point 24	89	228
Point 25	89	222
Point 26	8.5	200
Point 27	102	236
Point 28	54.5	225.5
Point 29	49.35714	225.5
Point 30	98	225.5
Point 31	49.5	231.5
Point 32	54.5	228.5
Point 33	39.5	230.78947
Point 34	39.5	226
Point 35	24.5	221
Point 36	17.75	221
Point 37	21	221

Regions

	Material	Points	Area (ft ²)
Region 1	Dense GLACIAL TILL	26,22,19,29,28,30,11,15,17	2,422.8
Region 2	Loose FILL	11,12,13,14,15,27	47
Region 3	Medium-Dense Silty SAND	11,27,15	21.5
Region 4	Medium-Dense Silty SAND	1,16,26,22,19,29,32,9,31,18,21,3,2	444.46
Region 5	Dense GLACIAL TILL	29,28,32	7.7143
Region 6	Loose FILL	2,36,37,4,5,6,7,33,8,31,18,21,3	252.62

Current Slip Surface

Slip Surface: 2,437

F of S: 1.23

Volume: 335.14206 ft³

Weight: 41,016.233 lbs

Resisting Moment: 7,816,151.8 lbs-ft

Activating Moment: 6,329,166.7 lbs-ft

Resisting Force: 28,364.767 lbs

Activating Force: 22,978.623 lbs

F of S Rank (Analysis): 1 of 2,541 slip surfaces

F of S Rank (Query): 1 of 2,541 slip surfaces

Exit: (14.5, 216) ft

Entry: (56.014788, 225.5) ft

Radius: 267.59565 ft

Center: (-24.245383, 480.77581) ft

Slip Slices

	X (ft)	Y (ft)	PWP (psf)	Base Normal Stress (psf)	Frictional Strength (psf)	Cohesive Strength (psf)
Slice 1	15.3125	216.12144	0	127.61968	73.681258	0

Slice 2	16.9375	216.36944	0	385.93709	222.82088	0
Slice 3	18.5625	216.62767	0	506.05186	292.16918	0
Slice 4	20.1875	216.89615	0	483.92787	279.39589	0
Slice 5	21.583333	217.13436	0	1,048.034	605.08273	0
Slice 6	22.75	217.33983	0	1,038.0148	599.29813	0
Slice 7	23.916667	217.55062	0	1,026.7199	592.77699	0
Slice 8	25.5	217.84655	0	1,187.6527	685.69161	0
Slice 9	27.1875	218.1704	0	1,361.8933	786.28945	0
Slice 10	28.5625	218.44344	0	1,370.9793	791.5353	0
Slice 11	29.9375	218.72399	0	1,375.1612	793.94967	0
Slice 12	31.3125	219.01206	0	1,374.473	793.55233	0
Slice 13	32.559552	219.27953	0	1,364.6292	787.86903	0
Slice 14	33.678655	219.52514	0	1,346.7008	777.51808	0
Slice 15	34.89593	219.79825	0	1,186.7347	800.46263	0
Slice 16	36.211379	220.09985	0	1,162.6433	784.21278	0
Slice 17	37.526827	220.40843	0	1,138.5167	767.93922	0
Slice 18	38.842276	220.72404	0	1,113.5438	751.09476	0
Slice 19	40.5	221.13296	0	1,078.7191	727.60522	0
Slice 20	42.103438	221.53677	0	1,037.3242	699.68404	0
Slice 21	43.371903	221.86489	0	775.7868	650.96242	100
Slice 22	44.701956	222.2159	0	759.75205	637.50767	100
Slice 23	46.032008	222.57425	0	741.24307	621.97679	100
Slice 24	47.362061	222.93995	0	719.99806	604.15011	100
Slice 25	48.692114	223.31304	0	696.15487	584.14329	100
Slice 26	49.42857	223.52189	0	682.11062	572.35877	100
Slice 27	50.125	223.72318	0	661.96447	555.45414	100
Slice 28	51.375	224.08813	0	623.49376	523.17339	100
Slice 29	52.625	224.45969	0	583.53148	489.64105	100
Slice 30	53.875	224.8379	0	542.25987	455.01006	100
Slice 31	55.257394	225.26434	0	2,310.0591	1,938.3698	100